



OPERATING INSTRUCTIONS

EN

Translation of the Original

ASI 35

Integrable industrial leak detector

Disclaimer of liability

These operating instructions describe all models and variants of your product. Note that your product may not be equipped with all features described in this document. Pfeiffer Vacuum constantly adapts its products to the latest state of the art without prior notice. Please take into account that online operating instructions can deviate from the printed operating instructions supplied with your product.

Furthermore, Pfeiffer Vacuum assumes no responsibility or liability for damage resulting from the use of the product that contradicts its proper use or is explicitly defined as foreseeable misuse.

Copyright

This document is the intellectual property of Pfeiffer Vacuum and all contents of this document are protected by copyright. They may not be copied, altered, reproduced or published without the prior written permission of Pfeiffer Vacuum.

We reserve the right to make changes to the technical data and information in this document.

Table of contents

1	About this manual	7
1.1	Validity	7
	1.1.1 Products concerned	7
	1.1.2 Applicable documents	7
1.2	Target group	7
1.3	Conventions	7
	1.3.1 Pictographs	7
	1.3.2 Instructions in the text	8
	1.3.3 Labels	8
	1.3.4 Abbreviations	10
2	Safety	11
2.1	General safety information	11
	2.1.1 Safety instructions	11
	2.1.2 Precautions	13
2.2	Intended use	13
2.3	Foreseeable misuse	13
3	Transportation and Storage	15
3.1	Receipt of the product	15
3.2	Handling	15
3.3	Storage	15
4	Product description	17
4.1	Product identification	17
4.2	Scope of delivery	17
4.3	Product overview	17
	4.3.1 Vacuum module	17
	4.3.2 Electronic module	18
	4.3.3 Industrial control panel (option/accessory)	18
4.4	Connection interface	19
4.5	Test methods	20
	4.5.1 Hard vacuum test	20
	4.5.2 Sniffer test	20
4.6	Control panel description	21
5	Installation	22
5.1	Securing the modules	22
	5.1.1 Attaching the vacuum module	22
	5.1.2 Attaching the electronic module	23
	5.1.3 Attaching the industrial control panel	25
5.2	Connecting the installation to be tested	27
	5.2.1 Prerequisites for optimizing measurement	27
	5.2.2 Installation instructions to be observed	27
	5.2.3 Vacuum circuit of the vacuum module	28
	5.2.4 Connection of the primary pump	29
	5.2.5 Gross Leak mode port connection	30
	5.2.6 Normal mode port connection	31
	5.2.7 High Sensitivity mode port connection	32
	5.2.8 Connection on the Gross Leak, Normal and High Sensitivity mode ports	33
	5.2.9 Connection in Sniffer mode	34
5.3	Electrical connection	34
5.4	Connecting the exhaust	34
5.5	Gauge connection (accessory)	35
	5.5.1 Installation	35

	5.5.2 Setting	36
	5.5.3 Atmospheric pressure/ Limit pressure adjustments	37
6	Commissioning	38
	6.1 Start-up of the detector	38
	6.2 Detector powering off	38
	6.3 Familiarize yourself with the control panel	38
7	Operation	39
	7.1 Use conditions	39
	7.2 Prerequisites for optimizing use	39
	7.3 Operation monitoring	39
	7.4 Test Start/Stop	40
	7.5 Calibration	41
	7.5.1 Calibration in hard vacuum test mode with internal calibrated leak	42
	7.5.2 Calibration in hard vacuum test mode with external calibrated leak	42
	7.5.3 Calibration in hard vacuum test mode with machine calibration	42
	7.5.4 Calibration in hard vacuum test with a pumping system in parallel	43
	7.5.5 Calibration in sniffer test with external calibrated leak	44
	7.5.6 Calibration in sniffer test on concentration	45
	7.5.7 Dynamic calibration	45
	7.5.8 Calibration check	45
	7.6 Zero Function	45
	7.7 Touchscreen	45
	7.7.1 Navigation	46
	7.7.2 Main screen (home)	47
	7.7.3 Graph screen	48
	7.7.4 Graph screen: graph parameters	48
	7.7.5 Graph screen: graph clearing	49
	7.7.6 Graph screen: recording a graph	49
	7.7.7 Graph screen: scales	50
	7.7.8 Graph screen: saving a recording	51
	7.7.9 Graph screen: viewing a recording	52
	7.7.10 Settings screen	53
	7.7.11 Synoptic screen	53
	7.7.12 'Measurement' window	54
8	Settings	55
	8.1 Set points menu	56
	8.1.1 Audio alarm and digital voice	56
	8.1.2 Pollution function	56
	8.1.3 Background maximum	57
	8.1.4 Hard vacuum reject point	57
	8.1.5 Sniffer reject point	58
	8.1.6 Probe clogged threshold	58
	8.1.7 Other pressure set points	59
	8.2 Test menu	60
	8.2.1 Test method	60
	8.2.2 Correction factor	60
	8.2.3 Test mode	61
	8.2.4 Probe type	62
	8.2.5 Automatic cycle end	62
	8.2.6 Zero activation	62
	8.2.7 Memo function	63
	8.3 Spectro menu	64
	8.3.1 Tracer gas	64
	8.3.2 Filament parameters	65
	8.3.3 Calibrated leak	65
	8.4 Maintenance menu	66

8.4.1	Detector	66
8.4.2	Timers	66
8.4.3	Detector information	68
8.4.4	Pump Information	68
8.4.5	Event history	69
8.4.6	Calibration history	70
8.4.7	Last maintenance	70
8.5	Configuration menu	70
8.5.1	Time – Date – Unit – Language	70
8.5.2	Function keys	71
8.5.3	Application windows	72
8.5.4	Screen settings	74
8.5.5	Access – Password	75
8.6	Advanced menu	78
8.6.1	Leak Detection: Start Up timer	78
8.6.2	Leak Detection: Detector pressure gauge	78
8.6.3	Leak Detection: External gauge	79
8.6.4	Leak Detection: Calibration	80
8.6.5	Leak Detection: Analyzer cell	81
8.6.6	Leak Detection: Dynamic calibration	81
8.6.7	Leak Detection: Signal processing	83
8.6.8	Input/Output: Serial link 1 and Serial link 2	83
8.6.9	Input/Output: I/O connector	84
8.6.10	Secondary Pump Speed	84
8.6.11	SD Card menu	85
8.6.12	Service	85
9	Maintenance/Replacement	86
10	Service solutions by Pfeiffer Vacuum	87
11	Accessories	89
12	Technical data and dimensions	90
12.1	General	90
12.2	Technical characteristics	90
12.3	Units of pressure	91
12.4	Gas throughputs	91
12.5	Dimensions	92
13	Annex	93
13.1	ASI 20 MD / ASI 30 / ASI35 specific features	93
13.2	Tree diagram of the Settings menu	94
	EC Declaration of Conformity	106
	UK Declaration of Conformity	107

List of tables

Tbl. 1:	Units of pressure and their conversion	91
Tbl. 2:	Gas throughputs and their conversion	91
Tbl. 3:	Default settings: 'Set Points' menu	95
Tbl. 4:	Default settings: 'Test' menu	96
Tbl. 5:	Default settings: 'Spectro' menu	97
Tbl. 6:	Default settings: 'Maintenance' menu	98
Tbl. 7:	Default settings: 'Configuration' menu	101
Tbl. 8:	Default settings: 'Advanced' menu	104
Tbl. 9:	Initial settings: Graph screen - Graph parameters	105

1 About this manual



IMPORTANT

Read carefully before use.
Keep the manual for future consultation.

1.1 Validity

These operating instructions are a customer document of Pfeiffer Vacuum. The operating instructions describe the functions of the named product and provide the most important information for the safe use of the device. The description is written in accordance with the valid directives. The information in these operating instructions refers to the product's current development status. The document shall remain valid provided that the customer does not make any changes to the product.

1.1.1 Products concerned

This document applies to products with the following part numbers:

Part Number	Description
Sxxx0x0xMM9A	ASI 35 (all models)

1.1.2 Applicable documents

Document	Part Number
Operating instructions - Detection communication interface	130417 ¹⁾
Operating instructions - Internal calibration kit	123588 ¹⁾
Operating instructions - Sniffer kit	123589 ¹⁾
Operating instructions - Standard sniffer probe	121780 ¹⁾
Operating Instructions - Smart sniffer probe	BG5268 ¹⁾
Operating instructions - Spray gun	121781 ¹⁾
Operating instructions - ASI 20 MD module	123358 ¹⁾
2xxx/3xxx module - Operating instructions	123359 ¹⁾
ASI 35 Maintenance instructions	127801M
EC Declaration of conformity	Included with these instructions

¹⁾ also available at www.pfeiffer-vacuum.com

1.2 Target group

This user manual is intended for all persons in charge of transport, installation, commissioning/decommissioning, use, maintenance or storage of the product.

The work described in this document must only be carried out by persons with suitable technical training (specialized staff) or persons who have undergone Pfeiffer Vacuum training.

1.3 Conventions

1.3.1 Pictographs

Pictographs used in the document indicate useful information.



Note



Tip



Key point on the illustration to be checked



Stated tightening torque to be applied



Respect the chronological order of operations and/or assembly/disassembly direction

1.3.2 Instructions in the text

Usage instructions in the document follow a general structure that is complete in itself. The required action is indicated by an individual step or multi-part action steps.

Individual action step

A horizontal, solid triangle indicates the only step in an action.

- ▶ This is an individual action step.

Sequence of multi-part action steps

The numerical list indicates an action with multiple necessary steps.

1. Step 1
2. Step 2
3. ...

1.3.3 Labels

INPUTS/OUTPUTS	Inputs/Outputs communication interface connector
SERIAL	9-pin D-Sub RS-232 serial link connector
NETWORK	Ethernet plug
USB	USB plug
MAIN POWER	Power supply
CONTROL PANEL	Control panel
PRESSURE	Pressure
VACUUM BLOCK	Vacuum block
ACCESSORIES	Accessories
HIGH SENS	High Sensitivity mode
NORMAL	Normal mode
GROSS	Gross Leak mode
FOREPUMP	Roughing pump
90/240V 50-60Hz Max 300W	Operating voltage - Use frequency - Maximum power consumption

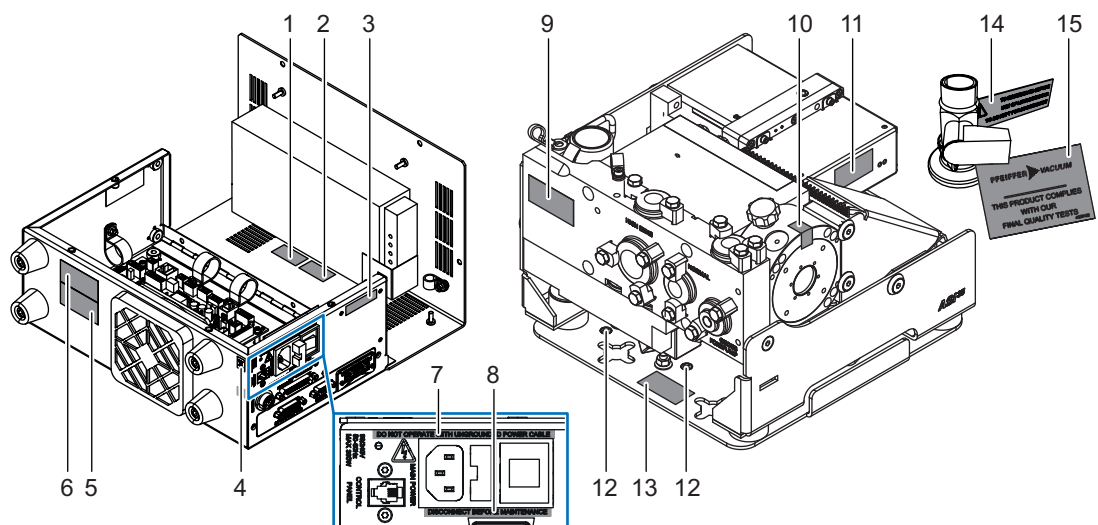

Packaging



-	FR AEOF 00165062 - assurance qualité / quality control	This label guarantees to the user that the product packaging has not been opened since leaving the factory.
---	--	---

Electronic module

1	<table border="1"> <tr> <td>Pu_GL : 1</td> <td>Pu_N : 1</td> </tr> <tr> <td>Mu_GL : 12856</td> <td>Mu_N : 31</td> </tr> <tr> <td colspan="2">.....</td> </tr> <tr> <td>Mu_Cal : 1</td> <td>Mu_LDS : 1800</td> </tr> </table> <p>(Example)</p>	Pu_GL : 1	Pu_N : 1	Mu_GL : 12856	Mu_N : 31		Mu_Cal : 1	Mu_LDS : 1800	For service centers use only															
Pu_GL : 1	Pu_N : 1																								
Mu_GL : 12856	Mu_N : 31																								
.....																									
Mu_Cal : 1	Mu_LDS : 1800																								
2	<table border="1"> <tr> <td colspan="3">DD-MM-YY^④</td> </tr> <tr> <td colspan="3">Factory Firmware /Logiciel usine</td> </tr> <tr> <td>L0232</td> <td>V3302</td> <td>E17D</td> </tr> <tr> <td>L0264</td> <td>V3200</td> <td>FD87E7D</td> </tr> <tr> <td>L0285^①</td> <td>V3200^②</td> <td>8C9D^③</td> </tr> </table> <p>(Example)</p>	DD-MM-YY ^④			Factory Firmware /Logiciel usine			L0232	V3302	E17D	L0264	V3200	FD87E7D	L0285 ^①	V3200 ^②	8C9D ^③	<p>This label provides information regarding firmware installed in the product.</p> <table border="1"> <tr> <td>1</td> <td>Firmware name</td> <td>3</td> <td>Firmware checksum</td> </tr> <tr> <td>2</td> <td>Firmware version</td> <td>4</td> <td>Publication date</td> </tr> </table>	1	Firmware name	3	Firmware checksum	2	Firmware version	4	Publication date
DD-MM-YY ^④																									
Factory Firmware /Logiciel usine																									
L0232	V3302	E17D																							
L0264	V3200	FD87E7D																							
L0285 ^①	V3200 ^②	8C9D ^③																							
1	Firmware name	3	Firmware checksum																						
2	Firmware version	4	Publication date																						
3	<table border="1"> <tr> <td>PRODUIT PERSONNALISE CUSTOMIZED PRODUCT</td> </tr> </table>	PRODUIT PERSONNALISE CUSTOMIZED PRODUCT	This label indicates that the product has been customized at the customer's request.																						
PRODUIT PERSONNALISE CUSTOMIZED PRODUCT																									
4		This label indicates that the product is subject to regulations for the treatment of electrical and electronic equipment waste (refer to the EC declaration of conformity for the product).																							
5	<table border="1"> <tr> <td>HLD1302577 - RS232</td> </tr> <tr> <td>Bluetooth MAC address XXXXXX / None</td> </tr> <tr> <td>Network MAC address xx:xx:xx:xx:xx:xx / None</td> </tr> </table> <p>(Example)</p>	HLD1302577 - RS232	Bluetooth MAC address XXXXXX / None	Network MAC address xx:xx:xx:xx:xx:xx / None	This label indicates the MAC address for the options installed in the product.																				
HLD1302577 - RS232																									
Bluetooth MAC address XXXXXX / None																									
Network MAC address xx:xx:xx:xx:xx:xx / None																									
6	-	Electronic module rating plate S/N ACxxxxxx																							
7	DO NOT OPERATE WITH UN-GROUND POWER CABLE	<p>This label indicates that some of the internal parts are electrically live and could cause electrical shock in case of contact.</p> <ul style="list-style-type: none"> Do not use the product if the main power supply cable is not earthed. 																							
8	DISCONNECT BEFORE MAINTENANCE	<p>This label indicates that some of the internal parts are electrically live and could cause electrical shock in case of contact.</p> <ul style="list-style-type: none"> Disconnect the main power supply cable (product side and customer installation side) from the product before servicing the product. 																							

Vacuum module

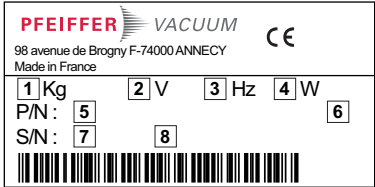
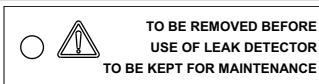
9	-	Vacuum module rating plate S/N SBxxxxxx		
10	<table border="1"> <tr> <td>warranty seal</td> </tr> <tr> <td>PFEIFFER VACUUM</td> </tr> </table>	warranty seal	PFEIFFER VACUUM	<p>This label indicates that the pump body has been sealed at the factory. Any damage to or tearing of the label shall void the warranty.</p> <ul style="list-style-type: none"> Do not open the product during the warranty period. If applications require service intervals shorter than the warranty period, contact customer service.
warranty seal				
PFEIFFER VACUUM				
11	-	Analyzer cell rating plate S/N SBxxxxxx		
12		This label indicates the grounding point on the product.		

13		<p>Product rating plate. S/N HLDxxxxxx</p> <p>This rating plate can be consulted on the detection module (2 labels: 1 on the connection port side and 1 on the module frame).</p>
14		<p>This label indicates that the blanking plate fitted on the manual valve must be removed before using the leak detector. Keep for maintenance or storage</p>
15		<p>This label indicates that the product has been certified compliant with quality control upon leaving the factory.</p>

1	Weight	5	Part Number
2	Use voltage	6	Designation
3	Use frequency	7	Serial number
4	Maximum power consumption	8	Date of manufacture

1.3.4 Abbreviations

- I/O Input/Output
- ⁴He Helium 4
- ³He Helium 3
- H₂ Hydrogen
- [XXXXXX] Control panel menus and settings
e.g. **[Measure] [Tracer Gas]** to select the tracer gas used for the test.

2 Safety

2.1 General safety information

The following 4 risk levels and 1 information level are taken into account in this document.

DANGER

Immediately pending danger

Indicates an immediately pending danger that will result in death or serious injury if not observed.

- ▶ Instructions to avoid the danger situation

WARNING

Potential pending danger

Indicates a pending danger that could result in death or serious injury if not observed.

- ▶ Instructions to avoid the danger situation

CAUTION

Potential pending danger

Indicates a pending danger that could result in minor injuries if not observed.

- ▶ Instructions to avoid the danger situation

NOTICE

Danger of damage to property

Is used to highlight actions that are not associated with personal injury.

- ▶ Instructions to avoid damage to property



Notes, tips or examples indicate important information about the product or about this document.

2.1.1 Safety instructions

All safety instructions in this document are based on the results of the risk assessment carried out in accordance with Low-Voltage Directive 2014/35/EU regarding electrical safety. Where applicable, all life cycle phases of the product were taken into account.

WARNING

Risk of electric shock due to non-compliant electrical installations

This product uses mains voltage for its electrical supply. Non-compliant electrical installations or installations not done to professional standards may endanger the user's life.

- ▶ Only qualified technicians trained in the relevant electrical safety and EMC regulations are authorized to work on the electrical installation.
- ▶ This product must not be modified or converted arbitrarily.

WARNING

Danger from magnetic fields

The product has a magnetic field that disturbs or impairs the function of electronic devices (e.g. pacemakers).

- ▶ Maintain the distances specified by the manufacturer of the pacemakers.
 - Pfeiffer Vacuum recommends a safety distance of **at least 130 mm** between the pacemaker and the product.
- ▶ Avoid the influence of strong magnetic fields by means of magnetic field shielding.

⚠ WARNING

Electric shock hazard

Voltage and current can cause electric shock.

Only skilled, authorized people may carry out maintenance work.

- ▶ Insulate and lock the power supply circuit by setting the switch to **O**.
- ▶ Disconnect the power supply cable from all power sources before working on the product and/or removing the covers.

⚠ WARNING

Risk of electric shock in case of contact with products that are not electrically isolated

When powering off _mains switch to **O_**, certain components located between the mains connection and the switch will still contain an electric charge (live). There is a risk of electric shock in case of contact.

- ▶ Make sure that the mains connection is always visible and accessible so that it can be unplugged at any time.
- ▶ Disconnect the mains cable from the electrical network before working on the product.
- ▶ Wait 5 minutes after power-off before working on the product and/or removing the cover(s).

⚠ WARNING

Health risk related to residual traces on the parts tested

A leak detection operation must be carried out under environmental conditions that do not present any risks to the operator and the equipment. The user and/or integrator of the product are fully responsible for the operational safety conditions of the equipment.

- ▶ Do not test parts or equipment with traces of harsh, chemical, corrosive, inflammable, reactive, toxic, or explosive substances, nor condensable vapors, even in small amounts.
- ▶ Apply the relevant safety instructions in accordance with local regulations.

⚠ WARNING

Risk of serious injury due to falling objects

When transporting parts/components and during product maintenance, there is a danger of injury caused by loads slipping or falling.

- ▶ Carry small and medium-size components with both hands.
- ▶ Transport components that weigh more than 20 kg using suitable lifting gear.
- ▶ Wear safety shoes with steel toes in accordance with directive EN 347.

⚠ WARNING

Risk of burns in case of contact with hot surfaces

For the operator's safety, the products are designed to avoid thermal risk. However, specific operating conditions may exist that require extra caution on the part of the operator due to the high temperatures (surfaces > 70 °C for parts inside the cover(s)).

- ▶ Wait for the product to fully cool down before working on it.
- ▶ Protective gloves must be worn in accordance with standard EN ISO 21420.

⚠ WARNING

Risk of injury from contact with pressurized neutral gas

The product uses a pressurized inert gas (e.g. nitrogen) as the purge gas. Installations that do not comply with or are not configured according to professional standards can endanger the user's life.

- ▶ Install a manual valve on the circuit at a distance of 3 m from the product, so that the neutral gas supply can be locked out.
- ▶ Observe the recommended supply pressure.
- ▶ Always lock out and disconnect the neutral gas circuit before working on the product.
- ▶ Regularly check the condition of the pipework and supply circuit connections.

2.1.2 Precautions



Duty to provide information on potential dangers

The product holder or user is obliged to make all operating personnel aware of dangers posed by this product.

Every person who is involved in the installation, operation or maintenance of the product must read, understand and adhere to the safety-related parts of this document.



Obligation to provide personal protective equipment

The operators or employers are obliged to provide the user of the product with the necessary personal protective equipment (PPE).

Persons responsible for installing, operating and repairing the product must wear PPE for safety.



Infringement of conformity due to modifications to the product

The Declaration of Conformity from the manufacturer is no longer valid if the operator changes the original product or installs additional equipment.

- Following the installation into a system, the operator is required to check and re-evaluate the conformity of the overall system in the context of the relevant European Directives, before commissioning that system.



Installation and use of the accessories

The products can be fitted with special accessories.

The installation, use and refurbishment of the connected accessories are described in detail in the respective operating instructions.

- Only use original accessories.
- Accessory part numbers (see chapter "Accessories").

Only qualified personnel trained in safety regulations (EMC, electrical safety, chemical pollution) are authorized to carry out the installation and maintenance described in this manual. Our service centers can provide the necessary training.

- ▶ Do not remove the blanked-off flange from the inlet port while the product is not in use.
- ▶ Do not expose any part of the human body to the vacuum.
- ▶ Follow the safety and accident prevention requirements.
- ▶ Regularly check compliance with all precautionary measurements.
- ▶ Do not turn on the product if the cover is not in place.
- ▶ Do not move the product while it is in use (product powered on).

2.2 Intended use

The leak detector is designed to detect and/or quantify a possible installation or component leak by searching for the presence of a tracer gas in the pumped gases.

Only the tracer gases identified in this manual may be used.

The product may be used in an industrial environment.

2.3 Foreseeable misuse

Misuse of the product will render the warranty and any claims void. Any use, whether intended or not, that diverges from the uses already mentioned will be treated as non-compliant; this includes but is not limited to:

- use of a tracer gas with a hydrogen concentration greater than 5%,
- testing parts that are soiled or that have traces of water, vapors, paint, adhesive, detergent or rinsing products,
- pumping of liquids,
- pumping of dust or solids,
- pumping of corrosive, explosive, aggressive or flammable fluids,

- pumping of reactive, chemical or toxic fluids,
- pumping of condensable vapors,
- operation in potentially explosive areas,
- product movement as soon as the product is power on,
- use of accessories or spare parts, which are not named in this manual,
- use of accessories or spare parts, which are not sold by the manufacturer.

The product is not designed to carry people or loads and is not for use as a seat, stepladder or any other similar purpose.

3 Transportation and Storage

3.1 Receipt of the product



Condition of the delivery

- Check that the product has not been damaged during transport.
- If the product is damaged, take the necessary measures with the carrier **and** notify the manufacturer.

- ▶ Keep the product in its original packaging so it stays as clean as it was when dispatched by us: only unpack the product once it has arrived at the location where it will be used.
- ▶ Keeping the blanking plates on the various inlet ports when the product is not in use.



Keep the packaging (recyclable materials) in case the product needs to be transported or stored.

3.2 Handling

NOTICE

Damage to the equipment if a detector is handled while switched on

If it is necessary to move or work on the product, the user must first make sure that the detector is fully shut down, otherwise there is a risk of damage to some of the detector components. When the main switch is set to **O**:

- ▶ Disconnect the mains cable at both ends.
- ▶ Wait 5 minutes after power-off before working on the product and/or removing the cover(s).

3.3 Storage



Pfeiffer Vacuum recommends storing the products in their original transport packaging.

- ▶ Store the electronic module, the vacuum module and the industrial control panel in their original packaging (with the detection module's turbomolecular pump in a vertical position).
- ▶ Do not store the product with a desiccant in its packaging.

Manual storage valve

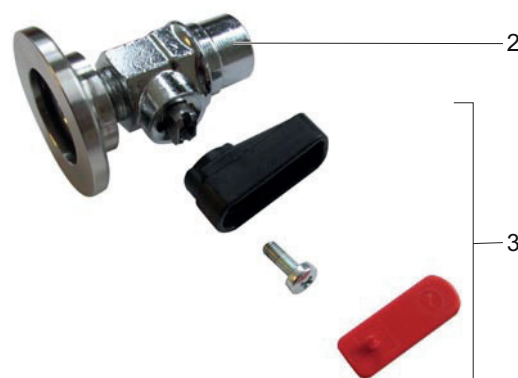
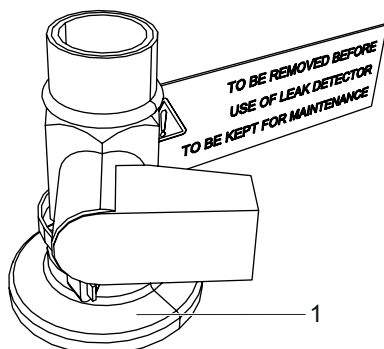

- 1 Blanking plate equipped with a manual valve (1/8" female connection) and the lever
- 2 Blanking plate with a manual valve.

- 3 Lever kit

The vacuum module is supplied with a blanking plate fitted with a manual valve on one of the two Gross Leak inlet ports. This valve is used to place the product under vacuum for storage, to protect it from any pollution and thus ensure its performance is optimal.

The lever of the manual valve must be removed to transport the detector: the lever kit is supplied with the detector. It is not necessary to refit the lever to remove the blanking plate.

1. Remove the blanking plate with manual valve before using the detector, whatever the installation configuration of the detector in the customer's equipment may be.
2. Keep the blanking plate with manual valve in order to re-use it subsequently when transporting the detector or storing it for an extended period.

New product storage

- ▶ Leave the product in its original packaging.
- ▶ Leave the blanking plate in place on each port.
- ▶ Store the module in a clean and dry environment according to the permitted temperature conditions (see chapter "Technical data").
- ▶ Beyond 3 months, factors such as temperature, humidity, salt in the air, etc. could damage some components (elastomers, lubricants, etc.). If this happens, contact your service center.

Extended periods of storage after use

2 procedures must be put in place before any prolonged shutdown and/or disassembly of the detector:

- Keep the detector in the customer's system
- Disassemble the detector from the customer's system

The vacuum module remains under a vacuum, reducing the degassing time spent when it is switched on again.

Keep the detector in the customer's system

1. Perform a test.
2. Power off the leak detector.
3. Disconnect the mains cable at both ends.
4. Wait 5 minutes after power-off before working on the product and/or removing the cover.

Disassemble the detector from the customer's system

1. Power off the leak detector.
2. Disconnect the mains cable at both ends.
3. Wait 5 minutes after power-off before working on the product and/or removing the cover.
4. Disconnect the vacuum module from the installation.
5. Place a blanking plate on each High Sensitivity and Normal inlet port.
6. Place a standard blanking plate on one of the two Gross Leak ports.
7. Check that the lever is fitted on the blanking plate/storage valve assembly (fit it if it has been removed) and that the valve is open.
8. Put the blanking plate fitted with a manual valve on the 2nd Gross Leak port.
9. Connect a pumping system (or a primary pump) to the blanking plate fitted with a manual valve and create a vacuum inside the vacuum module.
10. Close the manual valve and remove the lever to prevent any accidentally inlet vent (keep the lever for subsequent use).
11. Disconnect the pumping unit from the blanking plate fitted with a manual valve.
12. Store the vacuum module in its original packaging.

4 Product description

4.1 Product identification

To correctly identify the product when communicating with our service center, always have the information from the product rating plate available (see chapter "Labels").

4.2 Scope of delivery

- 1 leak detector (1 vacuum module + 1 electronic module)
- 1 mains power cable for Europe (France/Germany) and 1 mains power cable for the US
- 1 set of documentation (USB stick and operating instructions)
- One ½ rack plate for the electronic module
- 4 fixing brackets for the electronic module
- 1 lever for the manual storage valve
- 1 industrial control panel with its cable (according to the selected option)
- 1 cable to connect the electronic module and the vacuum module (15-pin D-Sub connector - length according to the selected option)
- 1 cable to connect the electronic module and the vacuum module (25-pin D-Sub connector - length according to the selected option)
- 1 connector (15-pin male Sub-D or 37-pin male Sub-D depending on the option chosen)
- 1 adaptor for using the Smart sniffer probe (if 'Sniffer' option selected)
- 1 special screw for the SplitFlow 50 turbomolecular pump (see the maintenance instructions for the detector)

4.3 Product overview



1. Vacuum module
 2. A ½ rack 19" 3U-compatible electronic module
 3. A ½ rack 19" 3U-compatible industrial control panel (option/accessory)
- The vacuum module and the electronic module are connected by 2 cables, length: 1.5 m, 3.5 m, 5 m or 10 m depending on the selected option.
 - The electronic module and the industrial control panel (option/accessory) are connected by a cable, length 1.8 m, 5 m or 10 m depending on the selected option.

4.3.1 Vacuum module

Description: see chapter "Connection interface" (item C)

The detection module does not include backing pumping (order separately).

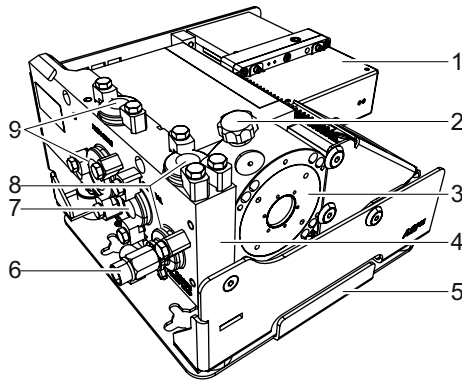

Item	Designation
1	Analyzer cell
2	Turbomolecular pump decompression knob (for maintenance use only)
3	SplitFlow 50 secondary detection pump
4	Vacuum block
5	Fixing bracket
6	Blanking plate fitted with a manual valve for storage
7	Normal mode detector inlet port: 1 x DN 16 ISO-KF
8	Gross Leak mode detector inlet port: 2 x DN 16 ISO-KF
9	High Sensitivity mode detector inlet port: 1 x DN 16 SO-KF and 1 x DN 25 ISO-KF

4.3.2 Electronic module

Description: see chapter "Connection interface" (item B)

- Fixing brackets on the electronics module enable it to be fastened (see chapter "Attachment of the electronics module").
- A plate is supplied with the detector so that the unit can be front mounted in a 19" ½ rack bay (see chapter "Attachment of the electronic module").

4.3.3 Industrial control panel (option/accessory)

Description: see chapter "Connection interface" (item A)

4.4 Connection interface

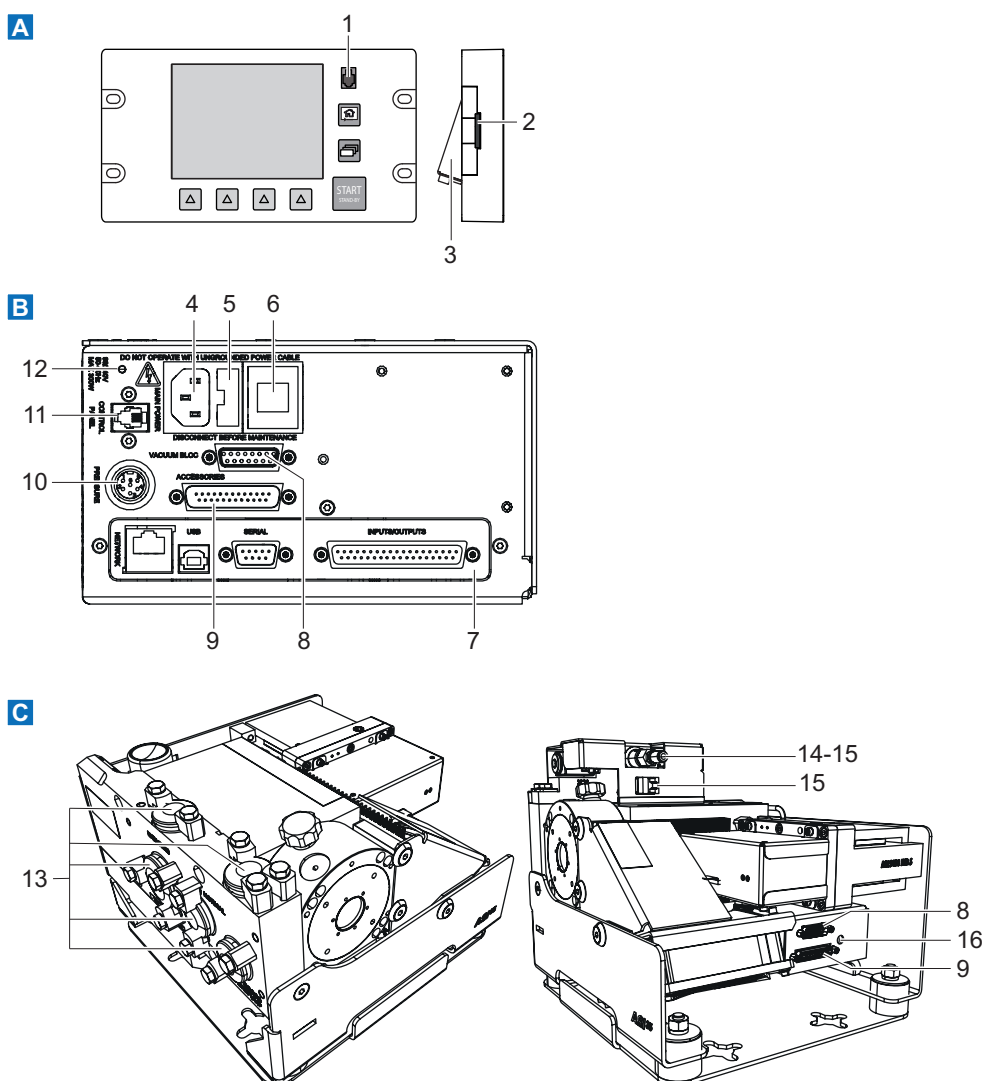

A - Industrial control panel ¹⁾

1	Standard remote control connector ²⁾
2	SD card
3	Buzzer connector ²⁾

1) Option/accessory (order separately)

2) Accessory (order separately)

B - Electronic module

4	Power supply (MAIN POWER)
5	Fuses
6	Mains switch
7	Communication interface according to order configuration (example)
8	15-pin Sub-D connector for electronic module/vacuum module cable (VACUUM BLOCK)
9	25-pin Sub-D connector for electronic module/vacuum module cable (ACCESSORIES)
10	Pressure gauge connector (PRESSURE)
11	Industrial control panel connector (see detector maintenance instructions) (CONTROL PANEL)
12	Detector ON indicator LED
13	Detector inlet port (inlet) (see chapter "Product overview")

C - Vacuum module	
8	15-pin Sub-D connector for electronic module/vacuum module cable (VACUUM BLOCK)
9	25-pin Sub-D connector for electronic module/vacuum module cable (ACCESSORIES)
14	Standard sniffer probe connector ²⁾
15	Smart sniffer probe connector ²⁾
16	24 V presence indicator LED
2) Accessory (order separately)	

4.5 Test methods

The test method is chosen depending on the part to be tested. For more information about leak detection test methods, see **Leak detector compendium** on the www.pfeiffer-vacuum.com website.

4.5.1 Hard vacuum test

- Part that can be connected to pipe and placed under a vacuum
- Part that can be placed in a vacuum chamber

Spray method

This method involves removing the air from the part to be tested, connecting it to the detector's analyzer cell, then spraying tracer gas on the points of the part that are likely to leak.

The detector measures the flow of tracer gas that penetrates due to part leakage.

When spraying starts, the leak rate is not displayed instantaneously: there is a response time which depends on the volume V being tested and the tracer gas pumping speed S of the system at the inlet of the part, according to the following relation:

- $T = V/S$ (where T = seconds, V = liters, S = l/s).
- T is the time required for the leak rate to reach 63% of the final value.

Bombing method

The part is placed ahead of time in a pressurized gas tracer chamber. The tracer gas penetrates the part through the potential leaks.

Then the part is removed from the chamber and placed in another vacuum chamber and connected to the detector.

The detector measures the flow of tracer gas that leaks out of the part.

4.5.2 Sniffer test

- Part that can be connected to pipe and cannot be placed under a vacuum.

The part to be tested is pressurized with tracer gas.

The detector measures the flow of tracer gas that leaks out of the part through a sniffer probe that moves across all the points prone to leaking.

The detector measures the flow of tracer gas that leaks out of the part.

The measured leak rate is not an exact measurement of the leak. The sniffer probe only detects part of the tracer gas escaping from the part, depending on the distance separating the crack from the tip of the probe, and the direction of the leak in relation to the probe.

4.6 Control panel description

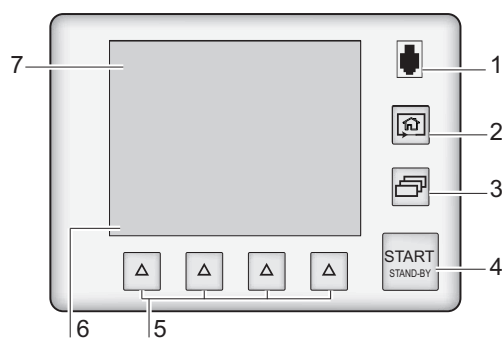

1	Standard remote control connection (accessory).
2	Changing the application screens: return to the home page ("standard" screen) from any menu.
3	Changing the level of function keys.
4	START/STAND-BY button Test Start/Stop.
5	Quick access to functions (see chapter "Function keys").
6	Displaying a function key level: starting the function or displaying a sub-menu by touching the screen.
7	Application screens (touch screen): these are accessible or hidden.

5 Installation

5.1 Securing the modules

Dimensions of the 3 modules: see chapter "Dimensions"

The drawings for each module are available on the operating instructions USB.

⚠ WARNING

Risk linked to integration into the customer's system

The product is a fuse detector which can be integrated into the equipment.

- ▶ It should not be used alone on a workbench, for example.
- ▶ It must be integrated into a system.
- ▶ The integrator or the user must ensure that the protection index of the system incorporating the leak detector is at least IP4x.

5.1.1 Attaching the vacuum module

The detection module does not include backing pumping (order separately).

Primary pump characteristics: see chapter "Primary pump characteristics"

⚠ WARNING

Risk linked to integration into the customer's system

The vacuum module can operate in any position.

The vacuum module is attached at the brackets (4 crosses).

- ▶ Do not use the leak detector without first rigidly attaching the vacuum module.
- ▶ Ensure that the vacuum module attachment can absorb a braking torque of 620 N.m

- To make integration easier, the vacuum module can be mounted in any position.
- Ensure there is sufficient room around the vacuum module to enable the module to be dismantled for maintenance.
- For maintenance needs, it is sometimes necessary to swing aside the top part of the vacuum module in order to have access to the components (see the maintenance instructions for the detector).
 - Never leave the vacuum module in this position after any maintenance work.
 - The top part of the vacuum module must always be folded down when using the detector.

Effective integration volume

The effective integration volume with the 'Sniffer' option/ accessory is larger: see the chapter "Dimensions" in the "Sniffer kit" option/accessory operating instructions.

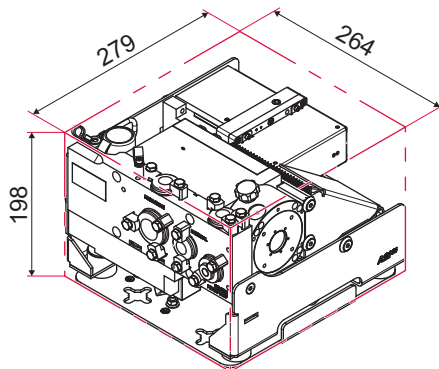

Effective integration volume (mm)

NOTICE**Risk of product components overheating**

In cases of poor ventilation, there is a risk of the detector's internal components deteriorating due to overheating.

- ▶ Comply with the permitted ambient operating temperature.
- ▶ Leave a free space of 10 cm around the vacuum module.

Fixing bracket

The drawing of the vacuum module attachment bracket is available on the operating manual USB.

Mounting with M8 CHc screws and \varnothing 8 mm washers

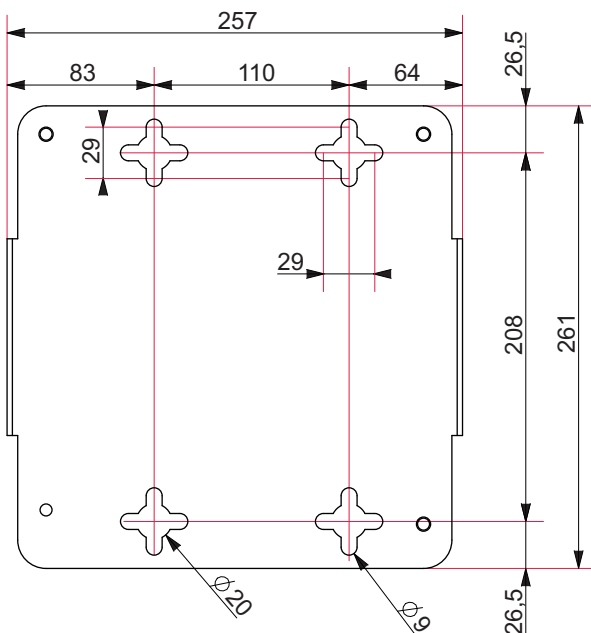

Bracket viewed from above (mm)

5.1.2 Attaching the electronic module

- The switch acts as an emergency stop: ensure access to the switch is kept free.
- To make integration easier, the electronic module can be mounted in any position.
- Leave at least 2 cm under the fan to allow the air to circulate.
- The electronic module drawings are available on the operating instructions USB.
- Ensure there is sufficient room around the electronic module to allow the module to be dismantled for maintenance.
- For maintenance needs, it is sometimes necessary to open the electronic module in order to have access to the components (see the Maintenance instructions for the detector).
 - Never leave the module open after any maintenance work.
 - The electronic module must always be closed down when using the detector.

Fixing brackets

4 fixing brackets with screws are supplied with the leak detector: they are fixed on the different corners of the module, or instead of the feet, to attach the electronic module to a wall or other support.

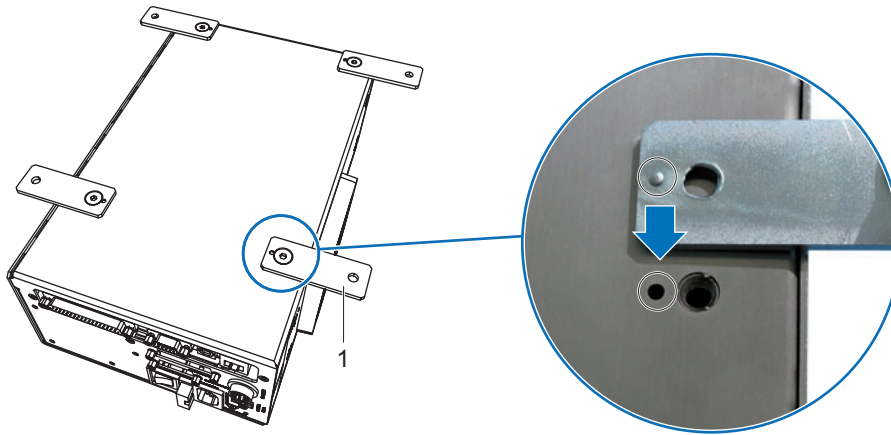

1 Fixing bracket

1/2 rack module fastening plate

- A plate for mounting the electronic module in a 1/2 rack space is supplied with the detector (the plate drawing is available on the operating instructions USB).

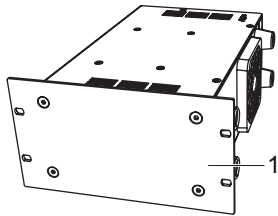

1 1/2 rack plate

Precautions to take when you fix the control panel and electronic module in a 1 rack format.

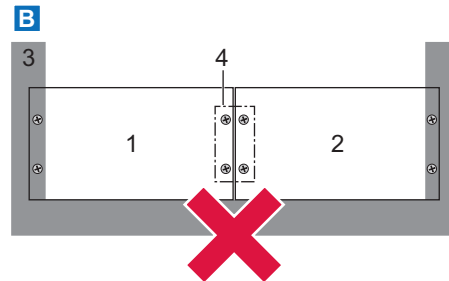
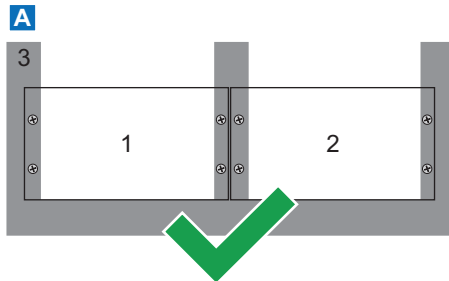

A The electronic module and industrial control panel must be attached separately on the customer's system.

B Electronic module and industrial control panel must never be fixed together on the customer's system.

- 1 Electronic module (1/2 rack)
- 2 Industrial control panel (1/2 rack)

- 3 Customer's system
- 4 Plate fixing together electronic module and industrial control panel

1 rack module fastening plate

The drawing of another plate, allowing the electronic module to be mounted in a 1 rack format, is available on the operating instructions USB (plate at the customer's expense).

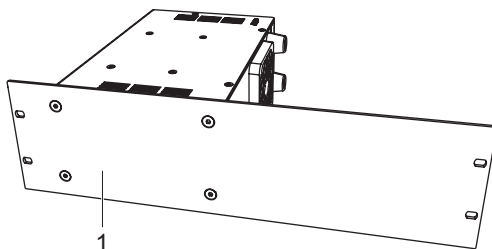

1 1 rack plate

Attaching the feet to the module

4 rubber feet are screwed onto the electronic module. They allow the module to be positioned on a table. It is possible to screw these 4 feet on the other sides of the module.

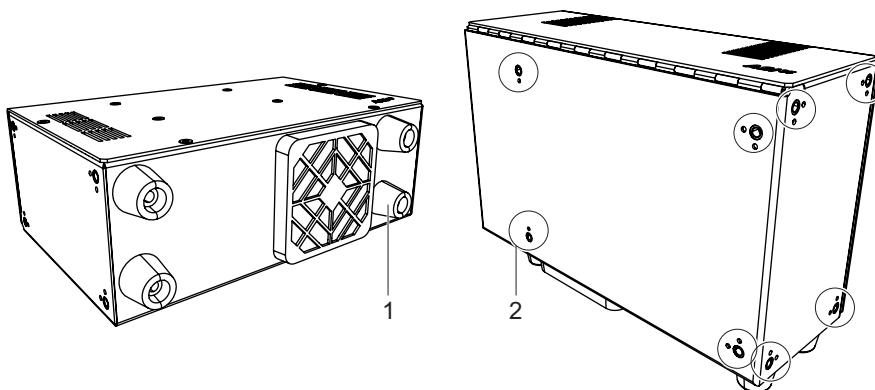

1 Rubber feet (x4)

2 Feet mounting point

Ventilation

NOTICE

Risk of product components overheating

In cases of poor ventilation, there is a risk of the detector's internal components deteriorating due to overheating.

- ▶ Comply with the permitted ambient operating temperature.
- ▶ Leave a free space of 10 cm around the vacuum module.

The electronic module is fitted with an internal fan connected to a protection filter on the outside. Air vents are also provided to ventilate the electronic module.

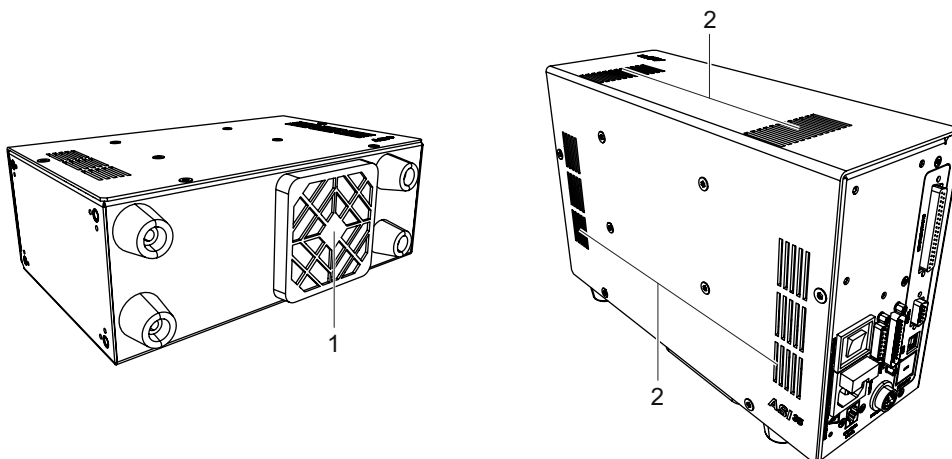

1 Internal fan connected to a protection filter

2 Air vent

5.1.3 Attaching the industrial control panel

The industrial control panel with ½ rack format is available as an option or accessory. The industrial control panel drawings are available on the operating instructions USB.

SD card

Control panel is delivered with an SD card.

- ▶ To remove/insert the SD card, use a thin non-metallic object.

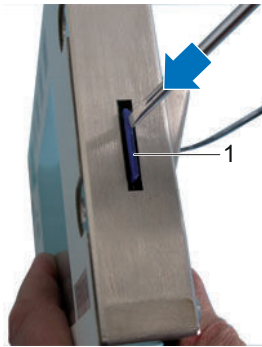

1 SD card

½ rack module fastening plate

The drawing of a plate used to mount the industrial control panel in a 1 rack format is available in the operating instructions USB (manufacture of this plate is at the customer's expense).

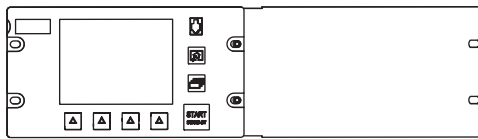

Precautions to take when you fix the control panel and electronic module in a 1 rack format.

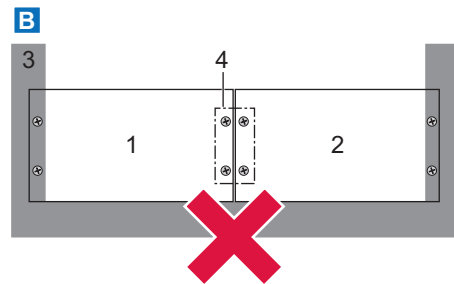
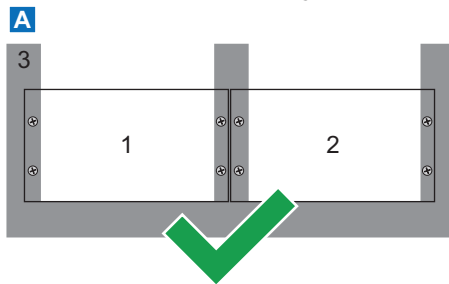

A The electronic module and industrial control panel must be attached separately on the customer's system.

B Electronic module and industrial control panel must never be fixed together on the customer's system.

- 1 Electronic module (½ rack)
- 2 Industrial control panel (½ rack)

- 3 Customer's system
- 4 Plate fixing together electronic module and industrial control panel

Buzzer

Buzzer characteristics: 80 mA (max) / 24 V

The leak detector is not equipped with loudspeaker. However, it is possible to connect a buzzer to the control panel:

- The wiring harness that connects the buzzer to the control panel is supplied with panel.
- The buzzer is not delivered with the control panel. It is at the customer's expense.

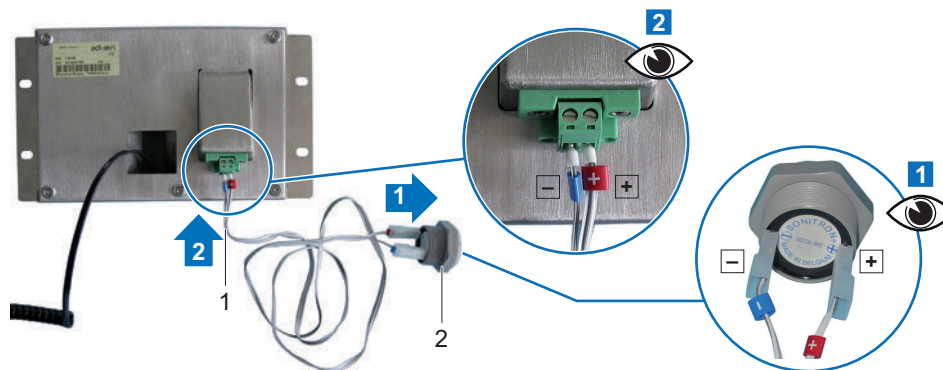

 **Observe +/- polarities when connecting the control panel wiring harness to the buzzer.**

1 Harness 2 Buzzer

- ▶ To stop the buzzer without disconnecting it, select the “Mute” function using a function key (see chapter “Function keys”).

5.2 Connecting the installation to be tested

NOTICE

Risk of deterioration of parts or installations

There is a risk of deterioration for parts or installations connected to the leak detector vacuum circuit.

- ▶ Make sure that the parts or installations connected to the detector’s pump inlet withstand a negative pressure of $1 \cdot 10^3$ hPa in relation to the atmospheric pressure.

5.2.1 Prerequisites for optimizing measurement

To optimize pumping and measurement speed

- ▶ Use pipes with a diameter equal to the diameter of the detector’s inlet. The pipes should be as short as possible and completely sealed.
- ▶ Connect the part or the installation to be tested using the flexible pipeworks. Never use rigid or flexible plastic pipework (compressed air style tube).
- ▶ Check that the connected part/installation is impervious to tracer gas.
- ▶ Test only clean, dry parts/installations with no trace of water, vapor, paint, detergent or rinsing products.
- ▶ Test that the entire line is completely sealed when the detector is attached to the pumping circuit, to ensure that the connections are correct (pump, pipes, solenoid valves, etc.).

5.2.2 Installation instructions to be observed

NOTICE

Risk of deterioration of parts or installations

There is a risk of deterioration for parts or installations connected to the leak detector vacuum circuit.

- ▶ Make sure that the parts or installations connected to the detector’s pump inlet withstand a negative pressure of $1 \cdot 10^3$ hPa in relation to the atmospheric pressure.

NOTICE

Risk of pollution from solid substances

When applications generate particles, we recommend protecting the detector inlet.

- ▶ Install an inlet filter (see chapter “Accessories”).

⚠ WARNING

Risk of injury due to the use of hydrogen as tracer gas

Hydrogen can be used as a tracer gas for leak detection. Depending on its concentration, in the worst scenario, there may be a risk of explosion.

- ▶ Never use a tracer gas with a hydrogen content greater than 5%.
- ▶ Use hydrogenated nitrogen as a tracer gas: mix of 95% N₂ and 5% H₂.

- ▶ Comply with the recommendations (see chapter “Pre-requisites for optimizing measurement”).
- ▶ Respect the environmental conditions (see chapter “Technical characteristics”).
- ▶ When assembling the vacuum circuit, use accessories to shut off the product and make maintenance easier (inlet shut off valves, purge systems, etc.).
- ▶ Connect the part or the equipment using the connection accessories available in the product catalogue.
- ▶ Remove the blanking plates on the various inlet ports and keep them for re-use for storage or transport.
- ▶ The detector’s performance depends on the type of accessories used and on the quality of the mechanical connections.
- ▶ Remove the blanking plate/storage valve assembly located on the Gross Leak inlet port, whatever connection port is used for the installation (see chapter “Storage”).
- ▶ Backing pumping (order separately) shall always be connected to one of the two Gross Leak mode inlet ports.
- ▶ Never connect the part for testing to several of the detection module’s inlet ports.
- ▶ The pressure inside the product must never exceed 100 kPa (absolute).
- ▶ Whatever the configuration of the customer’s installation, the pressure at the detector exhaust must never exceed 18 hPa.
- ▶ Never exceed a load weight of 10 kg on an inlet port.

5.2.3 Vacuum circuit of the vacuum module

The customer’s system will be connected to the vacuum module on one or more inlet ports.

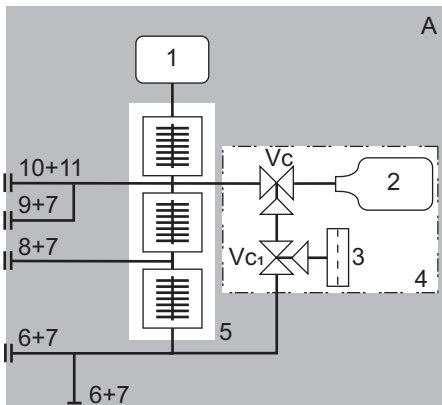

Vacuum circuit of the ASI 35 vacuum module

Item	Designation
1	Analyzer cell
2	Internal calibrated leak ¹⁾
3	Dust filter ¹⁾
4	'Internal calibration' kit ¹⁾
5	SplitFlow 50 turbomolecular pump
6	2 x DN 16 ISO-KF gross leak mode inlet port
7	Blanking plate, DN 16 ISO-KF
8	Normal mode inlet port - 1 x DN 16 ISO-KF
9	High sensitivity mode inlet port - 1 x DN 16 ISO-KF

1) 'Internal calibration' option/accessory

Item	Designation
10	High sensitivity mode inlet port - 1 x DN 25 ISO-KF
11	Blanking plate, DN 25 ISO-KF
V _c	Calibration valve ¹⁾
V _{ct}	Roughing valve of the internal calibrated leak ¹⁾
A	ASI 35 vacuum module

1) 'Internal calibration' option/accessory

5.2.4 Connection of the primary pump

Characteristics

Primary pump	Wet or Dry pump
Connection	DN 16 ISO-KF Hose with a maximum length of 2 m between the detector and the primary pump
Ultimate vacuum	< 1 hPa (5·10 ⁻² hPa recommended)
Min flow	1 m ³ /h If using in sniffer with the Smart probe, minimum flow rate = 3 m ³ /h
Max flow	100 m ³ /h A higher flow rate will not improve the performance of the leak detector + primary pump assembly.

Connection

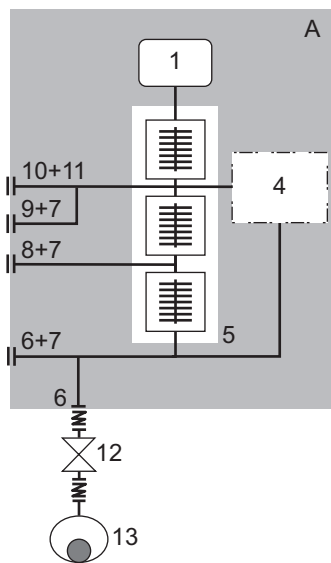

Item	Designation
1	Analyzer cell
4	'Internal calibration' kit ¹⁾
5	SplitFlow 50 turbomolecular pump
6	DN 16 ISO-KF Gross Leak mode inlet port
7	Blanking plate, DN 16 ISO-KF
8	DN 16 ISO-KF Normal mode inlet port
9	DN 16 ISO-KF High Sensitivity mode inlet port
10	DN 25 ISO-KF High Sensitivity mode inlet port
11	Blanking plate, DN 25 ISO-KF
12	Isolation valve ²⁾

1) 'Internal calibration' option/accessory

2) At the customer's expense

Item	Designation
13	Primary pump ²⁾
A	ASI 35 vacuum module

1) 'Internal calibration' option/accessory
 2) At the customer's expense

5.2.5 Gross Leak mode port connection

Characteristics of this type of connection

- Limited sensitivity
- Very good analyzer cell protection

Connection

- ▶ See chapter "Installation instructions to be observed"
- ▶ see chapter "Technical characteristics"
- ▶ See chapter "Primary pump characteristics"

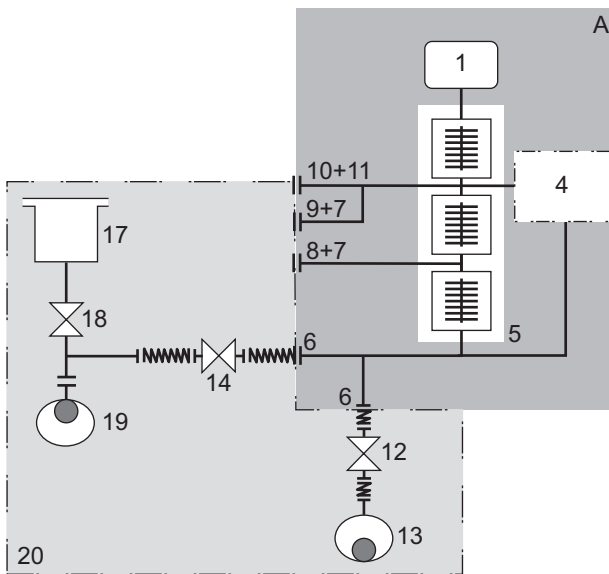

Gross Leak mode connection vacuum circuit

Item	Designation
1	Analyzer cell
4	'Internal calibration' kit ¹⁾
5	SplitFlow 50 turbomolecular pump
6	DN 16 ISO-KF Gross Leak mode inlet port
7	Blanking plate, DN 16 ISO-KF
8	DN 16 ISO-KF Normal mode inlet port
9	DN 16 ISO-KF High Sensitivity mode inlet port
10	DN 25 ISO-KF High Sensitivity mode inlet port
11	Blanking plate, DN 25 ISO-KF
12	Isolation valve ²⁾
13	Primary pump ²⁾
14	Test valve 1 (Gross Leak mode) ²⁾
17	Pumped chamber or part ²⁾
18	Roughing valve ²⁾
19	Pumping system ²⁾

1) 'Internal calibration' option/accessory
 2) At the customer's expense

Item	Designation
20	Customer's system ²⁾
A	ASI 35 vacuum module

1) 'Internal calibration' option/accessory

2) At the customer's expense

Calibration (the detector to be equipped with the 'Internal calibration' option/accessory)

- Test valve 1 is closed throughout the calibration phase.

5.2.6 Normal mode port connection

Characteristics of this type of connection

- High crossover pressure in relation to High Sensitivity mode
- Good sensitivity

Connection

- ▶ See chapter "Installation instructions to be observed"
- ▶ see chapter "Technical characteristics"
- ▶ See chapter "Primary pump characteristics"

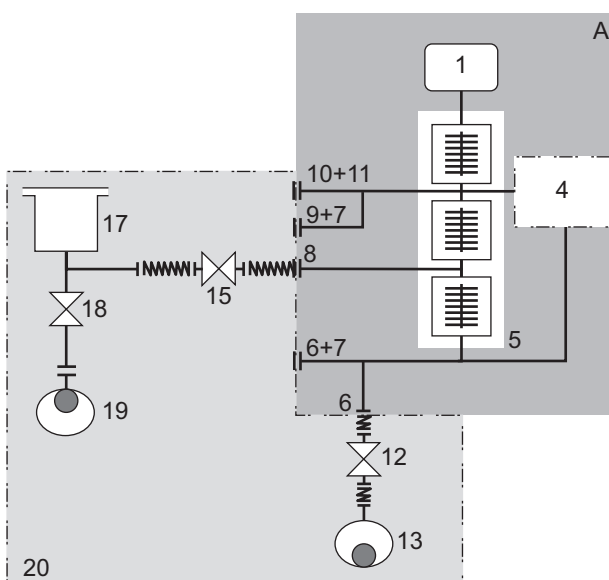

Normal mode connection vacuum circuit

Item	Designation
1	Analyzer cell
4	'Internal calibration' kit ¹⁾
5	SplitFlow 50 turbomolecular pump
6	DN 16 ISO-KF Gross Leak mode inlet port
7	Blanking plate, DN 16 ISO-KF
8	DN 16 ISO-KF Normal mode inlet port
9	DN 16 ISO-KF High Sensitivity mode inlet port
10	DN 25 ISO-KF High Sensitivity mode inlet port
11	Blanking plate, DN 25 ISO-KF
12	Isolation valve ²⁾
13	Primary pump ²⁾
15	Test valve 2 (Normal mode) ²⁾
17	Pumped chamber or part ²⁾

1) 'Internal calibration' option/accessory

2) At the customer's expense

Item	Designation
18	Roughing valve ²⁾
19	Pumping system ²⁾
20	Customer's system ²⁾
A	ASI 35 vacuum module

1) 'Internal calibration' option/accessory

2) At the customer's expense

Calibration (the detector to be equipped with the 'Internal calibration' option/accessory)

- Test valve 2 is closed throughout the calibration phase.

5.2.7 High Sensitivity mode port connection

Characteristics of this type of connection

- High tracer gas pumping speed.
- Very good sensitivity.

Connection

- ▶ See chapter "Installation instructions to be observed"
- ▶ see chapter "Technical characteristics"
- ▶ See chapter "Primary pump characteristics"

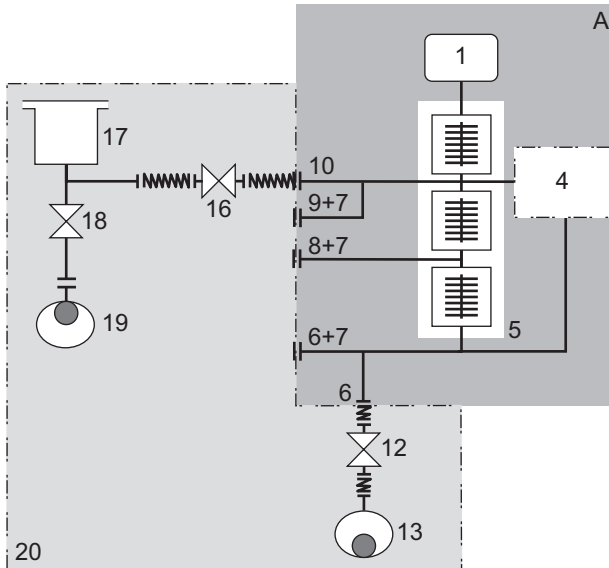

High Sensitivity mode connection vacuum circuit

Item	Designation
1	Analyzer cell
4	'Internal calibration' kit ¹⁾
5	SplitFlow 50 turbomolecular pump
6	DN 16 ISO-KF Gross Leak mode inlet port
7	Blanking plate, DN 16 ISO-KF
8	DN 16 ISO-KF Normal mode inlet port
9	DN 16 ISO-KF High Sensitivity mode inlet port
10	DN 25 ISO-KF High Sensitivity mode inlet port
11	Blanking plate, DN 25 ISO-KF
12	Isolation valve ²⁾
13	Primary pump ²⁾

1) 'Internal calibration' option/accessory

2) At the customer's expense

Item	Designation
16	Test valve 3 (High Sensitivity mode) ²⁾
17	Pumped chamber or part ²⁾
18	Roughing valve ²⁾
19	Pumping system ²⁾
20	Customer's system ²⁾
A	ASI 35 vacuum module

1) 'Internal calibration' option/accessory

2) At the customer's expense

Calibration (the detector to be equipped with the 'Internal calibration' option/accessory)

- Test valve 3 is closed throughout the calibration phase.

5.2.8 Connection on the Gross Leak, Normal and High Sensitivity mode ports

Characteristics of this type of connection

- Connecting the customer's system simultaneously on an inlet port for each test mode enables the customer to work in the 3 test modes.
- Very good sensitivity.

Connection

- ▶ See chapter "Installation instructions to be observed"
- ▶ see chapter "Technical characteristics"
- ▶ See chapter "Primary pump characteristics"

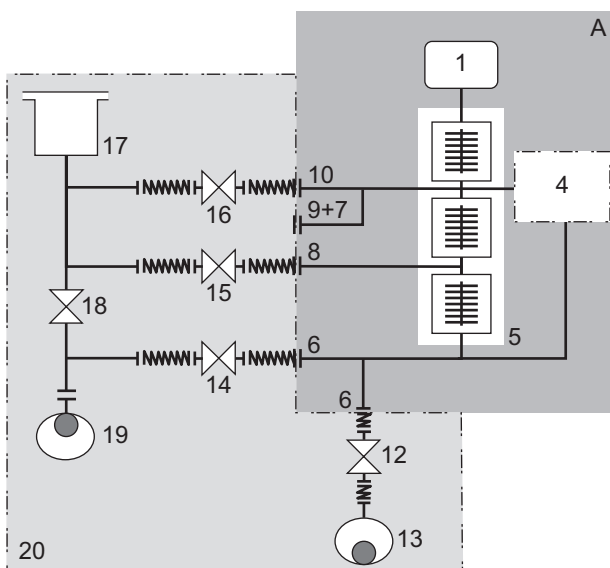

Gross Leak, Normal and High Sensitivity mode connection vacuum circuit

Item	Designation
1	Analyzer cell
4	'Internal calibration' kit ¹⁾
5	SplitFlow 50 turbomolecular pump
6	DN 16 ISO-KF Gross Leak mode inlet port
7	Blanking plate, DN 16 ISO-KF
8	DN 16 ISO-KF Normal mode inlet port
9	DN 16 ISO-KF High Sensitivity mode inlet port
10	DN 25 ISO-KF High Sensitivity mode inlet port
11	Blanking plate, DN 25 ISO-KF

1) 'Internal calibration' option/accessory

2) At the customer's expense

Item	Designation
12	Isolation valve ²⁾
13	Primary pump ²⁾
14	Test valve 1 (Gross Leak mode) ²⁾
15	Test valve 2 (Normal mode) ²⁾
16	Test valve 3 (High Sensitivity mode) ²⁾
17	Pumped chamber or part ²⁾
18	Roughing valve ²⁾
19	Pumping system ²⁾
20	Customer's system ²⁾
A	ASI 35 vacuum module

1) 'Internal calibration' option/accessory

2) At the customer's expense

Calibration (the detector to be equipped with the 'Internal calibration' option/accessory)

- Test valves 1, 2 and 3 are closed throughout the calibration phase.

5.2.9 Connection in Sniffer mode

- ▶ Consult the Operating instructions for the 'Sniffer' option/accessory.

5.3 Electrical connection

⚠ WARNING

Risk of electric shock due to non-compliant electrical installations

This product uses mains voltage for its electrical supply. Non-compliant electrical installations or installations not done to professional standards may endanger the user's life.

- ▶ Only qualified technicians trained in the relevant electrical safety and EMC regulations are authorized to work on the electrical installation.
- ▶ This product must not be modified or converted arbitrarily.

NOTICE

Risk of electromagnetic disturbance

Voltages and currents can induce a multitude of electromagnetic fields and interference signals. Installations that do not comply with the EMC regulations can interfere with other equipment and the environment in general.

- ▶ Use shielded cables and connections for the interfaces in interference-prone environments.

Electrical safety

The leak detector is Class 1 equipment and therefore must be earthed.

- ▶ Ensure that the switch is set to **O**.
- ▶ Connect the power supply to the connector using the power cable supplied with the detector (see chapter "Connection interface").
- ▶ (see chapter "Technical characteristics")

5.4 Connecting the exhaust

The detector exhaust must never be obstructed.

NOTICE

Risk of deterioration due to overpressure at exhaust

Too much pressure at the detector's exhaust risks damaging the detector.

- ▶ Ensure that the customer application exhaust line is always under slightly negative pressure.
- ▶ Make sure the detector's exhaust pressure does not exceed 200 hPa (relative).

5.5 Gauge connection (accessory)

- ▶ Get a gauge which is compatible with the detector and its connection cable.

Models of gauge to be used

- CMRxxx
- APRxxx
- TPRxxx
- PCRxxx

5.5.1 Installation

The pressure gauge can be installed in any part of the vacuum system for which a pressure indication is required.

- ▶ See chapter "Installation instructions to be observed"
- ▶ see chapter "Technical characteristics"
- ▶ See chapter "Primary pump characteristics"

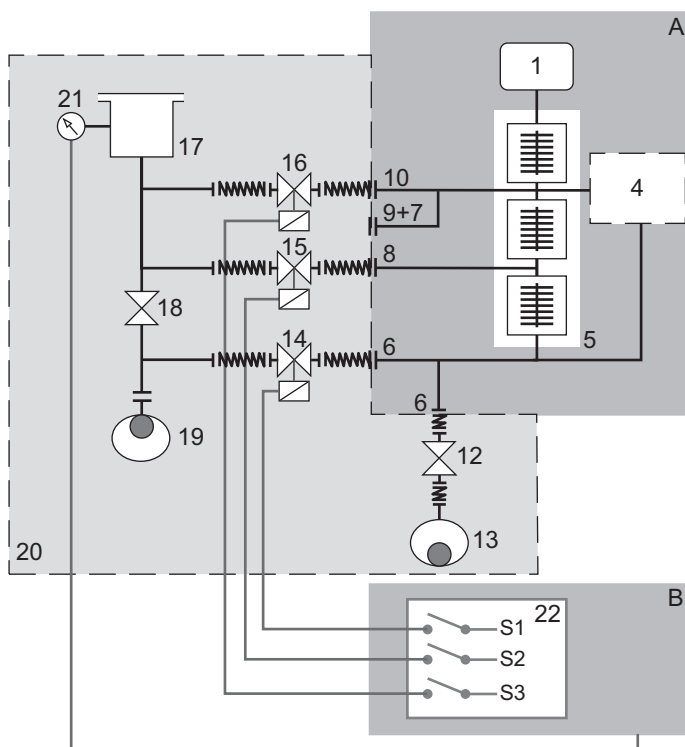

E.g. installation of the gauge and control of the test valves by the electronic module equipped with the 37-pin I/O communication interface (option/accessory).

Item	Designation
1	Analyzer cell
4	'Internal calibration' kit ¹⁾
5	SplitFlow 50 turbomolecular pump

1) 'Internal calibration' option/accessory

2) At the customer's expense

3) Option/Accessory

Item	Designation
6	DN 16 ISO-KF Gross Leak mode inlet port
7	Blanking plate, DN 16 ISO-KF
8	DN 16 ISO-KF Normal mode inlet port
9	DN 16 ISO-KF High Sensitivity mode inlet port
10	DN 25 ISO-KF High Sensitivity mode inlet port
12	Isolation valve ²⁾
13	Primary pump ²⁾
14	Test valve 1 (Gross Leak mode) ²⁾
15	Test valve 2 (Normal mode) ²⁾
16	Test valve 3 (High Sensitivity mode) ²⁾
17	Pumped chamber or part ²⁾
18	Roughing valve ²⁾
19	Pumping system ²⁾
20	Customer's system ²⁾
21	Gauge ²⁾
22	37-pin I/O communication interface ³⁾
A	ASI 35 vacuum module
B	ASI 35 electronic module

1) 'Internal calibration' option/accessory

2) At the customer's expense

3) Option/Accessory

5.5.2 Setting

Each one of the 3 adjustable thresholds allows a relay output to be switched.

These set points are defined in the Set Points menu (see chapter "Other pressure set points")

Set point 1	"Press s.pt #1" digital output - direct current (switch to Gross Leak mode)
Set point 2	"Press s.pt #2" digital output - direct current (switch to Normal mode)
Set point 3	"Press s.pt #3" digital output - direct current (switch to High Sensitivity mode)

Frequency	Test mode in progress	Max. crossover threshold in the current test mode	State of the valves in the current test mode		
			Test valve 1 (Gross Leak mode)	Test valve 2 (Normal)	Test valve 3 (High Sensitivity)
1500 Hz	Gross Leak	Set point 1 = 18 hPa (18 mbar)	Open	Closed	Closed
	Normal	Set point 2 = 1 hPa (1 mbar)	Closed	Open	Closed
	High Sensitivity	Set point 3 = 0.2 hPa (0.2 mbar)	Closed	Closed	Open
1000 Hz	Gross Leak	Set point 1 = 18 hPa (18 mbar)	Open	Closed	Closed
	Normal	Set point 2 = 3.5 hPa (3.5 mbar)	Closed	Open	Closed
	High Sensitivity	Set point 3 = 0.1 hPa (0.1 mbar)	Closed	Closed	Open

Digital outputs are active only when the leak detector is in a cycle.



In order to be able to control the test valves by the detector only, the 3 set points are never enabled at the same time.

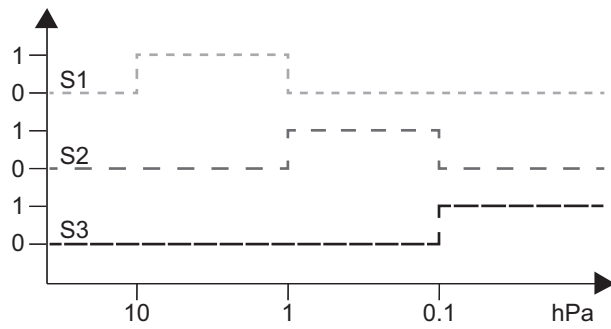

Relay activation

5.5.3 Atmospheric pressure/ Limit pressure adjustments

- ▶ Refer to instructions delivered with the gauge used.

6 Commissioning

6.1 Start-up of the detector

1. Make sure the customer's primary pump is connected to the detector and powered up.
2. Connect the power supply to the mains connector using the power cable supplied with the detector.
3. Position the mains switch to **I**.
4. First commissioning: set the language, unit, date and time.
 - The operator can change this setting later (see chapter "Time - Date - Unit - Language").
5. Wait for the detector to enter 'Stand-by' mode.

Start-up after an extended shutdown



After a shutdown of the detector of more than 3 months, it is advisable to start up the detector 24 hours before its use.

If the detector has been stored or has not been used, start-up time is longer than if it is in regular use.

6.2 Detector powering off

1. Position the mains switch to **O**.
2. Disconnect the mains power cable.
3. Wait 5 minutes before working on the detector, removing the cover, or moving the detector.

Pump stop due to power failure



When there is a mains power failure, the detector shuts down: it switches on again automatically when power is restored.

6.3 Familiarize yourself with the control panel



Industrial control panel with ½ rack format is available as option or accessory for this detector.

Control panel description (see chapter "Control panel description").

- ▶ Press  several times to familiarize yourself with the application screens.
- ▶ Press  several times to see the 2 levels of function keys available.
- ▶ At each level, press  or the control panel function key to access the function.

7 Operation

7.1 Use conditions

WARNING

Risk of injury due to the use of hydrogen as tracer gas

Hydrogen can be used as a tracer gas for leak detection. Depending on its concentration, in the worst scenario, there may be a risk of explosion.

- ▶ Never use a tracer gas with a hydrogen content greater than 5%.
- ▶ Use hydrogenated nitrogen as a tracer gas: mix of 95% N₂ and 5% H₂.

NOTICE

Leak detector ventilation

In cases of poor ventilation, there is a risk of deterioration of the detector's internal components by heating.

- ▶ Comply with the ambient operating temperature.
- ▶ Do not obstruct the ventilation grids.
- ▶ Ventilation grids should be cleaned regularly.
- ▶ Leave a free space of at least 10 cm all around the leak detector.
- ▶ Store nothing under the detector.

NOTICE

Risk of deterioration from solid particles

The tested applications may generate solid particles.

It is recommended in this case to protect the detector inlet (inlet port).

- ▶ Install a filter at the detector inlet (see chapter "Accessories").

Environmental conditions: see chapter "Technical characteristics".

7.2 Prerequisites for optimizing use

To optimize the use of the detector:









- ▶ Test only clean, dry parts/installations with no trace of water, vapor, paint, detergent or rinsing products.
- ▶ Check that the connected part/installation is impervious to tracer gas.
- ▶ Make sure that the test area is not polluted by the tracer gas.
- ▶ No message should be displayed.
 - No  pictograph is displayed on the main screen.
 - If the pictograph is displayed, read the message and address it.
- ▶ Perform leak detector calibration.

Before each switched on:

- ▶ Become familiar with the safety instructions.
- ▶ Check that all the connections are correct.

7.3 Operation monitoring

During operation, the user is notified of an incident on the detector control panel.

Type of fault	Control panel	
Warning	Display of fault.  	Click on the pictogram  to display the fault.
Error	Display of fault.  	Click on the pictogram  to display the fault.
Critical error	Display of the message "Critical error - E244".  	Contact our service center.

7.4 Test Start/Stop

Prerequisites

See chapters "Switching the detector on" and "Test launched automatically upon start-up"

Test method

The test method is chosen depending on the part to be tested.

For more information about leak detection test methods, see **Leak detector compendium** on the www.pfeiffer-vacuum.com website.

There are 2 possible test methods:

- hard vacuum test
- Sniffer test

The sniffer test requires the 'Sniffer' option/accessory (see chapter 'Accessories').

Hard vacuum test

The test can also be started using a remote control (accessory): see the remote control operating instructions.

1. Select the 'hard vacuum' test method (see chapter "Test method").
2. Select the test mode (see chapter "Test mode").
3. Set the reject point if necessary (see chapter "Hard vacuum reject point").
4. Put the detector on 'Stand-by' mode.
 - In 'Stand-by' mode, the leak rate displayed corresponds to the detector's background.
5. Prepare the installation to be tested (see chapter "Installation connection to be tested").
 - Spray method
 - Connect the installation to be tested to the leak detector inlet port.
 - Evacuate the air from the installation to be tested.
 - Bombing method
 - Place the part to be tested in a pressurization chamber with the tracer gas.
 - Remove the part to be tested from the chamber and put it in the test chamber connected to the leak detector inlet port.
6. Begin the test by pressing the **START/STAND-BY** button.
 - Spray method
 - Spray the tracer gas on the points on the part that are likely to leak.
7. The various test steps are displayed.

When the detector has reached the most sensitive test mode, wait for the measurement to stabilize: the measurement displayed corresponds to the measured leak rate.

8. Stop the test by pressing the **START/STAND-BY** button.

Sniffer test

The sniffer test requires the 'Sniffer' option/accessory (see chapter 'Accessories').

1. Prepare the installation to be tested.
2. Select the 'sniffer' test method (see chapter "Test method").
3. Depending on the model of the detector, select the model of the sniffer probe used (see chapter "Type of probe").
4. Set the reject point if necessary (see chapter "Sniffing reject set point").
5. Put the detector on 'Stand-by' mode.
6. Connect the sniffer probe (accessory).
7. Begin the test by pressing the **START/STAND-BY** button.
8. Then run the sniffer probe slowly over the areas of the part to be tested that may leak: the leak rate displayed varies when a leak is detected (quantitative value of the measured leak rate).
9. Stop the test by pressing the **START/STAND-BY** button.

7.5 Calibration

Calibration helps ensure that the leak detector is correctly adjusted to detect the tracer gas selected and display the correct leak rate.

A calibrated leak is used to calibrate the leak detector.

The leak detector should be calibrated with a calibrated leak of the same type as the tracer gas used.



Detector calibration

20 minutes after switching it on, the detector suggests that the user perform a calibration. For correct use of the detector and to optimize the accuracy of the measurement, **this calibration must be performed.**

It is recommended to perform a calibration:

- at least once a day,
- for intense operation: start calibration at the beginning of each work session (e.g. work in shifts, every 8 hours),
- if it is uncertain whether the detector is working properly.



Tracer gas or test method setting modification

The selected test method and tracer gas have an impact on the calibration.

It is mandatory to perform a calibration of the detector if one of the following parameters is modified:

- test method (hard vacuum or sniffing)
- tracer gas (^4He , ^3He or H_2)

Internal calibrated leak

The internal calibrated leak is specifically designed for the leak detector. It is composed of:

- a reservoir filled with ^4He tracer gas (no internal calibration with other tracer gases),
- a temperature sensor (to take into account the effect of temperature on the leak rate),
- an integrated diaphragm (to calibrate the leak rate),
- an identification label (identical to the identification label of an external calibrated leak).

The calibrated leak is supplied with a calibration certificate.



Use a calibrated leak in the range of $\approx 10^{-7}$ mbar · l/s ($\approx 10^{-8}$ Pa · m³/s).



In the case of intensive use of the detector, a spare internal calibrated leak is recommended. By default, the detector can be calibrated with an external calibrated leak.

External calibrated leak

The operator must use a calibrated leak containing the tracer gas selected (^4He , ^3He or H_2).

There are several types of external calibrated leaks, with or without reservoir, with or without valve, covering several ranges of leaks.

The manufacturer does not provide calibrated leaks in ^3He and H_2 .



The choice of external calibrated leak depends on application requirements: use a calibrated leak from the same leak rate range as the leak to be measured.

7.5.1 Calibration in hard vacuum test mode with internal calibrated leak

Calibration with an internal calibrated leak requires the 'Internal calibration' option/accessory (see chapter "Accessories").

Internal calibrated leak (see chapter "Calibration").

Calibration can be performed when the detector is in test mode.

1. Allocate a function key to **[AUTOCAL]** (see chapter "Function keys").
2. Configure the following settings:
 - The mode must be identical to the port used to connect the detector (example: connection to the Normal port -> 'Normal' mode selected).
 - test method: hard vacuum (see chapter "Test method").
 - type of calibrated leak: internal (see chapter "Calibrated leak").
 - calibration: operator (see chapter "Leak Detection: Calibration").
3. Check that the detector is in 'Stand-by' mode.
4. Check the leak settings (leak rate corrected for temperature and time as needed) (see chapter "Calibrated leak").
5. Press the **[AUTOCAL]** function key to start a calibration.

7.5.2 Calibration in hard vacuum test mode with external calibrated leak

External calibrated leak (see chapter "Calibration").



Calibration with an external calibrated leak is advised when the reject point is far from the internal calibrated leak value.

1. Allocate a function key to **[AUTOCAL]** (see chapter "Function keys").
2. Configure the following settings:
 - The mode must be identical to the port used to connect the detector (example: connection to the Normal port -> 'Normal' mode selected).
 - test method: hard vacuum (see chapter "Test method").
 - type of calibrated leak: external (see chapter "Calibrated leak").
 - calibration: operator (see chapter "Leak Detection: Calibration").
3. Verify the setting for the external calibrated leak used (see chapter "Calibrated leak").
4. As needed, correct the parameters of the external calibrated leak used (see the label for the calibrated leak or the calibration certificate).
5. Select the tracer gas for the external calibrated leak (see chapter "Calibrated leak").
6. Check that the detector is in 'Stand-by' mode.
7. Place the external calibrated leak on one of the ports on the detection module.
8. Press the **[AUTOCAL]** function key to start the calibration.
9. Follow the instructions given by the leak detector.
 - Press **[Next]** to move to the next step.

At the end of the calibration, the detector returns to 'Stand-by' mode.

7.5.3 Calibration in hard vacuum test mode with machine calibration

Machine calibration requires:

- the detector to be equipped with the 'Internal calibration' option/accessory
- the customer's installation to be equipped with an external calibrated leak.
 - Do not connect the external calibrated leak to the detection module.



Machine calibration is recommended if the detector is connected to a system with its own pumping unit.



If the detector is equipped with 'Internal calibration' option/accessory, you are advised to perform a machine calibration.

If the detector is not equipped with the 'Internal calibration' option/accessory, it is advisable to perform an autocorrection (see chapter "Calibration with a pumping system in parallel").

Before performing a machine calibration, the detector should be calibrated by carrying out a calibration with the internal or external calibrated leak.

1. Isolate the leak detector by closing all valves connecting the detector to the customer's system.
2. Place the external calibrated leak on the customer's system.
3. Check the following parameters (correct if necessary):
 - The mode must be identical to the port used to connect the detector (example: connection to the Normal port -> 'Normal' mode selected).
 - test method: hard vacuum (see chapter "Test method").
 - calibration: operator (see chapter "Calibration function").
4. Set the type of internal calibrated leak:
 - type of calibrated leak: internal (see chapter "Calibrated leak").
5. Check the parameters and value of the internal calibrated leak used (see chapter "Calibrated leak"). Correct the temperature, month and year if necessary.
6. Check the following parameters (correct if necessary):
 - type of calibrated leak: machine (see chapter "Calibrated leak")
 - Tracer gas = ^4He (see chapter "Tracer gas").
7. Select the tracer gas for the external calibrated leak (see chapter "Tracer gas").
8. Check the parameters and value of the external calibrated leak used (see chapter "Calibrated leak"). Correct the temperature, month and year if necessary.
9. Check that the detector is in 'Stand-by' mode.
10. Press the **[AUTOCAL]** function key to start the calibration.
11. Follow the instructions given by the leak detector. Press **[Next]** to move to the next step.

At the end of the calibration, the detector returns to 'Stand-by' mode.

7.5.4 Calibration in hard vacuum test with a pumping system in parallel

When the leak detector is connected to an installation equipped with its own pumping system, only part of the leak will be measured by the leak detector. Calibration gives a direct reading of the leak rate by taking into account the loss of tracer gas of the leak pumped by the pumping unit.

There are 2 methods to calibrate a detector with a pumping system in parallel:

- machine calibration: this method requires an internal calibrated leak.
This method is preferred if the detector is equipped with the 'Internal calibration' option/accessory (see chapter "Calibration in hard vacuum test with machine calibration").
- Correction function ('Autocor'): this method requires the detector to be calibrated beforehand by performing a calibration using the internal or external calibrated leak.

The coefficient is calculated using the Correction function

Correction function ('Autocor') procedure

Correction must be performed when the leak detector is already calibrated with its internal or external calibrated leak.

1. Allocate a function key to **[Correction]** (see chapter "Function keys").
2. Select the 'hard vacuum' or 'sniffer' test method (see chapter "Test method").
3. Sniffer test:
 - Connect the sniffer probe to the detector (accessory).
 - Connect the probe to an external calibrated leak or place it in a container with a known concentration.

4. Press the **START/STAND-BY** button to start a test.
5. Press the **[CORRECTION]** function key.
 - if the value of the correction factor to be applied is known:
 - Press **[Value]**.
 - Set the correction factor to be applied. The correction factor is the coefficient to be applied to the measured leak rate.
 - Press **[Return]** to exit the function.
 - If the correction factor value is unknown (value of the external calibrated leak or concentration):
 - Press **[Auto Cor] [Target]**.
 - Set the target value.
 - Press **[Run]** to make the correction.
 - Press **[Return]** to exit the function.

The **COR** indicator light is displayed on the control panel when the value of the correction factor is not 1.

The digital display takes into account the applied correction factor.

The bargraph display does not take into account the applied correction factor.

7.5.5 Calibration in sniffer test with external calibrated leak

The sniffer test requires the 'Sniffer' option/accessory (see chapter 'Accessories').

External calibrated leak (see chapter "Calibration").

1. Allocate a function key to **[AUTOCAL]** (see chapter "Function keys").
2. Configure the following settings:
 - test method: sniffer (see chapter "Test method").
 - type of calibrated leak: external sniffer (see chapter "Calibrated leak").
 - calibration: operator (see chapter "Leak Detection: Calibration").
3. Select the tracer gas for the external calibrated leak (see chapter "Tracer gas").
4. Verify the setting for the external calibrated leak used (see chapter "Calibrated leak").

Correct the temperature, month and year if necessary.

At the end of the calibration, the detector returns to its initial state ('Stand-by' or test mode).

Adaptor for external calibrated leaks

A DN 16 ISO-KF or DN 25 ISO-KF adaptor is used to calibrate the detector with an external calibrated leak in sniffer test mode (with standard sniffer probe only).

Adaptor part number (see chapter "Accessories").

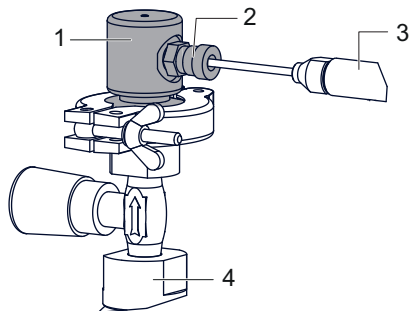

- | | |
|--|-------------------|
| 1 DN 16 ISO-KF or DN 25 ISO-KF adaptor | 3 Sniffer probe |
| 2 Fixing screws | 4 Calibrated leak |

1. Attach the adaptor to the external calibrated leak used for the calibration with a centering ring and a clamp.
2. Press the **[AUTOCAL]** function key to start a calibration.
3. Place the sniffer probe in the calibration port.
4. Tighten the fixing screw.
5. Follow the instructions given by the leak detector.
 - Press **[Next]** to move to the next step.
6. Loosen the fixing screw.
7. Remove the sniffer probe from the calibration port.

8. Follow the instructions given by the leak detector.
 - Press **[Next]** to move to the next step.
9. Wait 10 seconds (at least) before reading the leak rate.

7.5.6 Calibration in sniffer test on concentration

The sniffer test requires the 'Sniffer' option/accessory (see chapter 'Accessories').

Concentration = volume at atmospheric pressure filled with a gas mixture for which the tracer gas content is known.

Calibration on concentration can only be carried out in sniffer test mode, with the detector in 'Stand-by' or 'Test' mode.

Before starting this function, make sure that the leak detector is in an environment free of tracer gas pollution.

1. Allocate a function key to **[AUTOCAL]** (see chapter "Function keys").
2. Configure the following settings:
 - test method: sniffer (see chapter "Test method").
 - type of calibrated leak: concentration (see chapter "Calibrated leak").
 - calibration: operator (see chapter "Leak Detection: Calibration").
3. Select the tracer gas for the concentration (see chapter "Tracer gas").
4. Connect the sniffer probe to the detector.
5. Place the sniffer probe in the concentration.
6. The detector is in 'Stand-by' or test mode.
7. Press the **[AUTOCAL]** function key to start a calibration.
8. Follow the instructions given by the leak detector.
 - Press **[Next]** to move to the next step.

At the end of the calibration, the detector returns to its initial state ('Stand-by' or test mode).

7.5.7 Dynamic calibration

This function allows predictive adjustment of the leak rate for repetitive tests where the test time has to be optimized (see chapter "Leak detection: Dynamic calibration").

7.5.8 Calibration check

The calibration check enables the operator to save up to 50% time compared to an internal calibration (see chapter "Leak detection: Calibration").

7.6 Zero Function

The zero function is used to identify very small variations in the leak rate in the ambient background.

Zeroing

Configuration (see chapter "Zero activation").

Over time, there may be a deviation in the leak rate display. Zeroing must be performed regularly in the following cases:

- when the detector's background value increases,
- before performing a precise measurement.

1. Allocate a function key to **[Zero]** (see "Function keys").
2. Press the **[Zero]** button.

7.7 Touchscreen

The touch screen is interfaced with the detector and is used to:

- display information about the test,
- access the available functions,
- set the detector's parameters.

4 application screens are provided to the user to access this data.

The user can hide and/or change some screens in the loop (see chapter "Application windows").

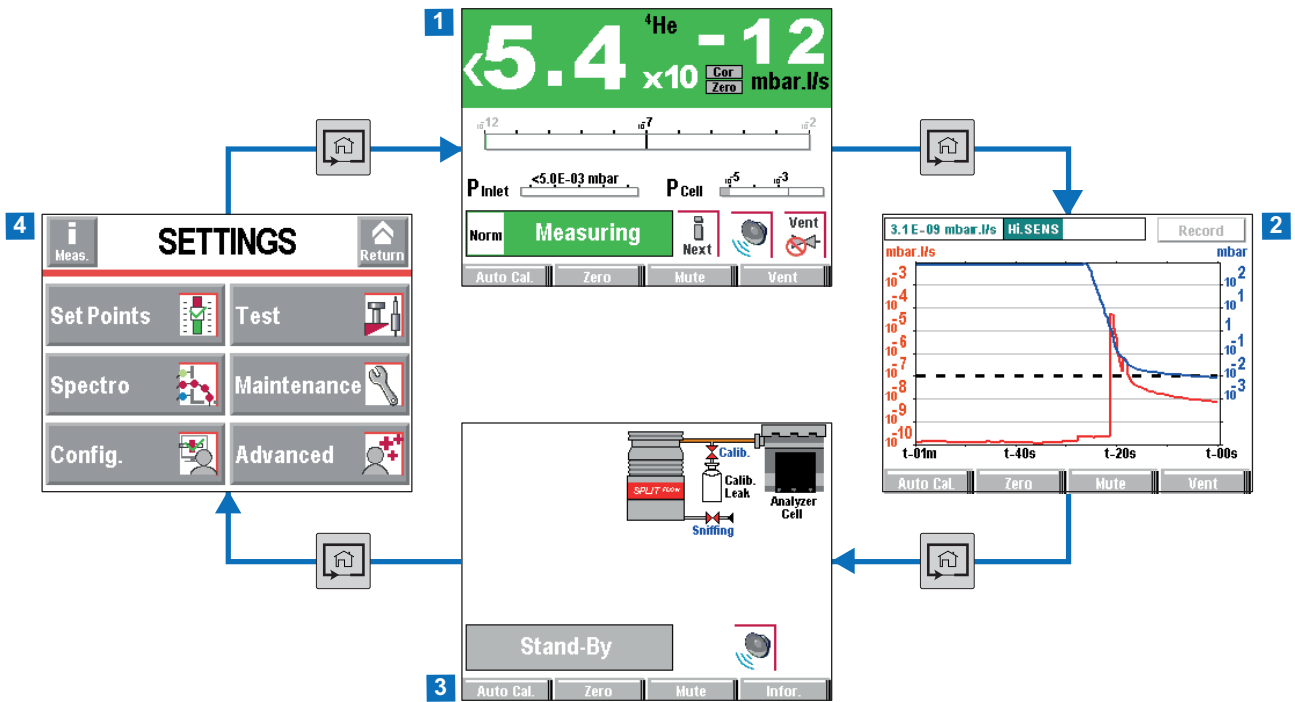

Example of each application screen

1	“Main” Screen (Standard)	Information about the current test
2	“Graph” screen	Monitoring and recording the leak rate and/or the inlet pressure
3	“Synoptic” screen	Schematic diagram of the detector and the status of the valves
4	“Settings” screen	Detector parameters

The contents of the screens are provided as an example: depending on the detector settings, the display may be different.

- ▶ Remove the film that protects the touch screen upon delivery.
- ▶ Use the touch screen manually without using hard objects such as pens, screwdrivers, etc.
- ▶ Use the RS-232 serial link to control/set the detector if the touch screen is out of service (broken screen).

Contrast - Brightness - Screen Saver

See chapter “Screen Settings”.

Screenshot

- ▶ To take a screenshot, allocate a function key to **[Screen Copy]** (see chapter “Function keys”).

Access to the application screens and the Settings menu

Access to the application screens and the Settings menu can be permitted or forbidden.

A user level can be allocated to the user.

- ▶ To permit/forbid access to the application screens, see chapter “Application windows” or chapter “Password”.
- ▶ To permit/forbid access to the Settings screen and user level attribution, see chapter “Access - Password”.

7.7.1 Navigation

Symbols

	Function deactivated (OFF)
	Function activated (ON)
	Authorized access without password

	Access locked: access with password
	"Pixelated" key: access prohibited for the product
	"Grey" key: access settings or function
	"White" key: key not customizable, for information
	"Measurement information" key: to display the measured leak rate
	Arrows for navigating within the menus
	Access to the error/warning window
	Value selected is customizable
	Keys for setting the values
	Moving to the next function/screen/parameter
	Return to the previous display
	Return to the previous display with confirming the changes made
	Return to the previous display without confirming the changes made
	Deleting the selected file

7.7.2 Main screen (home)

Information about the test.

- ▶ Access the main screen by pressing repeatedly on the key

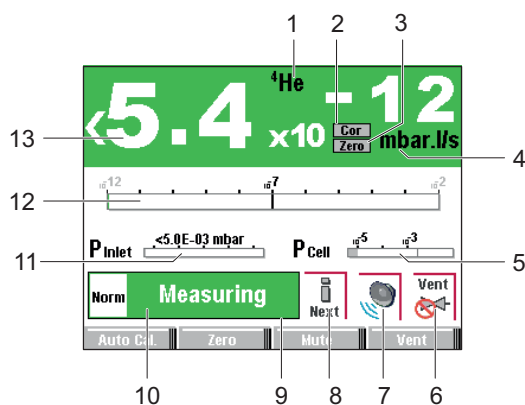

Item	Function
1	Tracer gas
2	COR indicator: correction factor applied
3	'Zero' function status indicator
4	Leak rate unit
5	Cell or external gauge pressure bargraph display
6	'Inlet vent' function status indicator
7	'Mute' function status indicator
8	Indicator : error/warning message to be consulted
9	'Purge' enabled function status indicator
10	Current status of the detector Detection mode

Item	Function
11	Detector inlet pressure bargraph display (unit consistent with the leak rate unit) 1 · 10 ³ permanently displayed if there is no pressure gauge connected
12	Leak rate Bargraph display (adjustable scale) (color depends on test results)
13	Digital display of leak rate The color of the screen varies depending on the test result: <ul style="list-style-type: none"> • green screen: measured leak rate below the reject point • red screen: measured leak rate above the reject point gray screen: detector in stand-by

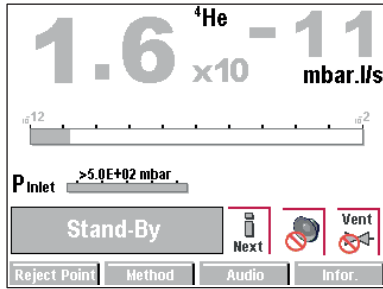

Main screen in 'Stand-by' mode

7.7.3 Graph screen

Monitoring and recording the leak rate and/or the inlet pressure.

- ▶ Access to graph screen by pressing repeatedly on the key .

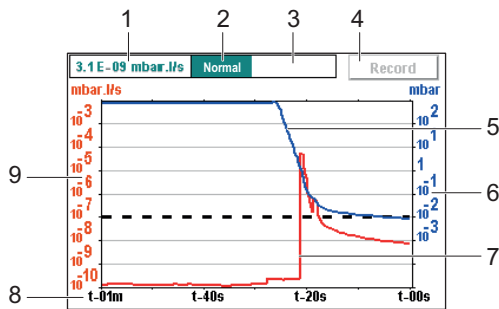

Item	Function
1	Digital display of leak rate
2	Current status of the detector Detection mode
3	COR indicator: correction factor applied ZERO indicator: zero function activated
4	Recording a plot
5	Inlet pressure plot (in blue) 1 · 10 ³ permanently displayed if there is no pressure gauge connected
6	Inlet pressure scale (in blue) ¹⁾
7	Plot of the tracer gas leak rate (in red)
8	Time scale ¹⁾
9	Scale of the tracer gas leak rate (in red) ¹⁾

1) Adjustable scale by pressing the graph

7.7.4 Graph screen: graph parameters

- ▶ Press on the screen to access the graph parameters.

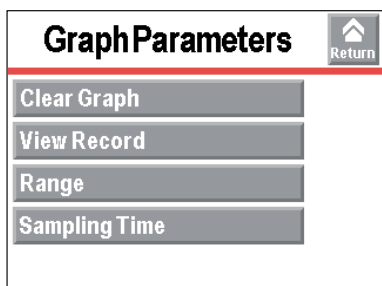

Access: Press on the screen to access the graph parameters.

Clear Graph	To be launched Graph clearing (see chapter “Graph screen: Graph clearing”).
View Record	To be set Saving and viewing of a recording (see chapters “Graph screen: saving a recording” and “Graph screen: viewing a recording”).
Range	To be set Configuration of the graph scales (see chapter “Graph screen: scales”).
Sampling Time	To be enabled Recording a graph (see chapter “Graph screen: recording a graph”).

7.7.5 Graph screen: graph clearing

- ▶ Press on the screen to access the graph parameters.

Clearing the current window

1. Press **[Clear Graph]**.
2. Validate the message.

Clearing the current window does not delete the current recording or recordings already made.

Clearing the current recording

1. Press **[View Record]**.
2. Press **[Clear]**.
3. Validate the message.

7.7.6 Graph screen: recording a graph

Recording makes it possible to store the measurements taken during the test in the control panel memory: **it will not save these measurements.**

During recording, all of the leak detector functions are available.

If the memory is not cleared between two recordings, (**[Clear]** (see chapter “Graph screen: Graph clearing”)), all successive recordings will follow each other on the same stored plot. A (Δ) cursor indicates the change in recording.

After the detector is switched off (cut off at the mains or by the operator), the recordings already made are stored in the memory. For the next recording, the operator will have to specify:

- if the new recording is to be added to the recordings in the memory **[OK]**.
- if the new recording is to delete and replace the recordings in the memory **[Cancel]**.

Configuration

Press the graph, then [Record], to modify the recording parameters		Choice - Setting limit ¹⁾
Duration	To be set Recording duration See details below	0.2 s – 30 s
Capacity	Read only Total recording time according to configured recording duration See details below	-

1) Initial setting: see chapter “Tree diagram of the Settings menu”

Recording duration detail

Duration	Maximum capacity	File size
0.2 s (minimum)	6 hours 33 minutes	≈ 7 Mo
30 s (maximum)	983 hours 32 minutes	

1. Configure the recording parameters.
2. Configure the graph parameters (see chapter “Graphic screen: scales”).
3. Press **[Record]** to start recording.
 - None of the measurements displayed on the plot before the recording starts will be recorded.
4. Press **[Stop]** to stop recording.
5. Press the graph and **[View Rec.]** to see the recording.

Recording example

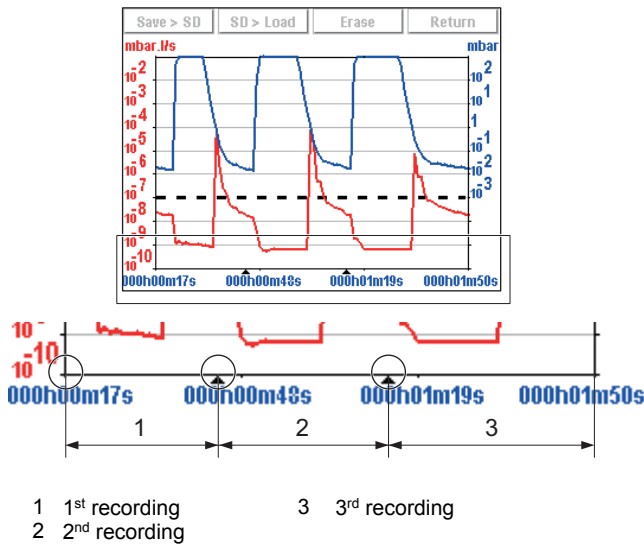

When the memory is full and a recording is in progress, recording is automatically stopped. The **[Record]** key is replaced by the **[Mem. full]** key.

7.7.7 Graph screen: scales

- ▶ Press the graph and **[Range]** to modify the graph parameters.

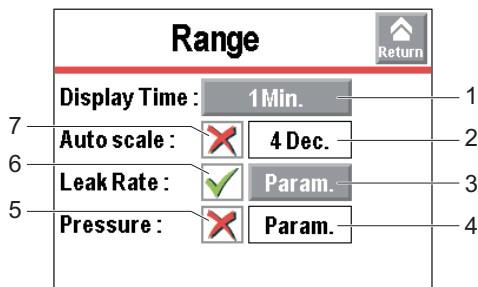

1	Period of time displayed on the screen
2	Setting the automatic scale
3	Setting the measured leak rate scale
4	Setting the inlet pressure scale
5	Displaying/Hiding the inlet pressure
6	Displaying/Hiding the measured leak rate
7	Activating/Deactivating the automatic scale

Access: Press the graph and [Scale] to modify the graph parameters.		Choice - Setting limit ¹⁾
Display Time	To be set Period of time displayed on the screen	Rapid / 1 min / 2 min / 3 min / 6 min / 12 min / 30 min / 1 h / 2 h
Auto scale	To be enabled The automatic scale is used to display the measured leak rate centered on 2 or 4 decades. The scale varies according to the leak rate measured. When the automatic scale is activated, the scales set for the leak rate and pressure are no longer taken into account.	Activated Deactivated
	To be selected Setting the automatic scale Example: leak rate = $5 \cdot 10^{-7}$ mbar · l/s ($5 \cdot 10^{-8}$ Pa · m ³ /s) <ul style="list-style-type: none"> automatic scale 2 decades: scale from $1 \cdot 10^{-6}$ to $1 \cdot 10^{-8}$ mbar · l/s ($1 \cdot 10^{-7}$ to $1 \cdot 10^{-9}$ Pa · m³/s) automatic scale 4 decades: scale from $1 \cdot 10^{-5}$ to $1 \cdot 10^{-9}$ mbar · l/s ($1 \cdot 10^{-6}$ to $1 \cdot 10^{-10}$ Pa · m³/s) 	2 decades 4 decades
Leak Rate	To be enabled Displaying/Hiding the measured leak rate	Activated Deactivated
	To be set Setting the leak rate scale (If 'automatic' scale is deactivated)	Decade Max Decade Min
Pressure	To be enabled Displaying/Hiding the inlet pressure	Activated Deactivated
	To be set Configuration of the maximum decade for the inlet pressure	Decade Max

1) Initial setting: see chapter "Tree diagram of the Settings menu"

7.7.8 Graph screen: saving a recording

This function is used to save the most recent recording on a SD card to be played back/analyzed later on a computer. Saving is not automatic.

It is possible to save a screenshot of the recording (.bmp) or to generate a file (.txt) with all the measurements taken. The .txt file allows subsequent processing: the 'tab' separator is used by default.

1. Press the screen and on **[View Rec.] [Save > SD]**.
2. Choose the file type.
3. Name the file and save it.

The saved .bmp and .txt files include only the measurement points displayed on the screen:

- to include all points, you must be positioned on the relevant plot (without zooming).
- if a zoom was carried out before saving, the zoom will apply only to the points of the selected area.

If the saved recording is made up of several consecutive recordings:

- The (Δ) cursor indicates each change of recording on .bmp files.
- "B.P. # xx" will be noted at the end of the last line of each recording in the .txt files.

The .bmp files can be displayed on the control panel screen.

The .txt files can only be opened from a computer: they cannot be viewed from the control panel.

7.7.9 Graph screen: viewing a recording

At any time, a saved file can be viewed or a zoom can be performed on it, without stopping an ongoing recording.

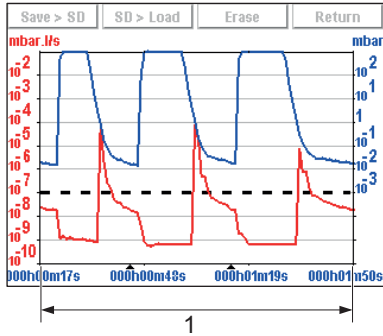

1 Total recording time

- ▶ Press the graph and **[View Record]** to view the recording made since the last recording was deleted.
 - If no plots have been made, the message “Memory empty” is displayed.

Zoom in

Zoom in available only for a recording.

Several successive zooms are possible (except in the same decade).

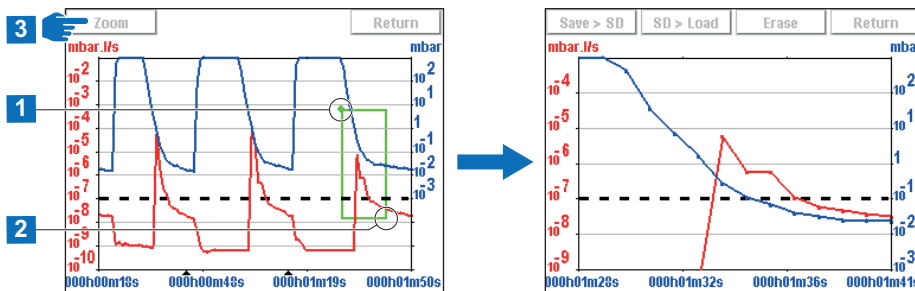

1. Press the graph.
2. Press **[View Rec.]**.
3. Define the area to be enlarged by selecting 2 points.
4. Press **[Zoom]**: the enlarged area is displayed.



If necessary, adjust the area to be enlarged by dragging the corners or sides with finger.

Zoom out

Zoom out available only for a recording.

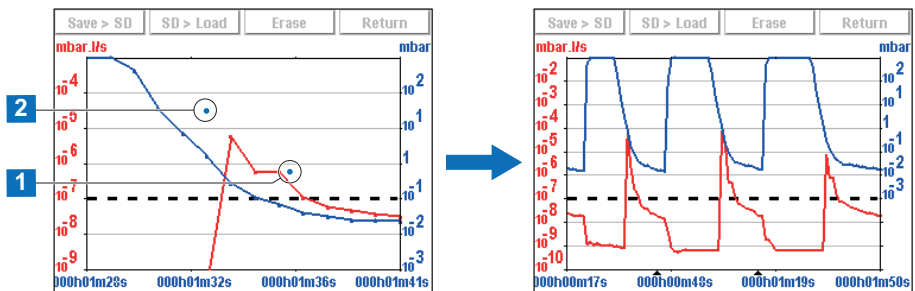

1. Press twice on the zoom to return to the original graph.
 - The 2nd press should always be done to the left of the 1st on the screen: see the example above.

Measurement

Exact measurement of a point, only available on a recording.

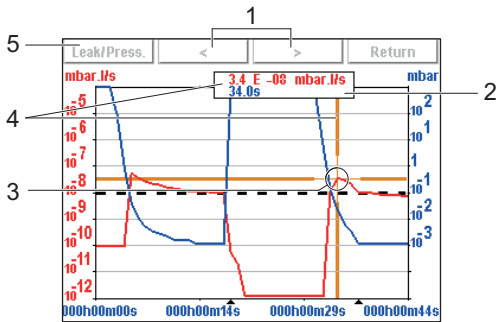

- 1 Navigation between next/previous recorded points
 - 2 Displaying the tracer gas leak rate (in red) or the inlet pressure (in blue)
 - 3 Marker indicating the selected point
 - 4 Moment the measurement took place in relation to the start of the recording
 - 5 Selecting the display of the leak rate or the inlet pressure
1. Select the point to measure.
 2. Press **[Measure]**: the exact measurement of the selected point is displayed.



To have the exact values of all the measurements, save the recording in a .txt file.

7.7.10 Settings screen

The Settings screen allows the user to access 6 menus for configuring the product to user specifications (see chapter “Settings”).

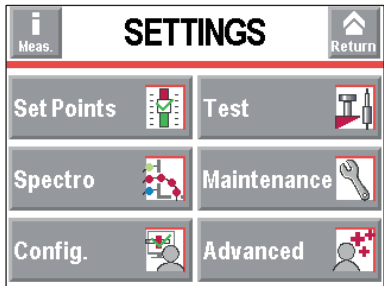

Access to Settings screen:

- by pressing repeatedly on the key ,
- by pressing 2 keys + simultaneously on the control panel.



It is possible to password lock access to the Settings menus while keeping some functions available via the function keys (see chapter “Application windows”).

Temporary access to a locked menu

Temporary access: after returning to the main screen, the menu is once again locked.

- ▶ See chapter “Access - Password”.

7.7.11 Synoptic screen

The vacuum circuit corresponds to the detector’s schematic diagram.

The vacuum circuit displayed is specific to each detector model.

The vacuum circuit varies depending on the status of the valves, but does not make it possible to manage the valves.

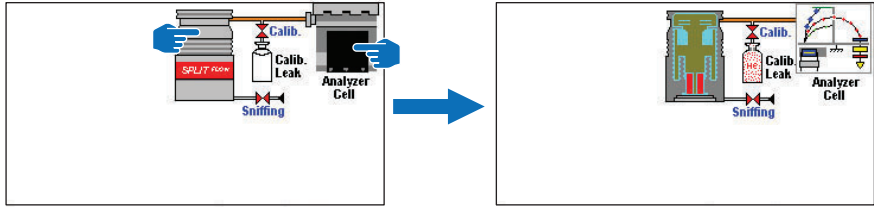

Vacuum circuit example

Component	Description
Red valve	Valve closed
Green valve	Valve open
Pumps	Press the component to display the operating principle.
Analyzer cell	

► Access the Synoptic screen by pressing repeatedly on the key .

7.7.12 'Measurement' window

1. Press the **[Measure]** key to display the window.
2. Press and drag the window to move it on the screen.

[Measure] key and the corresponding window

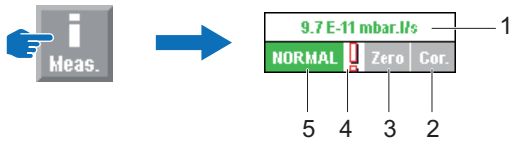

Item	Function
1	Digital display of leak rate The display color varies depending on the results of the test: <ul style="list-style-type: none"> • green screen: measured leak rate below the reject point • red screen: measured leak rate above reject point
2	COR indicator: correction factor applied
3	Zero indicator: zero function activated
4	Error information indicator Indicator !: error/warning message to be consulted
5	Detection mode

8 Settings

The Settings screen allows the user to access 6 menus for configuring the product to use specifications. See chapter “Settings Screen”.

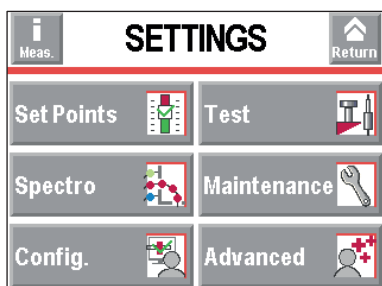

Functions by menu

[SET POINTS] menu

- Audio alarm
- Digital voice
- Pollution function
- Backgnd Max
- Hard vacuum reject point
- Sniffer reject point
- Other pressure set points

[TEST] menu

- Test method
- Correction factor
- Test mode/Probe type (depending on test method set)
- Automatic cycle end
- Zero activation
- Memo Function

[SPECTRO] menu

- Tracer gas
- Filament parameters
- Calibrated leak

[MAINTENANCE] menu

- Detector
- Timers
- Detector Information
- Pump Information
- Events history
- Calibrations history
- Last maintenance

[CONFIGURATION] menu

- Unit/Date/Time/Language
- Function keys
- Application windows
- Screen settings
- Access - Password

[ADVANCED] menu

Advanced functions reserved for specific detector uses.

- Leak Detection: Start-up timer
 - Leak Detection: Detector pressure gauge
 - Leak Detection: External gauge
 - Leak Detection: Calibration
 - Leak Detection: Analyzer cell
 - Leak Detection: Dynamic calibration
 - Leak Detection: Signal processing
 - Input/Output: Serial link and Serial link 2
 - Input/Output: I/O connector
 - SD card menu
 - Secondary pump speed
 - Service
-

8.1 Set points menu

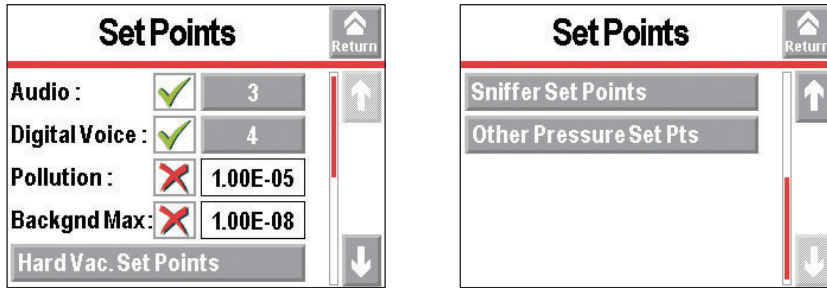

8.1.1 Audio alarm and digital voice

This menu is used to configure the sound volumes.

The audio alarm and the digital voice are not available directly on the detector. Either:

- an audio headphone or loudspeaker must be connected (maximum power: 0.5 W) on the outputs of the 15/37-pin I/O communication interface connector (option/accessory) (refer to the user manual for the communication interface)
- or connect a buzzer to the control panel (see chapter “Attaching the industrial control panel”)

The headphones, the loudspeaker and the buzzer should be ordered separately.

Access: Settings Screen + Menu [Set Points]		Choice - Setting limit ¹⁾
Audio alarm	To be enabled The audio alarm informs the user that the reject point has been crossed.	Enabled Disabled
	To be set Level 9 = 90 dB(A)	0 – 9
Digital Voice	To be enabled The digital voice informs the user about the status of the detector or actions to be carried out.	Enabled Disabled
	To be set Level 9 = 90 dB(A)	0 – 9

1) Initial setting: see chapter “Tree diagram of the Settings menu”



For quick access from the main screen, configure a function key to **[AUDIO]** (see chapter “Function keys”).

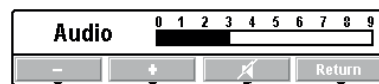

For quick access from the main screen, configure a function key to **[DIGITAL VOICE]** (see chapter “Function keys”).



Set a function key to **[MUTE]** (see chapter “Function keys”).

From the main screen, use the **[MUTE]** key to simultaneously cut off the sound alarm and the digital voice.

On the control panel, the red cross on the pictograph indicates that the “Mute” function is enabled.

8.1.2 Pollution function

This menu enables protection of the leak detector from pollution by preventing too much of the tracer gas coming from the leak from penetrating the detector.

When the set pollution threshold is exceeded:

- an audible signal is emitted to indicate that the detector is in 'Standby' mode
- a message (W222) is displayed informing that the 'Pollution' function is activated.

Access: Settings Screen + [Setpoints] Menu		Choice - Setting limit ¹⁾
Pollution	To be enabled	Enabled Disabled
	To be set We recommend setting the pollution set point to a maximum of 4 decades above the reject set point. If the leak rate rapidly increases above the pollution set point, the cycle stops automatically and the leak detector returns to Stand-by mode.	$1 \cdot 10^{+19} - 1 \cdot 10^{-19}$

1) Initial setting: see chapter "Tree diagram of the Settings menu"



Useful function if the part or installation to be tested is likely to have gross leaks.

8.1.3 Background maximum

This function protects the detector and the installation under test from any tracer gas pollution by prohibiting any test if the background noise of the detector is greater than a predefined threshold.

Access: Settings Screen + Menu [Set Points]		Choice - Setting limit ¹⁾
Backgnd Max	To be enabled	Enabled Disabled
	To be set	$1 \cdot 10^{+19} - 1 \cdot 10^{-19}$

1) Initial setting: see chapter "Tree diagram of the Settings menu"

8.1.4 Hard vacuum reject point

This menu is used to define the hard vacuum reject point.

The reject point is the acceptance threshold for tested parts.

Access: Settings Screen + Menu [Set Points] [Hard Vacuum Set Points]		Choice - Setting limit ¹⁾
Reject point	To be set for each tracer gas The reject point is the acceptance set point for parts. <ul style="list-style-type: none"> • Measured leak rate < reject point: part accepted • Measured leak rate > reject point: part rejected Display of the test results: <ul style="list-style-type: none"> • Measured leak rate < Reject set point <ul style="list-style-type: none"> – Screen: green – Bargraph: white – Graph: red line • Measured leak rate > Reject set point <ul style="list-style-type: none"> – Screen: red – Bargraph: white – Graph: red line 	$1 \cdot 10^{+06} - 1 \cdot 10^{-13}$
Reject point 2/3/4/5a	To be set 4 additional thresholds are available with the 37-pin I/O communication interface (option/accessory).	$1 \cdot 10^{-19} - 1 \cdot 10^{+19}$

1) Initial setting: see chapter "Tree diagram of the Settings menu"



For quick access from the main screen, configure a function key to **[REJECT POINT]** (see chapter "Function keys").



Set point setting

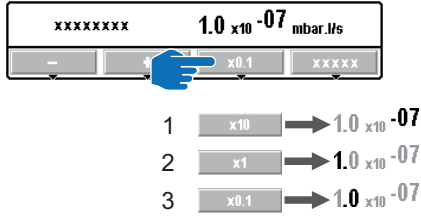

- 1 Exponent setting
- 2 Mantissa unit setting
- 3 Mantissa tenth setting

8.1.5 Sniffer reject point

This menu is used to define the reject point in sniffing.
 The reject point is the acceptance threshold for tested parts.

Access: Settings Screen + Menu [Set Points] [Sniffer Set Point]		Choice - Setting limit ¹⁾
Reject point	To be set The reject point is the acceptance set point for parts. <ul style="list-style-type: none"> • Measured leak rate < reject point: part accepted • Measured leak rate > reject point: part rejected Display of the test results: <ul style="list-style-type: none"> • Measured leak rate < Reject set point <ul style="list-style-type: none"> – Screen: green – Bargraph: white – Graph: red line • Measured leak rate > Reject set point <ul style="list-style-type: none"> – Screen: red – Bargraph: white – Graph: red line 	$1 \cdot 10^{+06} - 1 \cdot 10^{-12}$

1) Initial setting: see chapter "Tree diagram of the Settings menu"



For quick access from the main screen, configure a function key to **[REJECT POINT]** (see chapter "Function keys").



Set point setting

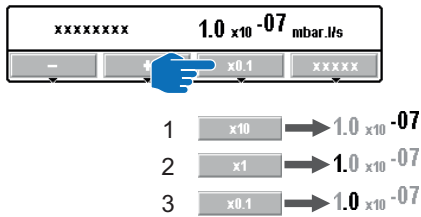

- 1 Exponent setting
- 2 Mantissa unit setting
- 3 Mantissa tenth setting

8.1.6 Probe clogged threshold

This menu is used to set the probe clogged threshold to verify that the sniffer probe (accessory) is operational.

When the probe flux is below the 'Probe clogged' threshold, the icon  is displayed to make the user aware of this information.

Access: Settings Screen + Menu [Set Points] [Sniffer Set Point]		Choice - Setting limit ¹⁾
Probe clogged	To be set The threshold unit is the unit set for the detector.	$1 \cdot 10^{+19} - 1 \cdot 10^{-19}$

1) Initial setting: see chapter "Tree diagram of the Settings menu"



Block the end of the sniffer probe from time to time with your finger to check that the leak rate is going down. If not, the probe may be clogged.
Do not block the end for too long: if the measured leak rate decreases too much, there is risk of exiting the sniffer test.

8.1.7 Other pressure set points

This menu is used to provide 3 other pressure set points managed by the 37-pin I/O communication interface (see the operating instructions for the communication interface).

- pressure set point #1: threshold for switching to Gross Leak mode
- pressure set point #2: threshold for switching to Normal mode
- pressure set point #3: threshold for switching to High Sensitivity mode

Frequency	Test mode in progress	Max. crossover threshold in the current test mode	State of the valves in the current test mode		
			Test valve 1 (Gross Leak mode)	Test valve 2 (Normal)	Test valve 3 (High Sensitivity)
1500 Hz	Gross Leak	Set point 1 = 18 hPa (18 mbar)	Open	Closed	Closed
	Normal	Set point 2 = 1 hPa (1 mbar)	Closed	Open	Closed
	High Sensitivity	Set point 3 = 0.2 hPa (0.2 mbar)	Closed	Closed	Open
1000 Hz	Gross Leak	Set point 1 = 18 hPa (18 mbar)	Open	Closed	Closed
	Normal	Set point 2 = 3.5 hPa (3.5 mbar)	Closed	Open	Closed
	High Sensitivity	Set point 3 = 0.1 hPa (0.1 mbar)	Closed	Closed	Open

See chapter "Gauge connection - Setting"

Prerequisites

- Detector equipped with 37-pin I/O communication interface (option/accessory).
- Installation equipped with an external gauge (order separately)

Access: Settings Screen + Menu [Set Points] [Other Pressure Set Points]		Choice - Setting limit ¹⁾
Pressure set point #1/2/3	To be set Pressure set point #1 < Pressure set point #2 < Pressure set point #3	$5 \cdot 10^{-5} - 3 \cdot 10^{+2}$

1) Initial setting: see chapter "Tree diagram of the Settings menu"

8.2 Test menu

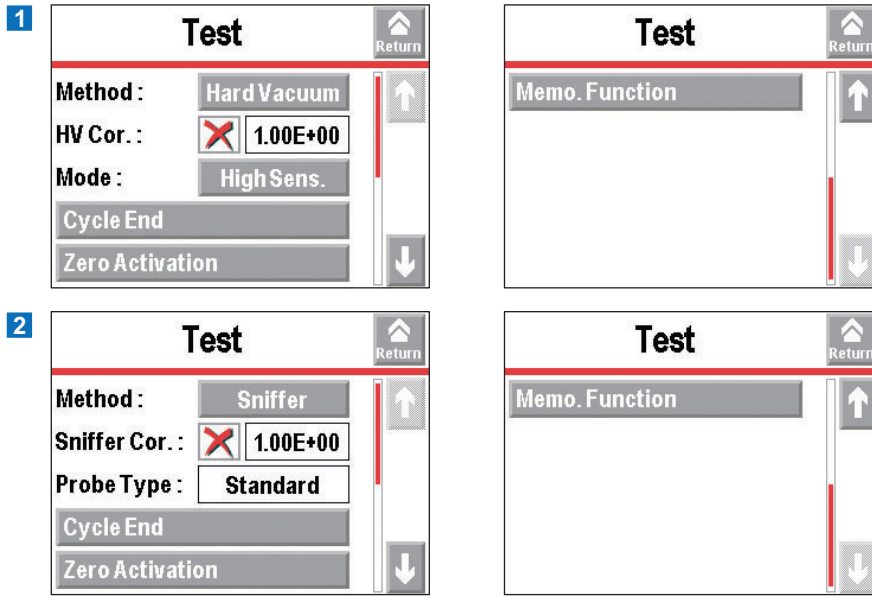

1 Test menu with 'Hard Vacuum' test method

2 Test menu with 'Sniffer' test method

8.2.1 Test method

This menu is used to select a test method.

The sniffer test requires the 'Sniffer' option/accessory (order separately: see chapter 'Accessories').

Access: Settings Screen + Menu [Test]		Choice - Setting limit ¹⁾
Method	To be selected The test method is chosen depending on the part to be tested. For more information about leak detection test methods, see Leak detector compendium on the www.pfeiffer-vacuum.com website.	Hard vacuum Sniffer

1) Initial setting: see chapter "Tree diagram of the Settings menu"



Tracer gas or test method setting modification

The selected test method and tracer gas have an impact on the calibration. It is mandatory to perform a calibration of the detector if one of the following parameters is modified:

- test method (hard vacuum or sniffing)
- tracer gas (⁴He, ³He or H₂)



For quick access from the main screen, configure a function key to **[METHOD]** (see chapter "Function keys").



By default, the leak detector is set to work in a hard vacuum test, in the most sensitive test mode: this setting meets the majority of users' needs.

8.2.2 Correction factor

The correction factor allows correction for the leak rate measured by the leak detector when:

- the detector is combined with parallel pumping,
- the concentration of tracer gas is lower than 100%.

Display

The **COR** indicator light is displayed on the control panel when the correction factor value is not 1.

The leak rate displayed takes into account the correction factor applied.



Use of the correction factor must not replace calibration.

Access: Settings Screen + Menu [Test]		Choice - Setting limit ¹⁾
HV correction	To be enabled	Enabled Disabled
	To be set If the correction factor is not known, from the [Correction] function key, click on [Auto Cor] : this function calculates the correction factor to be applied and applies it automatically.	$1 \cdot 10^{+20} - 1 \cdot 10^{-20}$

1) Initial setting: see chapter "Tree diagram of the Settings menu"



For quick access from the main screen, configure a function key to **[COR]** (see chapter "Function keys").

**Example**

The table below shows the leak rate displayed according to the correction factor applied.

Example: leak rate displayed with a calibrated leak of $1 \cdot 10^{-7}$ mbar · l/s ($1 \cdot 10^{-8}$ Pa · m³/s) (with 100% ⁴He)

% ⁴ He in the gas used	100%	50%	5%	1%
Leak rate displayed on the leak detector without correction factor	$1 \cdot 10^{-7}$ mbar · l/s ($1 \cdot 10^{-8}$ Pa · m ³ /s)	$5 \cdot 10^{-8}$ mbar · l/s ($5 \cdot 10^{-9}$ Pa · m ³ /s)	$5 \cdot 10^{-9}$ mbar · l/s ($5 \cdot 10^{-10}$ Pa · m ³ /s)	$1 \cdot 10^{-9}$ mbar · l/s ($1 \cdot 10^{-10}$ Pa · m ³ /s)
Correction factor value	1	2	20	100
Leak rate displayed on the leak detector with correction	$1 \cdot 10^{-7}$ mbar · l/s ($1 \cdot 10^{-8}$ Pa · m ³ /s)			

8.2.3 Test mode

This menu lets you to select a test mode with the hard vacuum test method.

The leak detector will automatically switch to the test mode selected when the internal pressure reaches the crossover threshold (see chapter "Leak Detection: Crossover Pressure").

Access: Settings Screen + Menu [Test]		Choice - Setting limit ¹⁾
Mode	To be selected The selected test mode corresponds to the port used to connect the detector. Example: the detector is connected to the Normal port: the 'Normal' test mode must be selected (see chapter "Connection of the installation to be tested").	Gross Leak Normal High Sensitivity

1) Initial setting: see chapter "Tree diagram of the Settings menu"



For quick access from the main screen, configure a function key to **[MODE]** (see chapter “Function keys”).

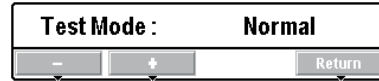

By default, the leak detector is set to work in a ‘Hard vacuum’ test method, in the most sensitive test mode: this setting meets the majority of users’ needs.

8.2.4 Probe type

This menu is used to select the sniffer probe type used in sniffing (see chapter “Accessories”).

Access: Settings Screen + Menu [Test]		Choice - Setting limit ¹⁾
Probe type	To be selected Standard sniffer probe: model with rigid nozzle only	Standard Smart

1) Initial setting: see chapter “Tree diagram to the Settings menu”



Set the probe clogged threshold to verify that the sniffer probe is operational (see chapter “Probe clogged threshold”).

8.2.5 Automatic cycle end

This function allows automatic control of the roughing time and measurement time in a hard vacuum test.

Access: Settings Screen + Menu [Test] [Cycle End]		Choice - Setting limit ¹⁾
Cycle end	To be selected <ul style="list-style-type: none"> Operator: manual cycle end by the user Automatic: automatic cycle end based on configuration below. 	Operator Automatic
Rough. timer (If hard vacuum test method) (If cycle end)	To be enabled Roughing duration check	Enabled Disabled
	To be set (optional) Maximum permitted roughing duration. If the control is enabled and the maximum duration is reached (detector still roughing), the test stops and the part is rejected.	0 – 1 hr
Threshold report (If sniffer test method) (If cycle end)	To be enabled Timer before the measured leak control	Enabled Disabled
	To be set (optional) Delay If the measured leak is greater than the set reject set point when the timer runs out, the test is stopped and the part is rejected (protection of the detector in case of gross leak).	0 – 1 hr
Test timer (If cycle end)	To be set (required) Duration of measurement. When the measurement duration is reached, the test stops and the measured leak rate is displayed.	0 – 1 hr

1) Initial setting: see chapter “Tree diagram of the Settings menu”



Function to be used to automate a small production.

8.2.6 Zero activation

This function helps the user to identify very small leak rate variations in the surrounding background noise or to dilate small measured leak rate fluctuations on the analog display.

When the zero function is activated, a 2-decade bargraph appears on the main screen.

Access: Settings Screen + Menu [Test] [Zero Activation]		Choice - Setting limit ¹⁾
Activation	To be selected <ul style="list-style-type: none"> None: ZERO button inactive Operator: user activation by pressing on the [ZERO] function key, depending on configuration (see below: Zero Exit) Automatic: depending based on configuration (see below: Trigger) 	Operator Automatic
Zero Exit (if 'operator' activation)	To be selected Type of press to exit the function (see below) <ul style="list-style-type: none"> Press once: activate/deactivate zero by quickly pressing the [ZERO] function key. Press > 3 s: <ul style="list-style-type: none"> activation: quickly press the [ZERO] function key. Each time the key is pressed quickly, a new zero is carried out. deactivation: press > 3 s on the [ZERO] function key. 	Press once Press > 3 s
Trigger (if 'automatic' activation)	To be selected Factor for initiating the carrying out of another zero.	Timer Set point
	To be set Initiation value	0 – 1 h (if Timer) $1 \cdot 10^{+19}$ – $1 \cdot 10^{-19}$ (if Set point)

1) Initial setting: see chapter "Tree diagram of the Settings menu"



For quick access from the main screen, configure a function key to **[ZERO]** (see chapter "Function keys").



Using this function is recommended when the background of the tracer gas is stable. This function is used to measure a leak rate that is lower:

- than 2 decades in hard vacuum test mode: $1 \cdot 10^{-12}$ mbar · l/s ($1 \cdot 10^{-13}$ Pa · m³/s) minimum
 - than 3 decades in sniffing mode: $1 \cdot 10^{-8}$ mbar · l/s ($1 \cdot 10^{-9}$ Pa · m³/s) minimum
- than the detector's background, when the detector is no longer in roughing.

8.2.7 Memo function

This function freezes the main screen at the end of a test: the last measured leak rate from the test is displayed and flashes.

Access: Settings Screen + Menu [Test] [Memo Function]		Choice - Setting limit ¹⁾
Active	To be enabled Activation of the Memo function	No Yes
Display Time	To be enabled <ul style="list-style-type: none"> Enabled = the value of the measured leak rate flashes for the set duration. Disabled = the value of the measured leak rate will flash until a new test begins. 	Enabled Disabled
	To be set Display time	0 – 1 h

1) Initial setting: see chapter "Tree diagram of the Settings menu"



For quick access from the main screen, configure a function key to **[Memo]** (see chapter "Function keys").



8.3 Spectro menu

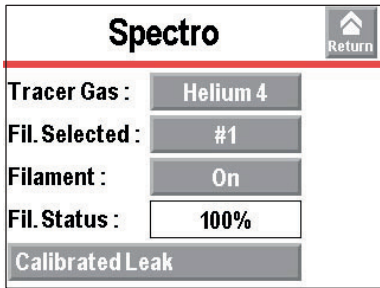

8.3.1 Tracer gas

This menu is used to select the tracer gas.

Access: Settings Screen + Menu [Spectro]		Choice - Setting limit ¹⁾
Tracer gas	To be selected The tracer gas is the gas searched for during a test.	Helium 4 Helium 3 Hydrogen

1) Initial setting: see chapter "Tree diagram of the Settings menu"



Tracer gas or test method setting modification

The selected test method and tracer gas have an impact on the calibration. It is mandatory to perform a calibration of the detector if one of the following parameters is modified:

- test method (hard vacuum or sniffing)
- tracer gas (⁴He, ³He or H₂)



For quick access from the main screen, configure a function key to [TRACER GAS] (see chapter "Function keys").



Hydrogen test

⚠ WARNING

Risk of injury due to the use of hydrogen as tracer gas

Hydrogen can be used as a tracer gas for leak detection. Depending on its concentration, in the worst scenario, there may be a risk of explosion.

- ▶ Never use a tracer gas with a hydrogen content greater than 5%.
- ▶ Use hydrogenated nitrogen as a tracer gas: mix of 95% N₂ and 5% H₂.

The detector's background is higher in H₂ than in ⁴He/³He.

Typical background in H₂, in test, when the detector is equipped with a blanking plate on the inlet port:

- at start-up: low range ± 1 · 10⁻⁵ mbar · l/s (1 · 10⁻⁶ Pa · m³/s)
- after 2 or 3 hours: low range ± 1 · 10⁻⁶ mbar · l/s (1 · 10⁻⁷ Pa · m³/s)

8.3.2 Filament parameters

Access: Settings Screen + Menu [Spectro]		Choice - Setting limit ¹⁾
Filament selected	To be selected Filament in use for the measurement (2 filaments in the analyzer cell).	1 2
Filament	To be selected Status of the filament in use when the detector is on. <ul style="list-style-type: none"> Off: filament off On: filament on 	Off On
Filament status	Read only Performance indicator of the analyzer cell for the selected filament. <ul style="list-style-type: none"> Default settings: between 90% and 100% Normal operation: between 10% and 100% The value of this indicator is updated after a leak detector calibration. Normal wear on some cell components will reduce this value over time but will not reduce the accuracy of the detector's measurements.	-

1) Initial setting: see chapter "Tree diagram of the Settings menu"

8.3.3 Calibrated leak

Information concerning calibrated leaks (see chapter "Calibration")

Access: Settings Screen + Menu [Spectro] [Calibrated leak]		Choice - Setting limit ¹⁾
Tracer gas	To be selected The tracer gas is the gas searched for during a test. This is the gas contained in the calibrated leak used for calibration.	Helium 4 Helium 3 Hydrogen
Type	To be selected Type of calibrated leak used for calibration <ul style="list-style-type: none"> Internal: 'Hard vacuum' test method, calibration based on leak detector's internal calibrated leak (⁴He leak only). Calibration with an internal calibrated leak requires the 'Internal calibration' option/accessory (see chapter "Accessories"). External: 'Hard vacuum' test method, calibration based on external calibrated leak (⁴He, ³He, or ₂H). Machine: 'Hard vacuum' test method, calibration based on the leak detector's internal calibrated leak (⁴He leak only) and external calibrated leak (⁴He, ³He or H₂ leak). External sniffer: 'Sniffer' test method, calibration based on external calibrated leak (⁴He, ³He, or ₂H leak). Concentration: 'Sniffer' test method, calibration using a volume at atmospheric pressure filled with a gas mixture whose tracer gas concentration is known. 	Internal External Machine External sniffer Concentration
Unit	To be selected Unit of calibrated leak used for calibration ²⁾	mbar · l/s Pa · m ³ /s Torr · l/s atm · cc/s ppm ³⁾
Leak value	To be set Value of calibrated leak used for calibration ²⁾	1 · 10 ⁺¹² – 1 · 10 ⁻¹²
Calibration valve	To be selected Current state of calibration valve Used to open/close the manual calibration valve, for example. Remember to close the valve again after use. Manual calibration is reserved for experts only.	Open Closed

1) Initial setting: see chapter "Tree diagram of the Settings menu"

2) Use the information indicated on the calibrated leak used for calibration or on its calibration certificate.

3) If 'Sniffer' test method selected

Access: Settings Screen + Menu [Spectro] [Calibrated leak]		Choice - Setting limit ¹⁾
Loss per Year (%)	To be set Set the loss per year for the calibrated leak used for calibration ²⁾	0 – 99
Ref. T. (°C)	To be set Reference temperature for the calibrated leak used for calibration ²⁾	0 – 99
Temp. Coeff. (%/°C)	To be set Temperature coefficient for the calibrated leak temperature used for calibration ²⁾	0.0 – 9.9
Year	To be set Month and year of calibration for the calibrated leak used for calibration ²⁾	-
T. Internal (°C) (if Type = internal)	Read only Temperature of the detector's internal calibrated leak	-
T. External (°C) (if Type = external)	To be set Configuration of external temperature	0 – 99

1) Initial setting: see chapter “Tree diagram of the Settings menu”

2) Use the information indicated on the calibrated leak used for calibration or on its calibration certificate.

3) If 'Sniffer' test method selected

In case of leak replacement, these parameters must be updated.

When the parameters are saved, all the data from all the set calibrated leaks (1 internal leak (⁴He) and 3 external leaks (⁴He, ³He and H₂)) is saved.

8.4 Maintenance menu

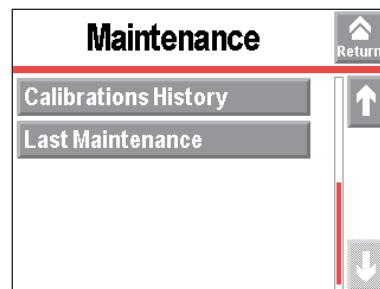
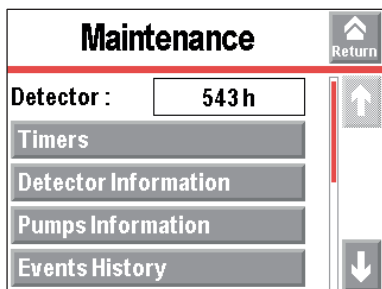

8.4.1 Detector

Access: Settings Screen + Menu [Maintenance]	
Detector	Read only Detector running time

8.4.2 Timers



For quick access from the main screen, configure a function key to **[MAINTENANCE]** (see chapter “Function keys”).

Access: Settings Screen + Menu [Maintenance] [Timers]		Choice - Setting limit ¹⁾
Detector	Read only Detector running time	-
Filament 1	Read only Running time for filament 1	-
	Function to be launched 1. Press [xxx h] to access the reset function. 2. Press [Reset timer] to reset the timer.	-
Filament 2	Read only Running time for filament 2	-
	Function to be launched 1. Press [xxx h] to access the reset function. 2. Press [Reset timer] to reset the timer.	-
Calibrated Leak.	Read only Indicates the month and year of calibration for the calibrated leak used for calibration.	-
Cycles	Read only [xxxx Cy/xxxx Cy]: number of cycles carried out since the last reset compared to the configured cycle interval. When the configured cycle interval is reached, an information message is displayed. Press [xxxx Cy/xxxx Cy] to access additional information (see below 'Additional information about Cycles').	-
Sec. Pump #1	Read only [xxxx h/xxxx h]: running time of the secondary pump 1 since the last reset compared to the configured running time interval. When the configured running time interval is reached, an information message is displayed. Press [xxxx h/xxxx h] to access additional information (see below 'Additional information about Secondary pump #1').	-

1) Initial setting: see chapter "Tree diagram of the Settings menu"

Additional information about Cycles

Access: [xxxx Cy/xxxx Cy] for the 'Cycle' parameter		Choice - Setting limit ¹⁾
Cycles	Read only Percentage of the number of cycles carried out since the last reset compared to the configured cycle interval.	-
Counter	Read only Number of cycles carried out since the last counter reset.	-
Time interval	To be set Number of reference cycles When the number of reference cycles is reached, an information message is displayed.	$1 \cdot 10^{+19} - 1$
Reset counter	Function to be launched Press [Reset counter] to reset the timer.	-

1) Initial setting: see chapter "Tree diagram of the Settings menu"

Additional information about Secondary Pump 1

Access: [xxxx h/xxxx h] for the 'Secondary pump 1' parameter		Choice - Setting limit 1)
Sec. Pump #1	Read only Percentage of running time of the secondary pump 1 since the last reset compared to the configured running time interval.	-
Timer	Read only Running time since the last timer reset	-
Time interval	To be set Reference running time When the configured running time interval is reached, a message is displayed.	0 – 99999
Reset timer	Function to be launched Press [Reset timer] to reset the timer.	-
1) Initial setting: see chapter "Tree diagram of the Settings menu"		

8.4.3 Detector information



For quick access from the main screen, configure a function key to **[Info]** (see chapter "Function keys").

Detector Informations		Return
v.LCD :	4.0.00b (L0232)	
v.CPU :	3.3.97 (L0300)	
v.CELL :	3.3.02 (L0264)	
P Inlet :	3.4E-01 mbar	
Reject Pt :	1.0E-08 mbar.l/s	
Calibration :	Auto [Int.]	
Gas :	Helium	
Filament :	#1 [On]	
Status :	100%	
Last Calib. :	14:41:58	
Next Maintenance :	15780 h	

Reminder: for viewing only in this menu

Access: Settings Screen + Menu [Maintenance] [Detector Information]

Software version .LCD	Control panel firmware information
Software version .CPU	Leak detector firmware information
Software version .CELL	Analyzer cell firmware information
P. Inlet	Inlet pressure
Reject Point	Reject point set for the test method in progress
Calibration	Type of calibration configured
Gas	Tracer gas selected
Filament	Filament used (Status of filament used, detector on)
Status	Filament use rate (100% = new filament)
Last Calib.	Date of last calibration
-	List of activated functions (blank line if none)
Next maintenance	Time before the next maintenance to be performed

8.4.4 Pump Information

Secondary Pump #1

Reminder: for viewing only in this menu

Access: Settings Screen + Menu [Maintenance] [Secondary Pump #1]

Status	Control of the pump by the detector
Rotation	Pump status: Synchro/Down/Fail/Running/Ram up
Speed (rpm)	Pump rotation speed (max 900000 rpm) The pumping speed of the secondary pump can be configured (see chapter “Secondary pump speed”).

► For more information about the secondary pump, press [TMP Information].

TMP Informations		Return
Turbo molecular pump		
Rot. Speed :	1500 Hz / 90000 rpm	
Voltage :	23.63 V	Synchro : Ok
Power :	17 W	TC type : TC 110
Current :	0.75 A	TC Software : 012099
Temperature		
T° Electronic :	48 °C	T° Bottom : 40 °C
T° Bearing :	40 °C	T° Motor : 44 °C
Last maintenance		
1009 h / 16000 h		
Warning		
None		

8.4.5 Event history

The event history records the last 30 events. Beyond 30, the oldest recorded event will be replaced by the most recent, and so on.

Access: Settings Screen + Menu [Maintenance] [Events History]

Events History		Return
Events:1		
1	I313 08/04/13 00:08 Date/Time updat	Export
2	I320 01/01/13 00:02 Int. Pirani Calib	↑
3		↓
4		

1 Exporting the history in .csv format to the SD card
2 Event code

3 Date and time of the event
4 Description of the event

An event can be an error (Exxx), a warning (Wxxx) or an information (Ixxx).

- List of errors and warnings: refer to the RS-232 link operating instructions (see chapter “Applicable documents”).
- Information list

Code	Event	Description
I300	Air inlet	Air inlet
I301	Stp on pollution	Test stops automatically if measured leak rate pollution > Pollution
I302	Rst count RVP	Primary pump counter reset
I303	Rst count TMP1	Secondary pump 1 hour counter reset
I304	Rst count TMP2	Secondary pump 2 hour counter reset (depending on detector model)
I306	Rst count Fil1	Filament 1 hour counter reset
I307	Rst count Fil2	Filament 2 hour counter reset
I308	Rst count cycle	Cycle counter reset
I310	Autocal restart	Automatic start of a new calibration
I313	Date/Time update	Date or time modification
I318	Full param reset	Complete detector parameter reset
I319	Fil change	Filament change (manually or automatically) from Maintenance menu
I320	Int. Pirani Calib.	Automatic internal Pirani gauge calibration
I321	Storage delay	Detector switched off for 15 days (minimum)

8.4.6 Calibration history

The calibration history records the last 20 calibrations made. Beyond 20, the oldest recorded calibration will be replaced by the most recent and so on.

Access: Settings Screen + Menu [Maintenance] [Calibration History]

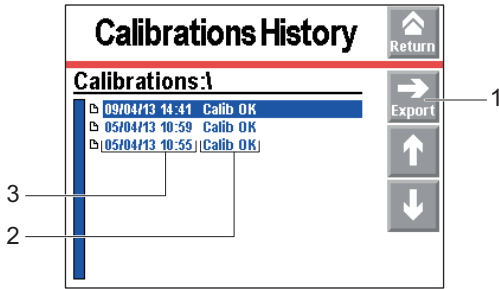

- 1 Exporting the history in .csv format to the SD card
- 2 Calibration result
- 3 Date and time of the calibration

8.4.7 Last maintenance

This function is used to display the 3 last maintenance operations performed on the detector and recorded by the service technician.

- Use the lift to see the 3 last recorded maintenance operations.

Access: Settings Screen + Menu [Maintenance] [Last maintenance]

Date	Date of the maintenance work
Nbr hours	Number of hours of detector operation at the time of maintenance
Inspected by	Maintenance technician who performed the work

8.5 Configuration menu

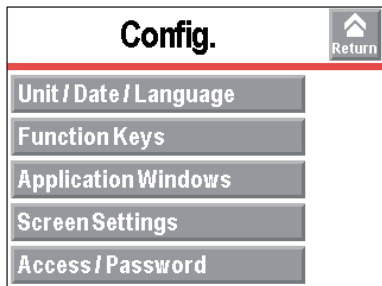

8.5.1 Time – Date – Unit – Language

Access: Settings Screen + Menu [Configuration] [Unit/Date/Language]		Choice - Setting limit ¹⁾
Unit	To be selected ¹⁾ The set points/values set are not automatically converted to the new unit if the unit changes: they must be updated by the user.	mbar · l/s Pa · m ³ /s Torr · l/s atm · cc/s ppm sccm sccs mtorr · l/s
Date	To be set ¹⁾	- Format: Month Day Year (mm/dd/yyyy)

1) No default settings: set by user on switching the detector on for the 1st time

Access: Settings Screen + Menu [Configuration] [Unit/Date/Language]		Choice - Setting limit ¹⁾
Time	To be set ¹⁾ The time is not automatically updated when switching from summer time to winter time and vice versa: it must be updated by the user.	- Format: Hour Minute Second (hh:mm:ss)
Language	To be set ¹⁾	English French German Italian Chinese Japanese Korean Spanish Russian

1) No default settings: set by user on switching the detector on for the 1st time

8.5.2 Function keys

Function keys are used to start/stop a function or to adjust set points.

Using the function keys, a user can be given access to a limited number of functions.

The function keys can be managed using 4 access buttons.

By default, the 8 function keys are allocated and distributed over 2 levels: they can be reallocated by the user.

Up to 4 additional function keys can be added, for a maximum of 12. In this case, a 3rd level will be presented to the user.

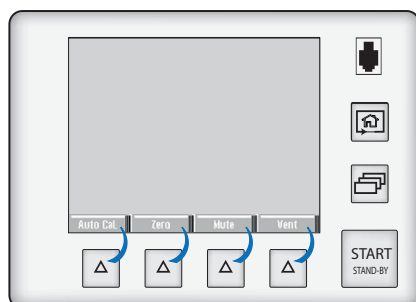

Using the function keys, the user can be given access to a limited number of functions and to use a password to lock unauthorized functions on the “Settings” menu. These are sufficient to manage the detector.

To allow the user to use only the **START/STAND-BY** key, do not allocate a function to the function keys and lock the “Settings” menu.

Allocating function keys

Each function key can be allocated to a function chosen by the user: see the example below.

Access: Settings Screen + Menu [Configuration] [Function keys]

Example: Allocate the ‘Correction’ function to the function key currently attributed to **[Mode]**.

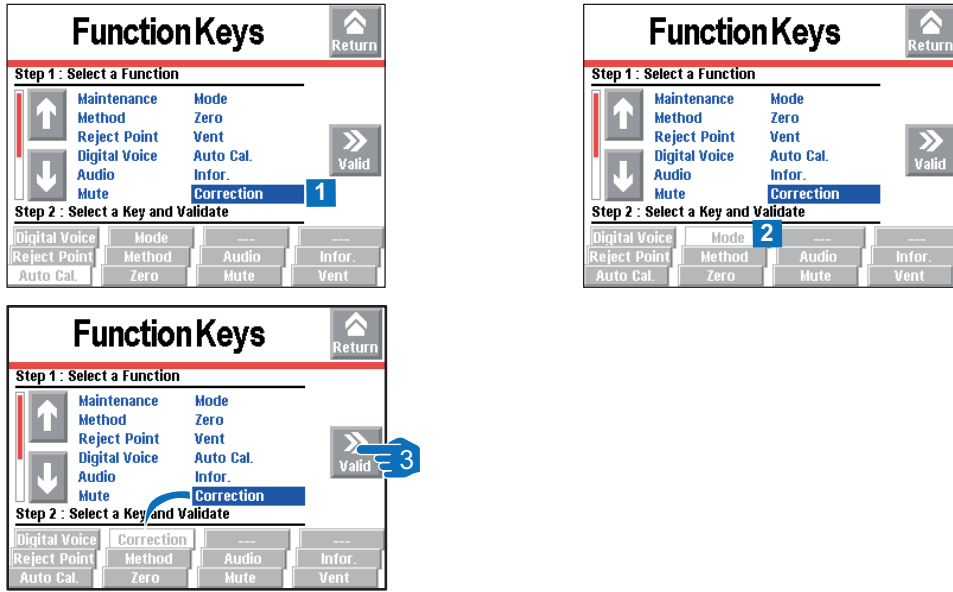

1. Select the 'Correction' function using the arrows.
2. Select the **[Mode]** function key by pressing repeatedly (function key selected if background is white).
3. Validate the selections.
 - The function key previously allocated to **[Mode]** is now assigned to the **[Correction]** function.

8.5.3 Application windows

The user can display/hide one or more screens or change the order in which they scroll in the loop.

By pressing repeatedly on the key , the various application windows displayed in the loop appear (see chapter "Touch screen").

Main screen (Standard) is always displayed in the 1st position.

Access: Settings Screen + Menu [Configuration] [Application windows]

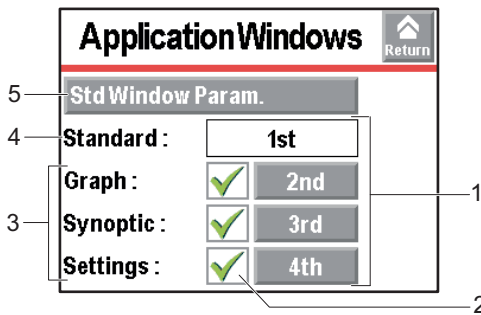

- | | |
|--|--|
| <ol style="list-style-type: none"> 1 Order of screens displayed with the  key 2 Display (✓)/Hide (✗) for application windows 3 Available screens | <ol style="list-style-type: none"> 4 Main screen (standard) always displayed 5 Setting of the main screen (Standard) |
|--|--|

Access: Access: Settings Screen + Menu [Configuration] [Application windows]		Choice - Setting limit ¹⁾
Param. Ecran Std	See below	-
Standard	Read only Main screen display	Enabled by default
	Read only Order in the loop	1 st

1) Initial setting: see chapter "Tree diagram of the Settings menu"

Access: Access: Settings Screen + Menu [Configuration] [Application windows]		Choice - Setting limit ¹⁾
Graph	To be selected Graph screen display	Activate Deactivate
	To be set Order in the loop	2 nd – 4 th
Synoptic	To be selected Vacuum circuit display	Activate Deactivate
	To be set Order in the loop	2 nd – 4 th
Settings	To be selected Settings screen display	Activate Deactivate
	To be set Order in the loop	2 nd – 4 th

1) Initial setting: see chapter "Tree diagram of the Settings menu"

Setting of the main screen (Standard)

This menu is used to enter the control panel settings.

Access: Settings Screen + Menu [Configuration] [Application windows] [Standard Window Parameters]			Choice - Setting limit ¹⁾
Leak Rate Bargraph	Zoom on Set Point	To be selected Zoom on set point is used to display on the bargraph the reject point centered on 2 decades.	No Yes
	Low decade	To be set Low decade of the bargraph.	$1 \cdot 10^{+5} - 1 \cdot 10^{-13}$
	High decade	To be set High decade of the bargraph.	$1 \cdot 10^{+6} - 1 \cdot 10^{-12}$
Stand-By value	To be selected Leak rate display in 'Stand-by' mode	Hide Show	
Inlet Pressure	To be selected Inlet pressure display.	Hide Show	
Extra Pressure	To be selected Display of the cell pressure or of an external gauge. The external gauge (order separately) is a gauge installed on the customer's application, connected to the 37-pin I/O communications interface (option).	Hide Cell Exterior	

1) Initial setting: see chapter "Tree diagram of the Settings menu"

Display/Hide a screen

A screen in the loop can be displayed/hidden.

The main application screen (Standard) is always displayed in the 1st position.

- When a screen is no longer displayed (✘), the overall order is automatically updated (see example 2).
 - When a screen is once again displayed (✔), it is automatically placed in the last position (see example 3).
- ▶ Press the [✘] key on the screen to be displayed.
- ▶ Press the [✔] key on the screen to be hidden.

Modification of the display order

The order of a screen in the loop can be modified.

The main application screen (Standard) is always displayed in the 1st position.

- When the display order for a screen is modified, the overall order is automatically updated (see example 1).

1. Press the order number on the screen for the screen to be modified.
2. Press the **[+]** and **[-]** to choose the new order number.
3. Press **[Valid]**.

Example 1

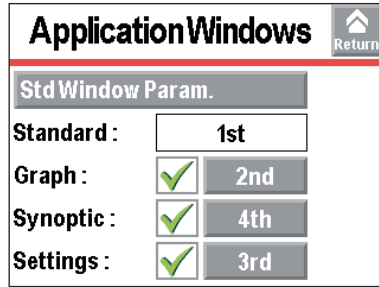

- The Synoptic screen moved from position 3 to 4 in the loop.

Example 2

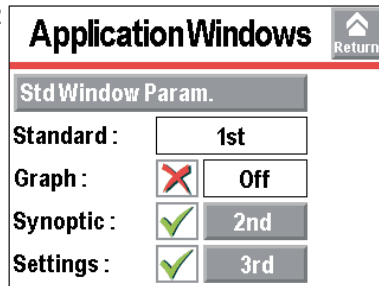

- The Graph screen is hidden and the overall order is updated.

Example 3

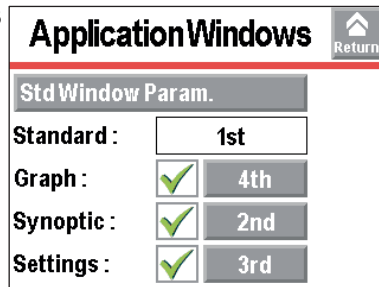

- The Graph screen is once again available in position 4 in the loop.

8.5.4 Screen settings

Access: Access: Settings Screen + Menu [Configuration] [Screen settings]		Choice - Setting limit ¹⁾
Brightness	To be selected	High Low
Contrast	To be set	0 – 100
Panel Off	To be selected The screen is in sleep mode when the back light goes off (black screen). The device appears to be off, but this is not the case! Simply touching the screen reactivates the display.	None 15 min 30 min 1 h 2 h 4 h
Func. Paging	Function available only if a wireless remote control is detected. To be selected When a wireless remote control (accessory) is used, the 'Paging' function makes it possible to easily find the remote if it is located within its field of use with the detector. When the function is activated, the remote control emits a sound signal so it can be located. To stop the sound signal, deselect the Paging function.	No Yes
Reset panel parameters	To be launched Resets control panel parameters	-

1) Initial setting: see chapter "Tree diagram of the Settings menu"

8.5.5 Access – Password

This menu is used to manage the access rights to the various menus and/or screens.

Regardless of the user level, a password is required to access this menu.

The default password is 5555.



The password is not saved in the control panel. If the password is lost, it can be retrieved by using the RS-232 serial link: see the RS-232 serial link operating instructions (see chapter “Applicable documents”).

Access: Settings Screen + Menu [Configuration] [Access/Password] + password		Choice - Setting limit ¹⁾
Password	To be set	0 – 9999
Set points menu access	To be selected	Lock ²⁾
Test menu access	Access to some menus may be authorized or forbidden.	Unlock ³⁾
Spectro menu access	See details below	
Maintenance menu access		
Configuration menu access		
Advanced menu access		
User level	To be selected 3 user levels can be used to restrict the display and access to settings and functions. See details below	Restricted access Medium access Full access
Change password	Function Access See details below	-

1) Initial setting: see chapter “Tree diagram of the Settings menu”

2) Pictograph padlock closed 

3) Pictograph padlock open 

Menu access

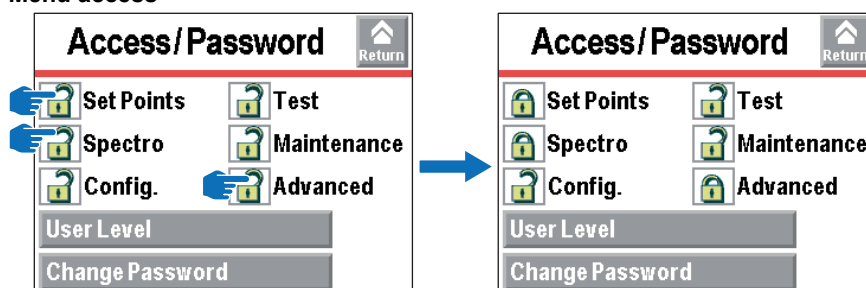

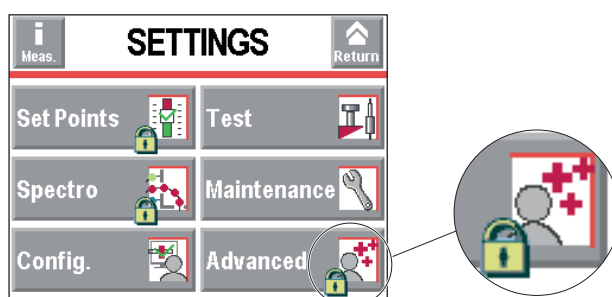

Example 1: locking of Set Points, Spectro and Advanced menus



Example 2: display of locked menus (Set Points, Spectro and Advanced) on the Settings screen

The user can prevent access for one or more menus on the Settings screen by locking them.

To access a locked menu, the user is asked to provide the password.





- ▶ Press the pictograph  to lock the relevant menu (see example 1).
 - On the Settings screen, the locked menus are indicated by a pictograph  (see example 2).
- ▶ Press the pictograph  to unlock the relevant menu.

User level

3 user levels can be used to restrict the display on the control panel and the users' access to settings/ functions:

- restricted access,
- medium access,
- full access.

The rights defined below are those granted **by default** for each user level.

	User level		
	Restricted access	Medium access	Full access
Key 	Disabled No settings can be made without a password	Disabled No settings can be made without a password	Valid
START/STAND-BY button	Disabled Starting a test via communications interface only	Valid	Valid
Pictograph  / 	Disabled	Disabled	Valid
Function keys	Masked	2 function keys available: <ul style="list-style-type: none"> • [Basic Param.] • [Infor] 	Displayed
Display for inlet pressure and cell pressure	Masked	Masked	Displayed
Display of measured leak rate and reject point displayed only in test	Display only in test	Display only in test	Yes
Access to settings menus	No No setting possible without a password (temporary access allowed)	No No setting possible without a password (temporary access allowed) Temporary access: <ol style="list-style-type: none"> 1. Press and hold the  button until the Settings screen is displayed with all of the locked menus. 2. Press on the menu to be opened. 3. Enter the current password. 4. Validate. 5. Configure the desired settings. 	Yes



Using the RC 10 remote control (accessory)
There is no user-level impact on the remote control. All of the remote control functions are valid.

Restricted access display

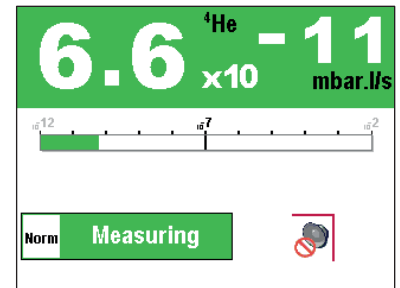
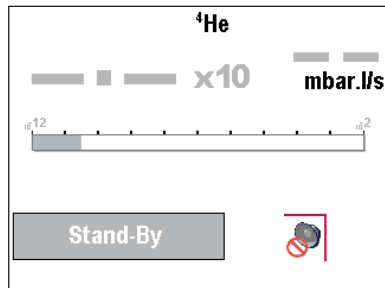

Medium access display

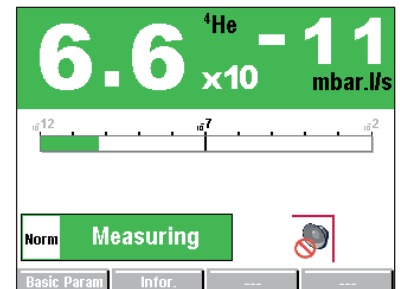
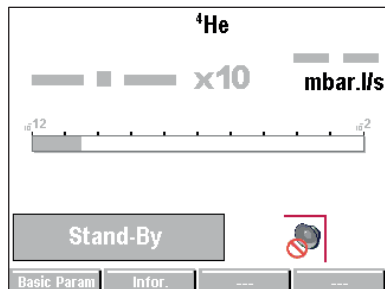

2 function keys available

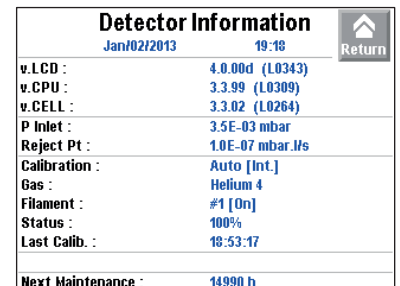
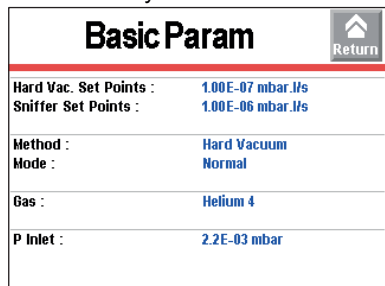

Full access display

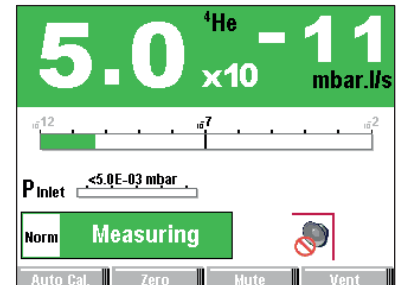
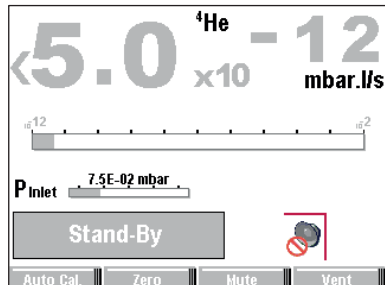

Access level change

For a user with restricted or medium access.

1. Press and hold the  button until the Settings screen is displayed with all of the locked menus.
2. Press the **Settings Screen + Menu [Configuration]**.
3. Enter the current password.
4. Validate.
5. Press **[Access/Password]**.
6. Enter the current password.
7. Validate.
8. Press **[User level]**.
9. Change the access level.
10. Validate.

For a user with full access

1. **Access: Settings Screen + Menu [Configuration] [Access/Password]**
2. Enter the current password and validate.
3. Press **[User level]**.
4. Change the access level.
5. Validate.

Change the password

Access: Settings Screen + Menu [Configuration] [Access/Password]

1. Enter password.
2. Validate.
3. Press **[Change Password]**.
4. Enter the new password.
5. Validate.

8.6 Advanced menu

The Advanced menu is reserved for leak detection experts or for a particular product configuration.

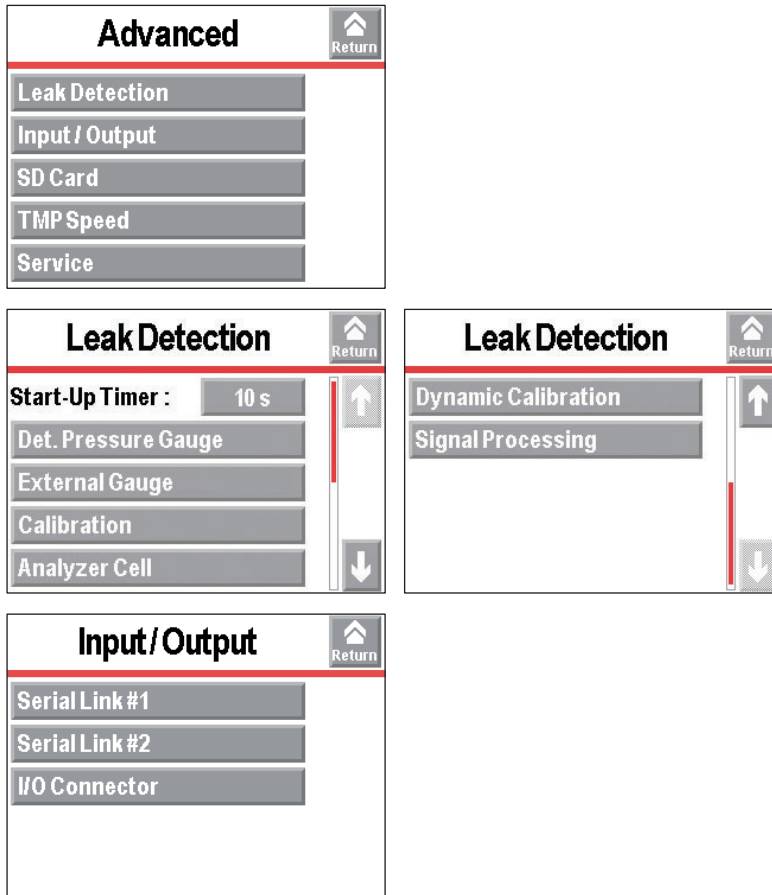

8.6.1 Leak Detection: Start Up timer

The start-up timer prevents the leak detector from being used for a pre-determined duration after it has been switched on. This means measurements cannot be made until the leak detector is thermally stabilized, or while traces of tracer gas remain in the detector.

Access: Settings Screen + Menu [Advanced] [Leak Detection] [Start Up Timer]		Choice - Setting limit ¹⁾
Start Up Timer	To be set	0 – 1h

1) Initial setting: see chapter "Tree diagram of the Settings menu"

8.6.2 Leak Detection: Detector pressure gauge

This function is used to manage the leak detector using a pressure gauge.

The gauge is connected directly to the electronic module.

Location of the connector: see chapter "Connection interface" (**PRESSURE** connector)

Setting

Access: Settings Screen + Menu [Advanced] [Leak detection] [Detector pressure gauge]		Choice - Setting limit ¹⁾
Gauge	To be selected There is no automatic recognition of the gauge upon connection.	TPR/PCR Linear
Full scale (mbar)	This setting only relates to linear gauges. To be set Set the operating range for the gauge: value indicated on the gauge.	0.1 – 50,000

1) Initial setting: see chapter "Tree diagram of the Settings menu"

Possible gauges

The gauge should be ordered separately.

Gauge type		Type of gauge set	Gauge model
Linear gauge	Capacitive	Linear	CMRxxx
	Piezo	Linear	APRxxx
Logarithmic gauge	Pirani	TPR/PCR	TPRxxx
	Capacitive Pirani	TPR/PCR	PCRxxx

8.6.3 Leak Detection: External gauge

This function enables the leak detector to be controlled by an external gauge and/or recover the pressure of the detector.

Location of the connector: see chapter "Connection interface" (**INPUT/OUTPUT** connector)

Prerequisite

- ▶ Detector equipped with '37-pin I/O communication interface' (option/accessory).

Use of an external gauge to control the detector

Setting: Inlet pressure source: 'external'

Access: Settings Screen + Menu [Advanced] [Leak detection] [External Gauge]		Choice - Setting limit ¹⁾
Gauge	Automatic recognition of the type of external gauge connected.	None TPR/PCR Linear
Ext. pres. (mbar)	Read only Indicates the pressure measured by the external gauge.	-
Inlet press. source	To be set <ul style="list-style-type: none"> • Internal: pressure gauge of the detector connected directly to the electronic module • External: customer system external gauge connected to the electronics module on the 37-pin I/O connector 	Internal External
Full scale (mbar)	This setting only relates to linear gauges. To be set Set the operating range for the gauge: value indicated on the gauge	0.1 – 50,000

1) Initial setting: see chapter "Tree diagram of the Settings menu"

Use of the external gauge to recover the pressure of the detector:

Setting: Assign an analog output of the 37-pin I/O communication interface connector to the external pressure (see communication interface operating instructions).

Possible gauges

The gauge should be ordered separately.

The use of a specific cable is required (see chapter "Accessories").



The cables (accessories) are only prepared for the connection of a gauge.
The user can modify the wiring to control other I/Os (wiring modification at the customer's expense).

Gauge type		Type of gauge set	Gauge model
Linear gauge	Capacitive	Linear	CMRxxx
	Piezo	Linear	APRxxx
Logarithmic gauge	Pirani	TPR/PCR	TPRxxx
	Capacitive Pirani	TPR/PCR	PCRxxx

8.6.4 Leak Detection: Calibration

Calibration helps check that the leak detector is correctly adjusted to detect the tracer gas selected and display the correct leak rate (see chapter “Calibration”).

By default, internal leak is selected to allow for a rapid calibration of the leak detector. It is also possible to calibrate the leak detector with an external leak (see chapter “Calibration”).

The ‘Internal calibration’ is an option/accessory for the ASI 35.

- Detector not equipped with ‘Internal Calibration’
 - The detector can be calibrated with an external calibrated leak.
 - By default, calibration is set to ‘Operator’ and ‘External’ leak is selected.
- Detector to be equipped with ‘Internal Calibration’
 - By default, calibration is set to ‘Operator’ and ‘Internal’ leak is selected.



Detector calibration

20 minutes after switching it on, the detector suggests that the user perform a calibration. For correct use of the detector and to optimize the accuracy of the measurement, **this calibration must be performed.**

It is recommended to perform a calibration:

- at least once a day,
- for intense operation: start calibration at the beginning of each work session (e.g. work in shifts, every 8 hours),
- if it is uncertain whether the detector is working properly.

Access: Settings Screen + Menu [Advanced] [Leak detection] [Calibration]			Choice - Setting limit ¹⁾	
Calibration	To be selected <ul style="list-style-type: none"> • Operator Calibration initiated by the user pressing the [AUTOCAL] function key. If the calibration is not begun within 20 minutes of switching the detector on, the message ‘Detector ready for calibration’ appears to prompt the user to start a calibration. <div style="border: 1px solid black; padding: 5px; width: fit-content; margin: 5px 0;"> <p style="text-align: center; margin: 0;">Detector ready for calibration.</p> <p style="margin: 0;"> Auto Cal. Return </p> </div> <ul style="list-style-type: none"> • Manual Calibration starts manually. <p>Operation reserved for service centers and experts only.</p>		Operator Manual	
Calibration checking	Checking	To be selected See details below <ul style="list-style-type: none"> • Operator: calibration check not enabled • Automatic: calibration check enabled 	Operator Automatic	
	Frequency	Cycles	To be set Set point (cycles) initiating calibration check. Calibration check begins when either the ‘Cycles’ or the ‘Time’ set point is reached.	0 – 9999
		Hours	To be set Set point (time) initiating calibration check. Calibration check begins when either the ‘Cycles’ or the ‘Time’ set point is reached.	0 – 9999

1) Initial setting: see chapter “Tree diagram of the Settings menu”

‘Calibration checking’ details



For quick access from the main screen, configure a function key to **[Calibration check]** (see chapter “Function keys”).



At any time, the user can start a calibration check: with the leak detector in 'Stand-by' mode, press the **[AUTOCAL]** function key twice within 5 seconds.

The calibration check enables the operator to save up to 50% time compared to an internal calibration.

The calibration check does not modify any calibration parameters.

The calibration control is enabled if calibration is set to 'operator.'

The leak detector compares the measured leak rate of the internal calibrated leak with the set leak rate of the internal calibrated leak:

- If the ratio is within the limits allowed, the leak detector is properly calibrated.
- If the ratio is out of limits, a message appears suggesting that a full calibration of the leak detector be started.

Calibration check with external calibrated leak: the test mode selected must be consistent with the detector connection.

The mode must be identical to the port used to connect the detector (example: connection to the Normal port -> 'Normal' mode selected).

8.6.5 Leak Detection: Analyzer cell

This function is used to view information on the leak detector.

Access: Settings Screen + Menu [Advanced] [Leak detection] [Analyzer cell]		Choice - Setting limit ¹⁾
Filament Selected	To be selected Filament used for the measurement (2 filaments in the analyzer cell).	1 2
Filament	To be selected Activation (ON) or deactivation (OFF) of the filament in use for the measurement.	Off On
Triode pressure Electric Zero Target value Acceleration Voltage (V) Emission (mA) Sensit. Coeff.	Read only Parameters for manual calibration. This type of calibration is reserved for leak detection experts.	-
Calibration valve	To be selected Current state of calibration valve. Used to open/close manually the calibration valve. Do not forget to close the valve again. Manual calibration is reserved for experts only.	Off On
Internal Temperature (°C)	Read only Indicates the temperature at the detector's internal calibrated leak.	-

1) Initial setting: see chapter "Tree diagram of the Settings menu"



- When switched on, the leak detector uses the filament that was selected when the detector was shut down.
- The leak detector switches automatically from one filament to the other if the selected filament currently in use becomes defective.
- It is not necessary to turn off the filament in Stand-by mode to save it.
- Do not switch off the filament except for carrying out manual calibration. **Manual calibration is reserved for experts only.**

8.6.6 Leak Detection: Dynamic calibration

This function allows predictive adjustment of the leak rate for repetitive tests where the test time has to be optimized.

The adjustment is made via the RS -232 serial link or logic inputs.



This function provides an adjustment and should not be confused with the correction coefficient.
 This coefficient complements the correction coefficient.

Access: Settings Screen + Menu [Advanced] [Leak detection] [Dynamic calibration]		Choice - Setting limit ¹⁾
Active	To be enabled	Yes No
Value	To be set Target value to reach (leak rate value of the system to calibrate)	$1 \cdot 10^{+19}$ - $1 \cdot 10^{-19}$
Coefficient	Read only Coefficient value calculated during dynamic calibration (coefficient applied if dynamic calibration is activated)	-

1) Initial setting: see chapter "Tree diagram of the Settings menu"

Prerequisites

- ▶ Perform leak detector calibration.
- ▶ Enable the correction factor.
- ▶ Set the correction factor.
- ▶ Activate the dynamic calibration.
- ▶ Set the target value.
- ▶ Assign the logic inputs (see the communication interface operating instructions) or connect the RS-232 serial link.

	Logic input	RS-232 command
Start/stop the dynamic calibration coefficient calculation	Dynamic cal.	Start: =CDC Stop: =CDS
Start/Stop Test	HV test	Start: =CYE Stop: =CYD
Start/Stop Memo function	He memo	Start: =MEF Stop: =MER

Setting procedure for one test

1. Implement the preliminary conditions.
2. Activate the dynamic calibration coefficient calculation.
3. Start a test.
4. Activate the Memo function (logic input or RS-232 serial link).
5. The new coefficient is automatically calculated and saved.
 The calculated coefficient corresponds to the following ratio:

$$\text{Coefficient} = [\text{target value}] / [\text{value of the leak rate displayed to adjust}]$$
 The calculated coefficient must be between 0.5 and 3 inclusive. If not, an error message is displayed.
6. Stop the test.
7. Disable the Memo function (logic input or RS-232 serial link).
8. Stop the dynamic calibration coefficient calculation.

Example

- Target value = $1.0 \cdot 10^{-7}$
- Value of the leak rate displayed to adjust: $5.0 \cdot 10^{-8}$
- Coefficient calculation

$$\text{Coefficient} = [1.0 \cdot 10^{-7}] / [5.0 \cdot 10^{-8}] = 2$$
 As 2 is between 0.5 and 3, the coefficient is correct.

Setting procedure for several tests

Several tests can be run to calculate the dynamic calibration coefficient. This allows the coefficient value to be fine-tuned.

1. Implement the preliminary conditions.
2. Activate the dynamic calibration coefficient calculation.
3. Start the 1st test.
4. Activate the Memo function (logic input or RS-232 serial link).
5. The new coefficient is automatically calculated and saved.

The 1st coefficient calculated for the 1st test corresponds to the following ratio:

$$1^{\text{st}} \text{ coefficient (Coef 1)} = [\text{target value}] / [\text{leak rate value of the } 1^{\text{st}} \text{ test}]$$

The calculated coefficient must be between 0.5 and 3 inclusive. If not, an error message is displayed.

6. Stop the test.
7. Disable the Memo function (logic input or RS-232 serial link).
8. Repeat all of the last 4 operations n times:
 - Start a test.
 - Enable the Memo function.
 - Stop the test.
 - Disable the Memo function.

The calculated and saved coefficient is readjusted after each test, as in:

$$\text{Coefficient} = [\text{Coef 1} + \text{Coef 2} + \dots + \text{Coef n}] / [n]$$

9. Stop the dynamic calibration coefficient calculation.



The coefficient will continue to be readjusted after each test until the dynamic calibration coefficient calculation is stopped.

8.6.7 Leak Detection: Signal processing

This menu is used to modify the signal processing.

Access: Settings Screen + Menu [Advanced] [Leak detection] [Signal processing]		Choice - Setting limit ¹⁾
Signal processing	To be selected <ul style="list-style-type: none"> • Stable+: optimized signal processing, preferred parameter. • Fast: no signal processing, use reserved for experts only • Stable: compromise between the 2 treatments 'Stable+' and 'Fast'. Stable+: optimized signal processing, preferred parameter. Fast signal processing improving the reactivity of the tracer gas signal.	Stable Stable+ Fast

1) Initial setting: see chapter "Tree diagram of the Settings menu"

8.6.8 Input/Output: Serial link 1 and Serial link 2

The parameters displayed depend on the choices made.

Access: Settings Screen + Menu [Advanced] [Input/Output] then [Serial link 1] or [Serial link 2]			Choice - Setting limit ¹⁾
Type	To be selected Type of connection Refer to the operating instructions for the option/accessory used.		Serial ²⁾ USB ⁴⁾ Network ^{3) 4)} Not used ³⁾
Parameters	Mode	To be selected Connection mode Refer to the operating instructions for the option/accessory used.	Exhaustive list: availability depending on link used and communication interface installed Basic Spreadsheet Advanced Export Data RC 500 WL RC 500 HLT 5xx HLT 2xx Ext. module ²⁾
	Handshake	To be selected	None XON XOFF
	Power Pin 9	Read only	5 V

- 1) Initial setting: see chapter "Tree diagram of the Settings menu"
- 2) Serial link 1 only
- 3) Serial link 2 only
- 4) 37-pin I/O communication interface option/accessory only

8.6.9 Input/Output: I/O connector

Access: Menu [Advanced] [Input/Output] [I/O connector]

All leak detectors are equipped with an RS-232 serial link.

The detector is equipped, depending on its ordered configuration:

- with a 37-pin D-Sub I/O communication interface (with USB)
- with an Ethernet and a 37-pin D-Sub I/O communication interface (with USB)
- with a 15-pin D-Sub I/O communication interface
- with a 15-pin Profibus D-Sub I/O communication interface module
- with a 15-pin Profinet D-Sub I/O communication interface
- with an EtherCAT and a 15-pin D-Sub I/O communication interface
- with an EtherNet/IP and a 15-pin D-Sub I/O communication interface

Refer to the operating instructions for the communication interface (see chapter "Applicable documents").

8.6.10 Secondary Pump Speed

This function manages the turbomolecular pump.

Access: Settings Screen + Menu [Advanced] [Secondary pump speed]		Choice - Setting limit ¹⁾
Current (rpm/Hz)	Read only Current pumping speed of the turbomolecular pump	-
Target (rpm/Hz)	To be set Pumping speed of the turbomolecular pump: <ul style="list-style-type: none"> • 1500 Hz/90,000 min⁻¹: standard configuration for use of the detector within the standard temperature range • 1000 Hz/60,000 min⁻¹: configuration recommended if the detector is used in a hotter atmosphere (a few degrees above the maximum use temperature). At this speed, the performances of the detector are variable. 	1000 1500 60,000 90,000

1) Initial setting: see chapter "Tree diagram of the Settings menu"



The coefficient will continue to be readjusted after each test until the dynamic calibration coefficient calculation is stopped.

8.6.11 SD Card menu



Creating a library of the configurations for each application is recommended if the detector is used for more than one application.

Any SD card on the market can be used except cards with High Capacity technology, regardless of the memory size. Before use, make sure that the SD card is not locked (message "SD card not detected" displayed).

Access: Settings Screen + Menu [Advanced] [SD Card]

Load Parameters De- tector	Function to be launched Loading of the saved parameters (configuration) on the control panel SD card. Prerequisites: detector power on and in 'Stand-by' mode. After loading, the following parameters should be configured by the user: language, serial link, date, time, temperature unit and pressure unit.
Save Parameters De- tector	Function to be launched Save the leak detector parameters (configuration) on the control panel SD card. Prerequisites: detector power on and in "Stand-by" mode. All of the detector's parameters are saved except for the following: language, serial link, date, time, temperature unit and pressure unit.
Visualize * .BMP	Function to be launched View the saved ".bmp" files.

8.6.12 Service

Access to the Service menu is password protected.
Reserved for the Service Centers.

9 Maintenance/Replacement

Maintenance intervals and responsibilities

The detector maintenance operations are described in the Maintenance instructions for the detector.

The manual specifies:

- maintenance intervals,
- maintenance instructions,
- shutting the product down,
- tools and spare parts.

10 Service solutions by Pfeiffer Vacuum

We offer first-class service

High vacuum component service life, in combination with low downtime, are clear expectations that you place on us. We meet your needs with efficient products and outstanding service.

We are always focused on perfecting our core competence – servicing of vacuum components. Once you have purchased a product from Pfeiffer Vacuum, our service is far from over. This is often exactly where service begins. Obviously, in proven Pfeiffer Vacuum quality.

Our professional sales and service employees are available to provide you with reliable assistance, worldwide. Pfeiffer Vacuum offers an entire range of services, from [original replacement parts](#) to [service contracts](#).

Make use of Pfeiffer Vacuum service

Whether preventive, on-site service carried out by our field service, fast replacement with mint condition replacement products, or repair carried out in a [Service Center](#) near you – you have various options for maintaining your equipment availability. You can find more detailed information and addresses on our homepage, in the [Pfeiffer Vacuum Service](#) section.

You can obtain advice on the optimal solution for you, from your [Pfeiffer Vacuum representative](#).

For fast and smooth service process handling, we recommend the following:



1. Download the up-to-date form templates.
 - [Explanations of service requests](#)
 - [Service requests](#)
 - [Contamination declaration](#)



- a) Remove and store all accessories (all external parts, such as valves, protective screens, etc.).
 - b) If necessary, drain operating fluid/lubricant.
 - c) If necessary, drain coolant.
2. Complete the service request and contamination declaration.



3. Send the forms by email, fax, or post to your local [Service Center](#).



4. You will receive an acknowledgment from Pfeiffer Vacuum.

PFEIFFER VACUUM

Submission of contaminated products

No microbiological, explosive, or radiologically contaminated products will be accepted. Where products are contaminated, or the contamination declaration is missing, Pfeiffer Vacuum will contact you before starting service work. Depending on the product and degree of pollution, **additional decontamination costs** may be incurred.

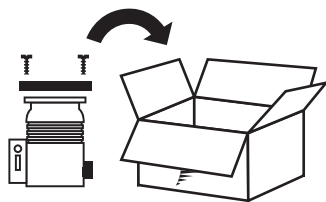

5. Prepare the product for transport in accordance with the provisions in the contamination declaration.
 - a) Neutralize the product with nitrogen or dry air.
 - b) Seal all openings with blind flanges, so that they are airtight.
 - c) Shrink-wrap the product in suitable protective foil.
 - d) Package the product in suitable, stable transport containers only.
 - e) Maintain applicable transport conditions.

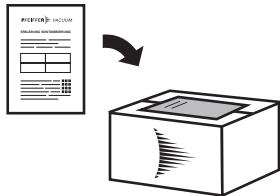

6. Attach the contamination declaration to the **outside** of the packaging.

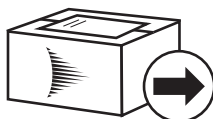

7. Now send your product to your local Service Center.

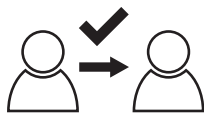

8. You will receive an acknowledgment/quotation, from Pfeiffer Vacuum.

PFEIFFER VACUUM

Our sales and delivery conditions and repair and maintenance conditions for vacuum devices and components apply to all service orders.

11 Accessories

Designation		Part Number
Standard sniffer probe		Refer to Pfeiffer Vacuum catalogue
Standard sniffer probe extension (10 m)		090216
Remote control RC 10		124193
Smart Sniffer Probe (3 m)		BG 449 207 -T
Smart Sniffer Probe (5 m)		BG 449 208 -T
Smart Sniffer Probe (10 m)		BG 449 209 -T
Helium 4 calibrated leak		Refer to Pfeiffer Vacuum catalogue
Adaptor for external calibrated leak	DN 25 ISO-KF	127904
	DN 16 ISO-KF	127905
Spray gun (Elite)		109951
Spray gun (Standard)		112535
Remote control RC 10		124193
ASI 20 MD module		123352
2xxx module		123353
3xxx module		123354
CMR / APR / TPR / PCR xxx gauge		Refer to Pfeiffer Vacuum catalogue
Cable for CMR / APR / TPR / PCR xxx gauge ¹⁾		Refer to Pfeiffer Vacuum catalogue
3 m cable for CMR / APR / TPR / PCR xxx gauge ²⁾		A333746
10 m cable for CMR / APR / TPR / PCR xxx gauge ²⁾		A333747
Industrial control panel ³⁾		122447S
Sniffing Kit		123529
Internal calibration kit		123530

1) Cable for connecting the external gauge (see chapter "Leak Detection: External gauge")

2) Cable for connecting the detector pressure gauge (see chapter "Leak Detection: Detector pressure gauge")

3) Panel delivered without cable: to be ordered separately

12 Technical data and dimensions

12.1 General

Databases of technical characteristics of Pfeiffer Vacuum leak detectors:

- Technical characteristics according to:
 - AVS 2.3: Procedure for calibrating gas analyzers of the mass spectrometer type
 - EN 1518: Non-destructive testing. Leak testing. Characterization of mass spectrometer leak detectors
 - ISO 3530: Methods of calibrating leak detectors of the mass-spectrometer-type used in the field of vacuum technology
- Standard conditions: 20 °C, 5 ppm ⁴He ambient conditions, degassed detector
- Zero function or background suppression enabled
- Acoustic pressure level: distance in relation to the detector 1 m.
- Primary pump connected to the detector: RVP 2005

12.2 Technical characteristics

Parameters	ASI 35
Start-up time (20°C) without calibration	≈ 3 mn
Max. power consumption	300 W
Operating temperature	10–45°C
Detectable gases	⁴ He, ³ He, H ₂
Minimum detectable leak rate for ⁴ He	See tables below
Interface	RS-232, USB, Ethernet, Profibus, Profinet, EtherCAT, Ethernet/IP, 15-pin I/O, 37-pin I/O
Power supply	90-240 V~, 50/60 Hz

Minimum detectable leak rate for ⁴He - Hard vacuum test

Minimum detectable leak rate measured under the following conditions:

- stable operating temperatures within the authorized range,
- product switched on for at least 2 hours
- RVP2005 as backing pumping.

Secondary pump speed	Detection module connection	Minimum detectable leak rate for ⁴ He Pa m ³ /s (mbar l/s)	Crossover pressure Pa (mbar)	Flow He (l/s)
1500 Hz	Gross Leak mode port	3.5 · 10 ⁻⁹ (3.5 · 10 ⁻⁸)	1800 (18)	- ¹⁾
	Normal mode port	1.0 · 10 ⁻¹¹ (1.0 · 10 ⁻¹⁰)	100 (1)	1.8
	High Sensitivity mode port	< 5.0 · 10 ⁻¹³ (< 5.0 · 10 ⁻¹²)	20 (0.2)	6
1000 Hz	Gross Leak mode port	< 5.0 · 10 ⁻¹⁰ (< 5.0 · 10 ⁻⁹)	1800 (18)	- ¹⁾
	Normal mode port	6.0 · 10 ⁻¹² (6.0 · 10 ⁻¹¹)	350 (3.5)	1.5
	High Sensitivity mode port	< 5.0 · 10 ⁻¹³ (< 5.0 · 10 ⁻¹²)	10 (0.1)	5

1) Depending on the primary pump used

Minimum detectable leak rate for ⁴He - Sniffing test (option/accessory)

Minimum detectable leak rate measured under the following conditions:

- stable operating temperatures within the authorized range,
- product switched on for at least 2 hours
- RVP2005 as backing pumping.

Secondary pump speed	Minimum detectable leak rate for ⁴ He with Smart probe Pa m ³ /s (mbar l/s)	Maximum flow with RVP 2005 (sccm)
1500 Hz	$1.5 \cdot 10^{-9}$ ($1.5 \cdot 10^{-8}$)	800
1000 Hz	$1 \cdot 10^{-9}$ ($1 \cdot 10^{-8}$)	300

Environmental conditions

Storage temperature	-25 – +70°C
Maximum air humidity	80% up to 31°C, descending to 50% on a straight-line basis up to 45°C

Weight

Detection module	14.5 kg
Electronic module	4.5 kg
Industrial control panel (option/accessory)	1.3 kg

12.3 Units of pressure

Unit	mbar	bar	Pa	hPa	kPa	Torr / mm Hg
mbar	1	$1 \cdot 10^{-3}$	100	1	0.1	0.75
bar	1000	1	$1 \cdot 10^5$	1000	100	750
Pa	0.01	$1 \cdot 10^{-5}$	1	0.01	$1 \cdot 10^{-3}$	$7.5 \cdot 10^{-3}$
hPa	1	$1 \cdot 10^{-3}$	100	1	0.1	0.75
kPa	10	0.01	1000	10	1	7.5
Torr / mm Hg	1.33	$1.33 \cdot 10^{-3}$	133.32	1.33	0.133	1

$$1 \text{ Pa} = 1 \text{ N/m}^2$$

Tbl. 1: Units of pressure and their conversion

12.4 Gas throughputs

Unit	mbar l/s	Pa m ³ /s	sccm	Torr l/s	atm cm ³ /s
mbar l/s	1	0.1	59.2	0.75	0.987
Pa m ³ /s	10	1	592	7.5	9.87
sccm	$1.69 \cdot 10^{-2}$	$1.69 \cdot 10^{-3}$	1	$1.27 \cdot 10^{-2}$	$1.67 \cdot 10^{-2}$
Torr l/s	1.33	0.133	78.9	1	1.32
atm cm ³ /s	1.01	0.101	59.8	0.76	1

Tbl. 2: Gas throughputs and their conversion

12.5 Dimensions

Detection module (mm)

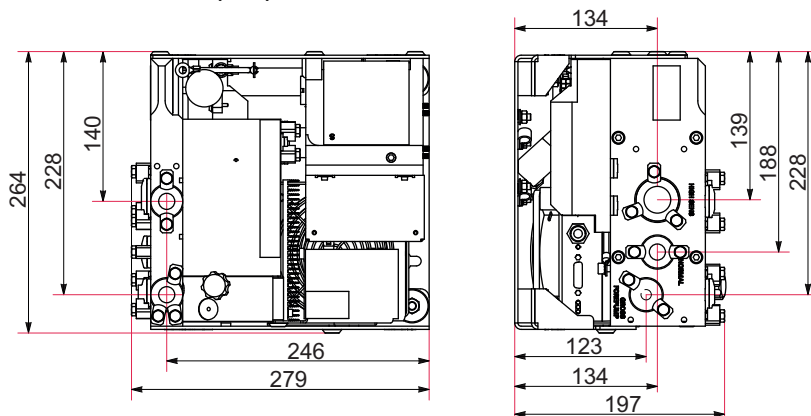

Electronic module (mm)

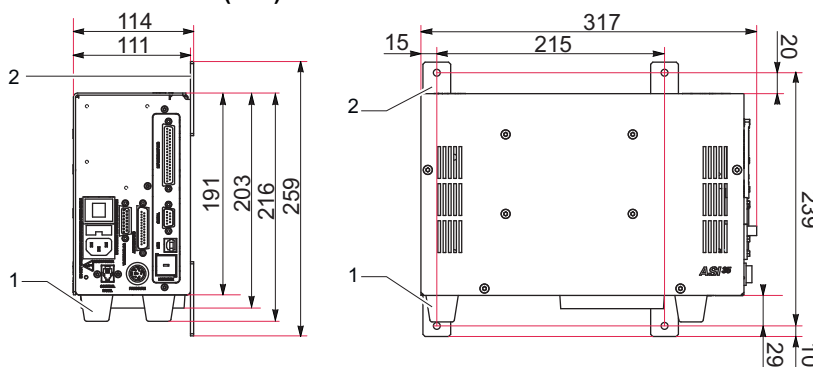

1 Removable feet (see chapter "Attachment of the electronic module")

2 Removable fixing brackets, not mounted but delivered with the detector (see chapter "Attachment of the electronic module")

Industrial control panel (mm) (option/accessory)

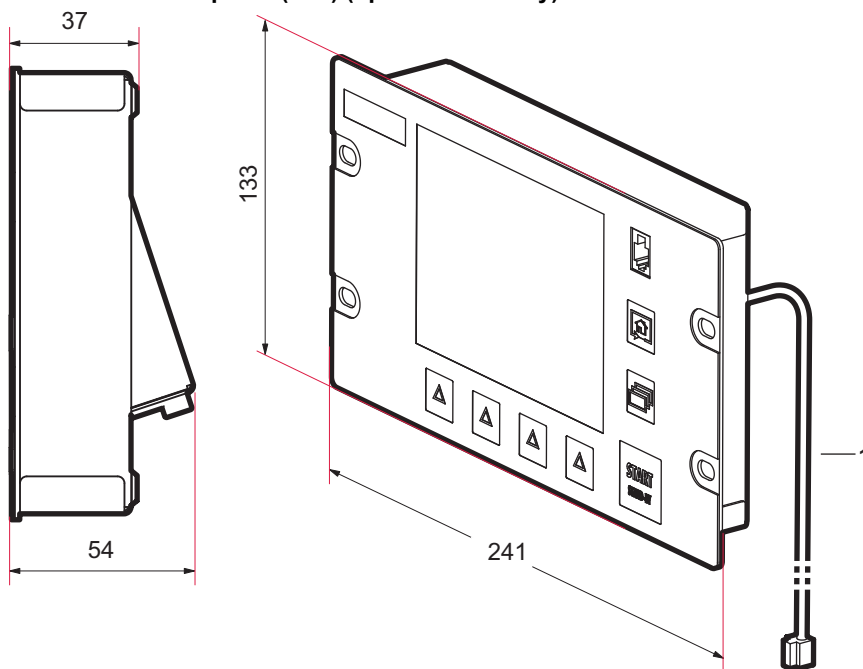

1 The cable is not included with the industrial control panel (accessory)

13 Annex

13.1 ASI 20 MD / ASI 30 / ASI35 specific features

Electronic module		
ASI 20 MD	ASI 30	ASI 35
1 low voltage module and 1 high voltage module	1 multi-voltage single module	
Front side with 1 rack 19" format	A plate used to mount the electronic module in a ½ rack format, is delivered with the detector.	
3 connectors to control fixed and not modifiable I/O	1 37-pin D-Sub connector to manage the I/O: <ul style="list-style-type: none"> configuration of the 37-pin D-Sub connector I/O use of an 'interface extension kit' to provide the facilities of 3 ASI 20 MD connectors 	Use of an 'interface extension kit' to provide the facilities of 3 ASI 20 MD connectors: <ul style="list-style-type: none"> configuration of the 37-pin D-Sub connector I/O use of one of the 3 ASI20MD/ 2xxx/3xxx (accessory) modules to provide the facilities of the 3 ASI 20 MD connectors or other product.
	2 connectors to configure: <ul style="list-style-type: none"> either the control panel or the remote control 	1 connector for the control panel

Detection module		
ASI 20 MD	ASI 30	ASI 35
4 attachment points on the bracket or the sole of the module: different between-centers dimensions for each product		
Flexible size for integration <ul style="list-style-type: none"> rotation of the detection module and the analyzer cell position of the analyzer cell and the calibrated leak 	Compact, non-modular module	
Calibrated leak as standard	Calibrated leak as an option/accessory	

Industrial control panel		
ASI 20 MD	ASI 30	ASI 35
Standard supply	½ rack format The drawing of a plate used to mount the industrial control panel in a 1 rack format is available in the operating instructions USB (manufacture of this plate is at the customer's expense).	
Control panel with loudspeaker	No loudspeaker: an external loudspeaker, headphone or buzzer can be connected (order separately)	
Specific control panel	Identical industrial control panel for ASI 30/35.	

Maximum cross over thresholds on test		
ASI 20 MD	ASI 30	ASI 35
2 test modes: Gross Leak and Normal		3 test modes: Gross Leak, Normal and High Sensitivity
Gross Leak mode: 20 hPa	Gross Leak mode: 40 hPa	Variable thresholds depending on the frequency of the secondary pump (see chapter "Connection of the installation to be tested")
Normal mode: 2 hPa	Normal mode: 4 hPa	

Option/Accessory		
ASI 20 MD	ASI 30	ASI 35
ASI 20 MD/ASI 30 ¹⁾ sniffing kit		ASI 35 ¹⁾ sniffing kit
RVP 2005 IS ¹⁾		Standard primary pump ¹⁾
Measurement kit with PI3C gauge ¹⁾	No measurement kit TPR/PCRxxx gauge ¹⁾ Compatibility with PI3C gauge	No measurement kit CMR/APR/TPR/PCRxxx gauge ¹⁾ No compatibility with PI3C gauge
-	1 ASI 20 MD type I/O module ¹⁾	3 ASI20MD/2xxx/3xxx type I/O modules ¹⁾
No Bluetooth	Bluetooth ¹⁾²⁾	No Bluetooth
No 37-pin I/O board	37-pin I/O board with/without Wi-Fi or Ethernet ¹⁾²⁾	37-pin I/O board with/without Ethernet ²⁾
No Profibus	Profibus ¹⁾²⁾	Profibus ²⁾
No Profinet	No Profinet	Profinet ²⁾
No Profinet/IP	No Profinet/IP	Profinet/IP ²⁾³⁾
No EtherCAT	No EtherCAT	EtherCAT ²⁾

1) Accessory
2) Option
3) ASI 35 V2 only

13.2 Tree diagram of the Settings menu

Next tables indicate the default settings for the leak detector.

When the leak detector is switched off, values and parameters are saved for the next start-up.

Default settings: 'Set Points' menu

Access: Settings Screen + Menu [Set Points]		Choice - Setting limit
Audio	Status	Enabled ¹⁾ Disabled
	Setting (If enabled)	1 – 9 3 ¹⁾
Digital Voice	Status	Enabled ¹⁾ Disabled
	Setting (If enabled)	1 – 9 4 ¹⁾
Pollution	Status	Enabled Disabled ¹⁾
	Setting (If enabled)	$1 \cdot 10^{+19}$ – $1 \cdot 10^{-19}$ $1 \cdot 10^{-05}$ ¹⁾
Backgnd Max	Status	Enabled Disabled ¹⁾
	Setting (If enabled)	$1 \cdot 10^{+19}$ – $1 \cdot 10^{-19}$ $1 \cdot 10^{-08}$ ¹⁾

1) Default setting

2) Function available with 37-pin I/O communication interface (option/accessory)

Access: Settings Screen + Menu [Set Points]		Choice - Setting limit
Hard Vacuum Set Point	Reject point	$1 \cdot 10^{-13} - 1 \cdot 10^{+06}$ $1 \cdot 10^{-07}$ 1)
	Set point 2	$1 \cdot 10^{-19} - 1 \cdot 10^{+19}$ $1 \cdot 10^{-07}$ 1) 2)
	Set point 3	$1 \cdot 10^{-19} - 1 \cdot 10^{+19}$ $1 \cdot 10^{-07}$ 1) 2)
	Set point 4	$1 \cdot 10^{-19} - 1 \cdot 10^{+19}$ $1 \cdot 10^{-07}$ 1) 2)
	Set point 5	$1 \cdot 10^{-19} - 1 \cdot 10^{+19}$ $1 \cdot 10^{-07}$ 1) 2)
Sniffer Set Point	Reject point	$1 \cdot 10^{-12} - 1 \cdot 10^{+06}$ $1 \cdot 10^{-04}$ 1)
	Probe clogged	$1 \cdot 10^{-19} - 1 \cdot 10^{+19}$ $1 \cdot 10^{-06}$ 1)
Other pressure set points 2)	Pressure set point #1	$5 \cdot 10^{-3} - 3 \cdot 10^{+2}$ $1 \cdot 10^{+1}$ 1)
	Pressure set point #2	$5 \cdot 10^{-3} - 3 \cdot 10^{+2}$ $1 \cdot 10^{+0}$ 1)
	Pressure set point #3	$5 \cdot 10^{-3} - 3 \cdot 10^{+2}$ $1 \cdot 10^{-1}$ 1)

1) Default setting

2) Function available with 37-pin I/O communication interface (option/accessory)

Tbl. 3: Default settings: 'Set Points' menu

Default settings: 'Test' menu

Access: Settings Screen + Menu [Test]		Choice - Setting limit
Method		Hard Vacuum 1) Sniffer
HV/Sniffer Correction	Status	Enabled Disabled 1)
	Setting (If enabled)	$1 \cdot 10^{-20} - 1 \cdot 10^{+20}$ $1 \cdot 10^0$ 1)
Mode (If 'Hard vacuum' test method)		Gross Leak Normal High Sensitivity 1)
Probe type (If 'Sniffer' test method)		Standard 1) Smart

1) Default setting

Access: Settings Screen + Menu [Test]				Choice - Setting limit
Cycle end	Cycle end			Operator ¹⁾ Automatic
	Setting (If automatic) (If 'Hard vacuum' test method)	Rough. timer	Status	Enabled ¹⁾ Disabled
			Setting (If enabled)	0 – 1 hr 10 s ¹⁾
		Test timer		0 – 1 hr 10 s ¹⁾
	Setting (If automatic) (If 'Sniffer' test method)	Threshold report	Status	Enabled Disabled ¹⁾
			Setting (If enabled)	0 – 1 hr 10 s ¹⁾
	Test timer		0 – 1 hr 10 s ¹⁾	
Memo Function	Active			No ¹⁾ Yes
	Display Time (if active)	Status		Enabled Disabled ¹⁾
		Setting (If automatic)		0 – 1 hr 10 s ¹⁾
Zero activation	Activation			Operator ¹⁾ Automatic
	Zero Exit (If 'operator')			Press once ¹⁾ Press > 3 s
	Trigger (If 'automatic')			Timer ¹⁾ Set point
	Setting (If 'automatic')	If Timer		0 – 1 hr 10 s ¹⁾
		(if set point)		$1 \cdot 10^{-19}$ – $1 \cdot 10^{+19}$ $5 \cdot 10^{-7}$ ¹⁾

1) Default setting

Tbl. 4: Default settings: 'Test' menu

Default settings: 'Spectro' menu

Access: Settings Screen + Menu [Spectro]	Choice - Setting limit
Tracer Gas	Helium 4 ¹⁾ Helium 3 Hydrogen
Filament selected	1 ¹⁾ 2
Filament	Off On ¹⁾
Filament status	0 – 100% 100% ¹⁾

1) Default setting

2) General information: read only

4) Information indicated on the calibrated leak used for calibration or on its calibration certificate

Access: Settings Screen + Menu [Spectro]			Choice - Setting limit
Calibrated leak	Tracer Gas		Helium 4 ¹⁾ Helium 3 Hydrogen
Type	If 'Hard vacuum' test method	Without 'Internal calibration' option/accessory	External ¹⁾
		With 'Internal calibration' option/accessory	Internal ¹⁾ External Machine
	If 'Sniffer' test method		Sniffer Ext. ¹⁾ Concentration
Unit			mbar · l/s ¹⁾ Pa · m ³ /s Torr · l/s atm · cc/s ppm
Leak Value			- ⁴⁾
Calibration valve (if 'internal' type)			Open Closed ¹⁾
Loss per Year (%)			0 – 99 6 ¹⁾
Reference Temperature (°C)			0 – 99 23 ¹⁾
Temperature Coefficient (%/°C)			0.0 – 9.9 3.0 ¹⁾
Year			- ⁴⁾
Internal temperature (°C) (if type = internal)			- ²⁾
External temperature (°C) (except if type = 'internal')			-

1) Default setting

2) General information: read only

4) Information indicated on the calibrated leak used for calibration or on its calibration certificate

Tbl. 5: Default settings: 'Spectro' menu

Default settings: 'Maintenance' menu

Access: Settings Screen + Menu [Maintenance]			Choice - Setting limit	
Detector			20 ^{1) 2)}	
Timers	Detector		20 ^{1) 2)}	
	Filament 1	Timer (h)	20 ^{1) 2)}	
		Reset timer	Function launching	-
	Filament 2	Timer (h)	0 ^{1) 2)}	
		Reset timer	Function launching	-
	Calibrated Leak		- ⁴⁾	
	Cycles	Counter (h)	0 ^{1) 2)}	
		Time interval		$1 \cdot 10^{+19} - 1$ 5 · 10⁺⁵ ¹⁾
		Reset counter	Function launching	-
	Secondary pump 1	Timer (h)	20 ^{1) 2)}	
		Time interval (h)		1 – 99999 17200 ¹⁾
		Reset timer	Function launching	-
		Speed (min ⁻¹)		- ²⁾
Detector Information	Access to general information		- ²⁾	
Pump Information	Secondary pump 1	Status	Synchro ²⁾	
		Rotation	- ²⁾	
		Speed (min ⁻¹)	- ²⁾	
		TMP information	Access to general information	- ²⁾
Events History			Vacuum ¹⁾	
Calibrations History			Vacuum ¹⁾	
Last maintenance	Maintenance work 1	Date	-	
		Total hours	-	
		Inspected by	-	
	Maintenance work 2	Date	-	
		Total hours	-	
		Inspected by	-	
	Maintenance work 3	Date	-	
		Total hours	-	
		Inspected by	-	

1) Default setting

2) General information: read only

4) Information indicated on the calibrated leak used for calibration or on its calibration certificate

Tbl. 6: Default settings: 'Maintenance' menu

Default settings: 'Configuration' menu

Access: Settings Screen + Menu [Configuration]		Choice - Setting limit
Unit/Date/ Language	Unit	- 3) mbar · l/s Pa · m ³ /s Torr · l/s mTorr · l/s atm · cc/s ppm sccm sccs
	Date	- 3) Format: Month Day Year (mm/dd/yyyy)
	Time	- 3) Format: Hour Minute Second (hh:mm:ss)
	Language	- 3) English French German Italian Chinese Japanese Korean Spanish Russian
Function keys	Setting	-

1) Default setting

2) General information: read only

3) No default setting: setting performed by the user at the 1st detector start-up

4) Information indicated on the calibrated leak used for calibration or on its calibration certificate

Access: Settings Screen + Menu [Configuration]				Choice - Setting limit
Application windows	Standard Window Parameters (main screen)	Leak Rate Bar-graph	Zoom on Set Point	No ¹⁾ Yes
			Low decade	$1 \cdot 10^{+5} - 1 \cdot 10^{-13}$ 1 · 10⁻¹² ¹⁾
			High decade	$1 \cdot 10^{+6} - 1 \cdot 10^{-12}$ 1 · 10⁻² ¹⁾
		Stand-By value		Hide Show ¹⁾
		Inlet Pressure		Hide Show ¹⁾
		Extra Pressure		Hide ¹⁾ Cell Exterior
	Standard (Main)	Access		Enabled ^{1) 2)}
		Order		1st ^{1) 2)}
	Graph	Access		Disabled Enabled ¹⁾
		Order (If shown)		2 nd – 4 th 2nd ¹⁾
	Synoptic	Access		Enabled Disabled ¹⁾
		Order (If shown)		2 nd – 4 th - ¹⁾
	Settings	Access		Disabled Enabled ¹⁾
		Order (If shown)		2 nd – 4 th 3rd ¹⁾
Screen Settings	Brightness		High ¹⁾ Low	
	Contrast		0 – 100 50% ¹⁾	
	Standby		None ¹⁾ 15 min 30 min 1 hr 2 hrs 4 hrs	
	Paging Function	Without remote control detected		-
		With remote control detected		No ¹⁾ Yes
	Reset panel parameters	Function launching		-

1) Default setting

2) General information: read only

3) No default setting: setting performed by the user at the 1st detector start-up

4) Information indicated on the calibrated leak used for calibration or on its calibration certificate

Access: Settings Screen + Menu [Configuration]		Choice - Setting limit
Access/Password	Password	0 – 9999 5555 ¹⁾
	Set points menu access	Lock Unlock ¹⁾
	Test menu access	Lock Unlock ¹⁾
	Spectro menu access	Lock Unlock ¹⁾
	Maintenance menu access	Lock Unlock ¹⁾
	Configuration menu access	Lock Unlock ¹⁾
	Advanced menu access	Lock Unlock ¹⁾
	User level	Restricted access Medium access Full access ¹⁾
	Change password	0 – 99999 5555 ¹⁾

1) Default setting

2) General information: read only

3) No default setting: setting performed by the user at the 1st detector start-up

4) Information indicated on the calibrated leak used for calibration or on its calibration certificate

Tbl. 7: Default settings: 'Configuration' menu

Default settings: 'Advanced' menu

Access: Settings Screen + Menu [Advanced]			Choice - Setting limit		
Leak detection	Start-up timer		0 – 1 hr 1 mn 30 s ¹⁾		
	Detector pressure gauge	Gauge	TPR/PCR ¹⁾ Linear		
		Position	Standard ¹⁾		
		Full scale (mbar) (if "linear")	0.1 – 50,000 1000 ¹⁾		
	External gauge	Gauge	None ¹⁾ TPR/PCR Linear		
		External Pressure (mbar)	-		
		Pressure Inlet Source	Internal ¹⁾ External		
		Full scale (mbar) (if "linear")	0.1 – 50,000 ³⁾		
	Calibration	Calibration		Operator ¹⁾ Manual	
		Calibration checking	Checking		Operator ¹⁾ Automatic
			Frequency (if 'automatic' check)	Cycles	0 – 9999 50 Cy. ¹⁾
				Hours	0 – 9999 10 hrs ¹⁾
	Analyzer Cell	Filament selected		1 ¹⁾ 2	
		Filament		Off On ¹⁾	
		Triode pressure		2)	
		Electronic zero		2)	
		Calibration valve		Off ¹⁾ On	
		Target value		2)	
		Acceleration Voltage (V)		2)	
		Emission (mA)		2)	
Sensitivity coefficient		2)			
Internal Temperature (°C)		2)			

1) Default setting

2) General information: read only

3) No default setting: setting performed by the user at the 1st detector start-up

4) Information indicated on the calibrated leak used for calibration or on its calibration certificate

5) See operating instructions for the communication interface

6) No default setting: depending on allocation

7) No default setting

Access: Settings Screen + Menu [Advanced]				Choice - Setting limit	
Leak detection	Dynamic calibration	Active		No ¹⁾ Yes	
		Value (if active)		$1 \cdot 10^{+19}$ - $1 \cdot 10^{-19}$ $1 \cdot 10^{-7}$ ¹⁾	
		Coefficient (if active)		1 ¹⁾	
	Signal processing	Level		Stable Stable+ ¹⁾ Fast	
Input/Output (15-pin I/O depending on option/accessory)	Serial link 1	Type		- ^{5) 6)}	
		Parameters	Mode		- ^{5) 6)}
			Handshake		- ^{5) 6)}
			Power Pin 9		- ^{5) 6)}
	Serial link 2	Type		- ^{5) 6)}	
		Parameters	Mode		- ^{5) 6)}
			Status		- ^{5) 6)}
			Address		- ^{5) 6)}
	I/O connector	Analog Output	9-gnd	Allocation	- ^{5) 6)}
			10-gnd 12-gnd	Value	- ^{5) 6)}
Input/Output (37-pin I/O depending on option/accessory)	Serial link 1	Type		- ^{5) 6)}	
		Parameters	Mode		- ^{5) 6)}
			Handshake		- ^{5) 6)}
			Power Pin 9		- ^{5) 6)}
	Serial link 2	Type		- ^{5) 6)}	
		Parameters	Mode		- ^{5) 6)}
			Handshake		- ^{5) 6)}
	I/O connector	Quick View	I/O set in the 37-pin D-Sub connector		- ^{5) 6)}
		Analog output	37-gnd 36-gnd 19-gnd	Allocation	- ^{5) 6)}
				Value	- ^{5) 6)}
		Digital input	11-gnd 30-gnd 12-gnd 31-gnd 13-gnd 32-gnd	Allocation	- ^{5) 6)}
				Activation	- ^{5) 6)}
	Digital Transistor Output	9 - 28 8 - 27 7 - 26 6 - 25	Allocation	- ^{5) 6)}	
Activation			- ^{5) 6)}		

1) Default setting

2) General information: read only

3) No default setting: setting performed by the user at the 1st detector start-up

4) Information indicated on the calibrated leak used for calibration or on its calibration certificate

5) See operating instructions for the communication interface

6) No default setting: depending on allocation

7) No default setting

Access: Settings Screen + Menu [Advanced]				Choice - Setting limit
Input/Output (37-pin I/O depending on option/accessory)	I/O connector	Digital Relay Output	5 - 24 4 - 23 3 - 22 2 - 21 1 - 20	Allocation - ^{5) 6)} Activation - ^{5) 6)}
		Select Default Configuration	Function launching	-
		Other configurations		- ^{5) 6)}
		Load Config. from SD Card	Function launching	-
SD card	Load LD Parameter	Function launching		-
	Save LD Parameter	Function launching		-
	Visualize *.BMP	Function launching		-
Secondary pump speed	Current (min ⁻¹ /Hz)		-	
	Target (min ⁻¹ /Hz)		1000 1500 60,000 90,000 ¹⁾	
Service	Access to 'Service' menu with password. Reserved for our Service Centers.			

1) Default setting

2) General information: read only

3) No default setting: setting performed by the user at the 1st detector start-up

4) Information indicated on the calibrated leak used for calibration or on its calibration certificate

5) See operating instructions for the communication interface

6) No default setting: depending on allocation

7) No default setting

Tbl. 8: Default settings: 'Advanced' menu

Initial settings: Graph screen - Graph parameters

Access: Press the graph			Choice - Setting limit
Graph parameters	Display time		12 secs – 1 hr 30 secs ¹⁾
	Auto scale	Status	Enabled Disabled ¹⁾
		Setting (if 'Auto scale' is enabled)	2 decades ¹⁾ 4 decades
	Decade (if 'Auto scale' is enabled)	High decade	-11 – +6 -4 ¹⁾
		Low decade	-12 – +5 -10 ¹⁾
Graph parameters	Show inlet pressure		Enabled Disabled ¹⁾
	Pressure decade (if 'Show inlet pressure' is enabled)	High decade	-2 – +3 +3 ¹⁾
		Low decade	-3 – +2 -3 ¹⁾

1) Default setting

Access: Press the graph		Choice - Setting limit
Enable record		Enabled Disabled ¹⁾
Sampling rate (if 'Enable record' is enabled)		100 ms – 30 s 500 ms ¹⁾
Clear recording (if 'Enable record' is enabled)	Function launching	-
View record (if 'Enable record' is enabled)	Function launching	-
1) Default setting		

Tbl. 9: Initial settings: Graph screen - Graph parameters

EC Declaration of Conformity

This declaration of conformity has been issued under the sole responsibility of the manufacturer.

Declaration for product(s) of the type:

**Leak detector
ASI 35**

We hereby declare that the listed product satisfies all relevant provisions of the following **European Directives**.

Machinery 2006/42/EC (Annex II, no. 1 A)
Electromagnetic compatibility 2014/30/EU
Restriction of the use of certain hazardous substances 2011/65/EU
Waste of Electrical and Electronic Equipment 2012/19/EU

Harmonized standards and national standards and specifications which have been applied:

EN 61000-6-2: 2005
EN 61000-6-4: 2007
EN 60204-1: 2006
ENV 50204: 1996

The person responsible for compiling the technical file is Mr. Cyrille Nominé, Pfeiffer Vacuum SAS, 98, avenue de Brogny B.P. 2069, 74009 Annecy cedex, France.

Signature:



Pfeiffer Vacuum SAS
98, avenue de Brogny
74009 Annecy cedex
France
B.P. 2069

(Guillaume Kreziak)
Managing Director

2023-02-16 Annecy



UK Declaration of Conformity

This declaration of conformity has been issued under the sole responsibility of the manufacturer.

Declaration for product(s) of the type:

**Leak detector
ASI 35**

We hereby declare that the listed product satisfies all relevant provisions of the following **British Directives**.

**Supply of Machinery (Safety) Regulations 2008
Electrical Equipment (Safety) Regulations 2016
The Restriction of the Use of Certain Hazardous Substances in Electrical and Electronic Equipment Regulations 2012**

Standards and specifications in force:

EN 61000-6-2: 2005
EN 61000-6-4: 2007
EN 60204-1: 2006
ENV 50204: 1996

The manufacturer's authorized representative in the United Kingdom and the authorized agent for compiling the technical documentation is Pfeiffer Vacuum Ltd, 16 Plover Close, Interchange Park, MK169PS Newport Pagnell.

Signature:



Pfeiffer Vacuum SAS
98, avenue de Brogny
74009 Annecy cedex
France
B.P. 2069

(Guillaume Kreziak)
Managing Director

2023-02-16 Annecy

**UK
CA**

VACUUM SOLUTIONS FROM A SINGLE SOURCE

Pfeiffer Vacuum stands for innovative and custom vacuum solutions worldwide, technological perfection, competent advice and reliable service.

COMPLETE RANGE OF PRODUCTS

From a single component to complex systems:

We are the only supplier of vacuum technology that provides a complete product portfolio.

COMPETENCE IN THEORY AND PRACTICE

Benefit from our know-how and our portfolio of training opportunities!

We support you with your plant layout and provide first-class on-site service worldwide.

Ed. 02 - Date 2023/08 - P/N:1278010EN



Are you looking for a
perfect vacuum solution?
Please contact us

Pfeiffer Vacuum GmbH
Headquarters • Germany
T +49 6441 802-0
info@pfeiffer-vacuum.de

www.pfeiffer-vacuum.com