



OPERATING INSTRUCTIONS

EN

Translation of the Original

ASM 390 - ASM 392

Leak detector

PFEIFFER  **VACUUM**

Disclaimer of liability

These operating instructions describe all models and variants of your product. Note that your product may not be equipped with all features described in this document. Pfeiffer Vacuum constantly adapts its products to the latest state of the art without prior notice. Please take into account that online operating instructions can deviate from the printed operating instructions supplied with your product.

Furthermore, Pfeiffer Vacuum assumes no responsibility or liability for damage resulting from the use of the product that contradicts its proper use or is explicitly defined as foreseeable misuse.

Copyright

This document is the intellectual property of Pfeiffer Vacuum and all contents of this document are protected by copyright. They may not be copied, altered, reproduced or published without the prior written permission of Pfeiffer Vacuum.

We reserve the right to make changes to the technical data and information in this document.

Table of contents

1	About this manual	7
1.1	Validity	7
	1.1.1 Products concerned	7
	1.1.2 Applicable documents	7
1.2	Target group	7
1.3	Conventions	7
	1.3.1 Pictographs	7
	1.3.2 Instructions in the text	8
	1.3.3 Labels	8
	1.3.4 Abbreviations	9
2	Safety	10
2.1	General safety information	10
	2.1.1 Safety instructions	10
	2.1.2 Precautions	12
2.2	Intended use	13
2.3	Foreseeable misuse	13
3	Transportation and Storage	14
3.1	Product receipt	14
3.2	Unpacking/Packing	14
3.3	Handling	15
3.4	Storage	15
4	Product description	17
4.1	Product identification	17
	4.1.1 Scope of delivery	17
	4.1.2 Variants	17
4.2	Connection interface	18
4.3	Control panel description	19
5	Installation	20
5.1	Detector installation	20
5.2	Control panel attachment	20
5.3	Hose holder attachment	20
5.4	Storage	21
5.5	Purge and inlet vent connection	22
	5.5.1 Standard equipment	22
	5.5.2 Neutral gas line connection	22
5.6	Exhaust connection	23
5.7	Electrical connection	23
5.8	Part/installation to be tested connection	24
6	Commissioning	25
6.1	Detector start-up	25
6.2	Detector powering off	25
6.3	Familiarise yourself with the control panel	25
7	Operation	26
7.1	Use conditions	26
7.2	Prerequisites for optimizing use	26
7.3	Operation monitoring	26
7.4	Test Start/Stop	27
7.5	Test launched automatically upon start-up	28
7.6	Calibration	28
	7.6.1 Calibration in hard vacuum test mode with internal calibrated leak	29
	7.6.2 Calibration in hard vacuum test mode with external calibrated leak	29

7.6.3	Calibration in hard vacuum test mode with a pumping system in parallel	30
7.6.4	Calibration in sniffing test with internal calibrated leak	30
7.6.5	Calibration in sniffing test with external calibrated leak	30
7.6.6	Calibration in sniffing test on concentration	31
7.7	Zero Function	31
7.8	Touch screen	32
7.8.1	Navigation	33
7.8.2	Main screen	33
7.8.3	Graph screen	34
7.8.4	Graph screen: graph parameters	35
7.8.5	Graph screen: graph clearing	35
7.8.6	Graph screen: recording a graph	35
7.8.7	Graph screen: scales	36
7.8.8	Graph screen: saving a recording	37
7.8.9	Graph screen: viewing a recording	38
7.8.10	Settings screen	39
7.8.11	Vacuum circuit screen	40
7.8.12	'Measurement' window	40
8	Settings	41
8.1	Set points menu	42
8.1.1	Audio alarm and digital voice	42
8.1.2	Pollution function	43
8.1.3	Hard vacuum reject point	43
8.1.4	Sniffing reject point	44
8.1.5	Probe clogged threshold	44
8.1.6	Other set points	44
8.1.7	Other pressure set points	45
8.2	Test menu	45
8.2.1	Test method	45
8.2.2	Correction factor	46
8.2.3	Test mode	46
8.2.4	Probe type	47
8.2.5	Automatic cycle end	47
8.2.6	Inlet vent	47
8.2.7	Memo function	48
8.2.8	Zero activation	49
8.2.9	Bypass option	49
8.2.10	Regeneration	50
8.2.11	Massive mode	51
8.3	Spectro menu	51
8.3.1	Tracer gas	51
8.3.2	Filament parameters	52
8.3.3	Calibrated leak	52
8.4	Maintenance menu	53
8.4.1	Detector	54
8.4.2	Timers	54
8.4.3	Detector information	56
8.4.4	Pump information	56
8.4.5	Event history	57
8.4.6	Calibration history	58
8.4.7	Burn-in	58
8.4.8	Secondary pump and analyzer cell maintenance	58
8.4.9	Last maintenance	59
8.5	Configuration menu	59
8.5.1	Time – Date – Unit – Language	59
8.5.2	Function keys	59
8.5.3	Application windows	60

8.5.4	Screen settings	63
8.5.5	Access – Password	63
8.6	Advanced menu	67
8.6.1	Leak Detection: Start Up timer	67
8.6.2	Leak Detection: Background suppression	67
8.6.3	Leak Detection: Crossover pressures	67
8.6.4	Leak Detection: Calibration	68
8.6.5	Leak Detection: Analyzer cell	69
8.6.6	Leak Detection: Internal Pirani gauge calibration	70
8.6.7	Leak Detection: External gauge	70
8.6.8	Input/Output: Serial link 1 and Serial link 2	71
8.6.9	Input/Output: I/O connector	72
8.6.10	SD Card menu	72
8.6.11	Service	73
9	Maintenance/Replacement	74
10	Accessories	75
11	Technical data and dimensions	76
11.1	General	76
11.2	Technical characteristics	76
11.3	Units of pressure	77
11.4	Gas throughputs	77
11.5	Dimensions	77
12	Appendix	79
12.1	Tree diagram of the Settings menu	79
12.2	15-pin Input/Output communication interface	90
12.2.1	Cable characteristics	90
12.2.2	Interface	91
12.2.3	Save	91
12.2.4	Setting	91
12.2.5	Formulas	92
12.3	RS-232 Serial link	93
12.3.1	Cable characteristics	94
12.3.2	Interface	94
12.3.3	Setting	94
	UL/CSA compliance	96
	SEMI Certificate	97
	UK Declaration of Conformity	98
	EC Declaration of Conformity	99

List of tables

Tbl. 1:	Accessories	75
Tbl. 2:	Environmental conditions	77
Tbl. 3:	Units of pressure and their conversion	77
Tbl. 4:	Gas throughputs and their conversion	77
Tbl. 5:	Default settings: 'Set Points' menu	80
Tbl. 6:	Default settings: 'Test' menu	81
Tbl. 7:	Default settings: 'Spectro' menu	82
Tbl. 8:	Default settings: 'Maintenance' menu	84
Tbl. 9:	Default settings: 'Configuration' menu	86
Tbl. 10:	Default settings: 'Advanced' menu	89
Tbl. 11:	Initial settings: Graph screen - Graph parameters	90
Tbl. 12:	Initial settings: Graph screen - Recording parameters	90

1 About this manual



IMPORTANT

Read carefully before use.
Keep the manual for future consultation.

1.1 Validity

This operating instructions is a customer document of Pfeiffer Vacuum. The operating instructions describe the functions of the named product and provide the most important information for the safe use of the device. The description is written in accordance with the valid directives. The information in this operating instructions refers to the product's current development status. The document shall remain valid provided that the customer does not make any changes to the product.

1.1.1 Products concerned

This document applies to products with the following part numbers:

Part Number	Description
CSGB01GxMM9x	ASM 390
ESGB02GxMM9x	ASM 392

1.1.2 Applicable documents

Document	Part Number
Maintenance instructions - ASM 390-392	126348M ¹⁾
Operating instructions - RS-232 Serial link	122215 ¹⁾
Operating instructions - 15-pin I/O communication interface	121776 ¹⁾
Operating instructions - 37-pin I/O communication interface (Wi-Fi + Ethernet + USB)	123894 ¹⁾
Operating instructions - ECB Wi-Fi external communication box	126169 ¹⁾
Operating instructions - Standard sniffer probe	121780 ¹⁾
Operating Instructions - Smart sniffer probe	BG5268B ¹⁾
Operating instructions - Spray gun	121781 ¹⁾
Operating instructions - RC 10 remote control	124628 ¹⁾
Operating Instructions - Bypass	PL0004B ¹⁾
Operating instructions - ASM 390-392 bottle-holder	126760 ¹⁾
UL/CSA Declaration of conformity	Included with this manual
SEMI Declaration of conformity	Included with this manual
EC Declaration of conformity	Included with this manual

¹⁾ also available at www.pfeiffer-vacuum.com

1.2 Target group

This user manual is intended for all persons in charge of transport, installation, commissioning/decommissioning, use, maintenance or storage of the product.

The work described in this document must only be carried out by persons with suitable technical training (specialized staff) or persons who have undergone Pfeiffer Vacuum training.

1.3 Conventions

1.3.1 Pictographs

Pictographs used in the document indicate useful information.



Note



Tip



Key point on the illustration to be checked



Stated tightening torque to be applied



Respect the chronological order of operations and/or assembly/disassembly direction

1.3.2 Instructions in the text

Usage instructions in the document follow a general structure that is complete in itself. The required action is indicated by an individual step or multi-part action steps.

Individual action step

A horizontal, solid triangle indicates the only step in an action.

- ▶ This is an individual action step.

Sequence of multi-part action steps

The numerical list indicates an action with multiple necessary steps.

1. Step 1
2. Step 2
3. ...

1.3.3 Labels

INPUTS/OUTPUTS	Inputs/Outputs communication interface connector
SERIAL	9-pin D-Sub RS-232 serial link connector
NETWORK	Ethernet plug
USB	USB plug

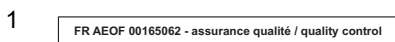

This label guarantees to the user that the product packaging has not been opened since leaving the factory.

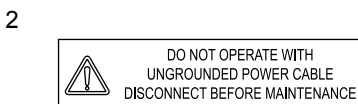

This label indicates that some of the internal parts are electrically live and could cause electrical shock in case of contact.

- Do not use the product if the main power supply cable is not earthed.
- Disconnect the main power supply cable from the product before servicing the product.



This label indicates that some of the internal parts are electrically live and could cause electrical shock in case of contact.

- Disconnect the main power supply cable from the product before removing the cover.



This label indicates that the detector's exhaust should not be blocked.



This label indicates the grounding point on the product.

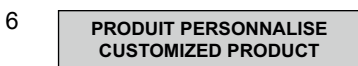

This label indicates that the product has been customized at the customer's request.



This label indicates that the product has been certified compliant with quality control upon leaving the factory.

8  This label indicates that the product is subject to regulations for the treatment of electrical and electronic equipment waste (refer to the EC declaration of conformity for the product).

9

HLD1302577 - RS232	
Bluetooth MAC address XXXXXX / None	
Network MAC address xx:xx:xx:xx:xx:xx / None	

 This label indicates the MAC address for the options installed in the product.

(Example)

10

Pu_GL : 1	Pu_N : 1
Mu_GL : 12856	Mu_N : 31

Mu_Cal : 1	Mu_LDS : 1800

 For service centers use only

(Example)

11



DD-MM-YY ^④		
Factory Firmware /Logiciel usine		
L0232	V3302	E17D
L0264	V3200	FD87E7D
L0285	V3200	8C9D
①	②	③

 This label provides information regarding firmware installed in the product.

- 1 Firmware name
- 2 Firmware version
- 3 Firmware checksum
- 4 Publication date

(Example)

12

PFEIFFER  VACUUM 			
98 avenue de Brogny F-74000 ANNECY Made in France			
1 Kg	2 V	3 Hz	4 W
P/N: 5	6		
S/N: 7	8		
			

 Product rating plate.

- 1 Weight
- 2 Use voltage
- 3 Use frequency
- 4 Maximum power consumption
- 5 Part Number
- 6 Description
- 7 Serial number
- 8 Date of manufacture

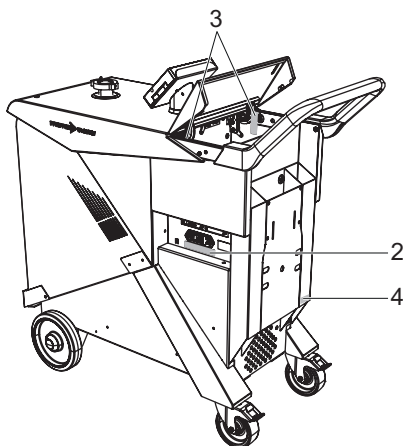

1.3.4 Abbreviations

- I/O Input/Output
- ⁴He Helium 4
- ³He Helium 3
- H₂ Hydrogen
- [XXXXXX] Control panel menus and settings
e.g. [Measure] [Tracer Gas] to select the tracer gas used for the test.

2 Safety

2.1 General safety information

The following 4 risk levels and 1 information level are taken into account in this document.

⚠ DANGER
<p>Immediately pending danger</p> <p>Indicates an immediately pending danger that will result in death or serious injury if not observed.</p> <ul style="list-style-type: none"> ▶ Instructions to avoid the danger situation

⚠ WARNING
<p>Potential pending danger</p> <p>Indicates a pending danger that could result in death or serious injury if not observed.</p> <ul style="list-style-type: none"> ▶ Instructions to avoid the danger situation

⚠ CAUTION
<p>Potential pending danger</p> <p>Indicates a pending danger that could result in minor injuries if not observed.</p> <ul style="list-style-type: none"> ▶ Instructions to avoid the danger situation

NOTICE
<p>Danger of damage to property</p> <p>Is used to highlight actions that are not associated with personal injury.</p> <ul style="list-style-type: none"> ▶ Instructions to avoid damage to property

i	<p>Notes, tips or examples indicate important information about the product or about this document.</p>
----------	---

2.1.1 Safety instructions

All safety instructions in this document are based on the results of the risk assessment carried out in accordance with Low-Voltage Directive 2014/35/EU regarding electrical safety. Where applicable, all life cycle phases of the product were taken into account.

⚠ WARNING
<p>Risk of electric shock due to non-compliant electrical installations</p> <p>This product uses mains voltage for its electrical supply. Non-compliant electrical installations or installations not done to professional standards may endanger the user's life.</p> <ul style="list-style-type: none"> ▶ Only qualified technicians trained in the relevant electrical safety and EMC regulations are authorized to work on the electrical installation. ▶ This product must not be modified or converted arbitrarily.

⚠ WARNING
<p>Electric shock hazard</p> <p>Voltage and current can cause electric shock.</p> <p>Only skilled, authorized people may carry out maintenance work.</p> <ul style="list-style-type: none"> ▶ Insulate and lock the power supply circuit by positioning the circuit breaker on O. ▶ Disconnect the power supply cable from all power sources before working on the product and/or removing the covers.

⚠ WARNING**Risk of electric shock in case of contact with products that are not electrically isolated**

When powering off _mains switch to **O_**, certain components located between the mains connection and the circuit breaker will still contain an electric charge (live). There is a risk of electric shock in case of contact.

- ▶ Make sure that the mains connection is always visible and accessible so that it can be unplugged at any time.
- ▶ Disconnect the mains cable from the electrical network before working on the product.
- ▶ Wait for the control panel screen to turn off completely before working on the product and/or removing the cover(s).

⚠ WARNING**Health risk related to residual traces on the parts tested**

A leak detection operation must be carried out under environmental conditions that do not present any risks to the operator and the equipment. The user and/or integrator of the product are fully responsible for the operational safety conditions of the equipment.

- ▶ Do not test parts or equipment with traces of harsh, chemical, corrosive, inflammable, reactive, toxic, or explosive substances, nor condensable vapors, even in small amounts.
- ▶ Apply the relevant safety instructions in accordance with local regulations.

⚠ WARNING**Risk of serious injury due to falling objects**

When transporting parts/components and during product maintenance, there is a danger of injury caused by loads slipping or falling.

- ▶ Carry small and medium-size components with both hands.
- ▶ Transport components that weigh more than 20 kg using suitable lifting gear.
- ▶ Wear safety shoes with steel toes in accordance with directive EN 347.

⚠ WARNING**Risk of burns in case of contact with hot surfaces**

For the operator's safety, the products are designed to avoid thermal risk. However, specific operating conditions may exist that require extra caution on the part of the operator due to the high temperatures (surfaces > 70 °C for parts inside the cover(s)).

- ▶ Wait for the product to fully cool down before working on it.
- ▶ Protective gloves must be worn in accordance with standard EN ISO 21420.

⚠ CAUTION**Risk of crushing related to product tilting**

Although the product fully complies with EU safety regulations, there is a risk of tilting when the product is not correctly installed or used.

- ▶ Place the product on a flat, hard floor.
- ▶ Keep the product on its 4 feet.

⚠ CAUTION**Risk of the product tilting during unpacking/packing**

The transport pallet for the detector packaging is equipped with an access ramp.

Product should be removed from its packaging only by personnel qualified and trained in handling heavy materials.

- ▶ Ensure a space equivalent to the length of the detector is free in alignment with the access ramp.
- ▶ Always hold the detector by its handle to guide it and slow it on the access ramp.

⚠ CAUTION

Risk of pinching fingers
 When handling the cover or the work surface, there is a risk of fingers becoming pinched.

- ▶ Keep hands away from the sides while handling the cover.
- ▶ Keep fingers away from the fastening latches when closing the cover or the work surface.

NOTICE

Incorrect use of purge
 A leak detection operation should be carried out on parts or equipment that contain any trace of substances that are aggressive, chemical, corrosive, inflammable, reactive, toxic, explosive, or on condensable vapors, even in small quantities.

- ▶ Do not use the purge to dilute these hazardous products. This is not its purpose.

2.1.2 Precautions

i **Duty to provide information on potential dangers**
 The product holder or user is obliged to make all operating personnel aware of dangers posed by this product.
 Every person who is involved in the installation, operation or maintenance of the product must read, understand and adhere to the safety-related parts of this document.

i **Obligation to provide personal protective equipment**
 The operators or employers are obliged to provide the user of the product with the necessary personal protective equipment (PPE).
 Persons responsible for installing, operating and repairing the product must wear PPE for safety.

i **Infringement of conformity due to modifications to the product**
 The Declaration of Conformity from the manufacturer is no longer valid if the operator changes the original product or installs additional equipment.

- Following the installation into a system, the operator is required to check and re-evaluate the conformity of the overall system in the context of the relevant European Directives, before commissioning that system.

i **Installation and use of the accessories**
 The products can be fitted with special accessories.
 The installation, use and refurbishment of the connected accessories are described in detail in the respective operating instructions.

- Only use original accessories.
- Accessory part numbers (see chapter "Accessories").

Only qualified personnel trained in safety regulations (EMC, electrical safety, chemical pollution) are authorized to carry out the installation and maintenance described in this manual. Our service centers can provide the necessary training.

- ▶ Do not remove the blanked-off flange from the inlet port while the product is not in use.
- ▶ Do not expose any part of the human body to the vacuum.
- ▶ Follow the safety and accident prevention requirements.
- ▶ Regularly check compliance with all precautionary measures.
- ▶ Do not turn on the product if the cover is not in place.
- ▶ Do not move the product while it is in use (product powered on).
- ▶ Use the product's brakes to immobilize it during use (product powered on).

2.2 Intended use

The leak detector is designed to detect and/or quantify a possible installation or component leak by searching for the presence of a tracer gas in the pumped gases.

Only the tracer gases identified in this manual may be used.

The product may be used in an industrial environment.

2.3 Foreseeable misuse

Misuse of the product will render the warranty and any claims void. Any use, whether intended or not, that diverges from the uses already mentioned will be treated as non-compliant; this includes but is not limited to:

- use of a tracer gas with a hydrogen concentration greater than 5%,
- testing parts that are soiled or that have traces of water, vapors, paint, adhesive, detergent or rinsing products,
- pumping of liquids,
- pumping of dust or solids,
- pumping of corrosive, explosive, aggressive or flammable fluids,
- pumping of reactive, chemical or toxic fluids,
- pumping of condensable vapors,
- operation in potentially explosive areas,
- product movement as soon as the product is power on,
- use of accessories or spare parts, which are not named in this manual,
- use of accessories or spare parts, which are not sold by the manufacturer.

The product is not designed to carry people or loads and is not for use as a seat, stepladder or any other similar purpose.

3 Transportation and Storage

3.1 Product receipt



Condition of the delivery

- Check that the product has not been damaged during transport.
- If the product is damaged, take the necessary measures with the carrier **and** notify the manufacturer.

- ▶ Keep the product in its original packaging so it stays as clean as it was when dispatched by us: only unpack the product once it has arrived at the location where it will be used.
- ▶ Keep the blank-off flange on the inlet port (inlet) when the product is not in use.



Keep the packaging (recyclable materials) in case the product needs to be transported or stored.

3.2 Unpacking/Packing

⚠ CAUTION

Risk of the product tilting during unpacking/packing

The transport pallet for the detector packaging is equipped with an access ramp.

Product should be removed from its packaging only by personnel qualified and trained in handling heavy materials.

- ▶ Ensure a space equivalent to the length of the detector is free in alignment with the access ramp.
- ▶ Always hold the detector by its handle to guide it and slow it on the access ramp.

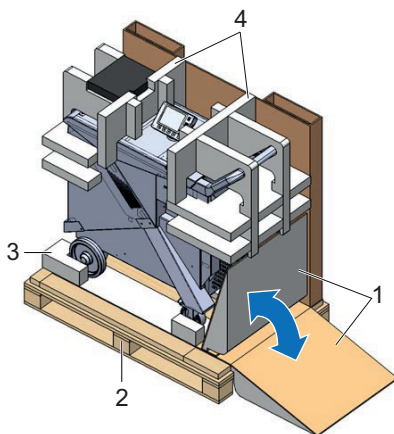

- | | |
|--------------------|-------------------|
| 1 Foam access ramp | 3 Foam stop |
| 2 Transport pallet | 4 Protective foam |

Unpacking

1. Remove the box.
2. Remove the cover and the protective foam.
 - A foam access ramp, attached to the transport pallet, unfolds: it allows the detector to be removed from the pallet.
3. Remove the box containing the accessories.
4. Remove the brakes on the detector's rear wheels.
5. Remove the detector from the transport pallet: slide the detector on the foam access ramp, holding it by the handle to slow it down.
6. Remove the yellow protective film from the wheels.
7. Remove the protective film from the control panel.

Packaging

When sending the detector to a service center, keep the accessories delivered with the detector. Do not return them with the product.

1. Check that the storage boxes are empty.
2. If the leak detector is fitted with accessories connected to the inlet port or any other customization, remove them.
3. Install a blank-off flange on the inlet port.
4. If the leak detector is fitted with the bottle holder accessory, remove it and refit the handle in the initial position (see bottle holder operating instructions).
5. Place the detector on the transport pallet: slide the detector on the foam ramp by pushing it with the handle and immobilize the front of the detector against the foam stop on the transport pallet.
6. Put the brakes on the detector's rear wheels.
7. Fit the cover and the protective foam.
 - Lift the foam access ramp before fitting the cover.
8. Put the box and strap the box and pallet.

3.3 Handling

WARNING

Risk of crushing during product handling

Given the weight of the product, there is a risk of crushing during handling operations. Under no circumstances shall the manufacturer be liable if the following instructions are not followed:

- ▶ Only qualified staff trained in handling heavy objects are authorized to handle the product.
- ▶ The lifting devices provided **must be used** for the product and the procedures set out in this document must be followed.

WARNING

Risk of crushing related to product tilting

Although the product fully complies with the EU safety regulations, there is a risk of tilting when it is moved over the floor or is not properly secured or used.

- ▶ Do not place the product on a plane with an incline greater than 3° (or 6%): its weight could cause the operator to be dragged.
- ▶ Place the product on a flat, hard floor.
- ▶ Use the wheels to move the product.
- ▶ Do not push the product sideways.
- ▶ Do not press on the sides of the product.
- ▶ Do not leave anything pressing against the product.

NOTICE

Damage to the equipment if a detector is handled while switched on

If it is necessary to move or work on the product, the user must first make sure that the detector is fully shut down, otherwise there is a risk of damage to some of the detector components. When the main switch/circuit breaker is set to **O**:

- ▶ Unplug the power cable.
- ▶ Wait 5 minutes after power-off before working on the product.

- ▶ Move the product using the handle or the gripping area located at the front of the work surface.
- ▶ Do not move the product using the bumper, the control panel (or its arm) or the inlet port.

3.4 Storage



Pfeiffer Vacuum recommends storing the products in their original transport packaging.

New product storage

- ▶ Leave the product in its packaging.
- ▶ Leave the blanked-off flange in place on each port.
- ▶ Store the module in a clean and dry environment according to the permitted temperature conditions (see chapter “Technical characteristics”).
- ▶ Beyond 3 months, factors such as temperature, humidity, salt in the air, etc. could damage some components (elastomers, lubricants, etc.). If this happens, contact your service center.

Extended storage

With this procedure, the detector remains under vacuum, reducing the degassing time spent when it is switched on again.

1. Install the blank-off flange on the inlet port.
2. In the 'Test' menu, check:
 - that the 'hard vacuum' test method is selected,
 - that the most sensitive test mode is selected,
 - that the air inlet valve is set to 'Operator'.
3. Begin the test by pressing the **START/STAND-BY** button.
 - Wait until the leak detector reaches the most sensitive test mode.
4. Make sure that the inlet vent is disable.
5. Stop the test by pressing the **START/STAND-BY** button.
6. Stop the detector (set main switch/circuit breaker to **O**).
7. Wait for the control panel turn off.
8. Unplug the main power supply cable.

4 Product description

4.1 Product identification

To correctly identify the product when communicating with our service center, always have the information from the product rating plate available (see chapter "Labels").

4.1.1 Scope of delivery

- 1 leak detector
- 1 set of documentation (USB stick, operating instructions, plastic coated memos for the detector and the RS-232 serial link)
- 1 main power supply cable for Europe (France/Germany) and/or 1 power cable for US
- 1 calibration certificate for the internal calibrated leak
- 1 quality control certificate for the product
- 1 maintenance kit
- 1 groundsheet (in the storage box)
- 1 batch of partitions for compartmentalization (in the storage box)
- 1 Quality Control label
- 1 hose holder
- 1 adaptor for using the Smart sniffer probe
- 1 15-pin or 37-pin D-Sub male connector cover (depending on option)
- 1 15-pin or 37-pin D-Sub male connector (depending on option)

4.1.2 Variants

ASM 390-392 leak detectors are mobile, high-performance detectors with dry pumps.

They are designed for applications for which ultra-cleanliness and a high pumping speed are essential (semiconductors, coating, etc.).

- ASM 390: with a tracer gas pumping speed of more than 10 l/s, the ASM 390 provides fast response time.
- ASM 392: equipped with 2 turbomolecular pumps, the ASM 392 provides the fastest tracer gas pumping speed on the market in order to meet the needs of highly demanding applications.

4.2 Connection interface

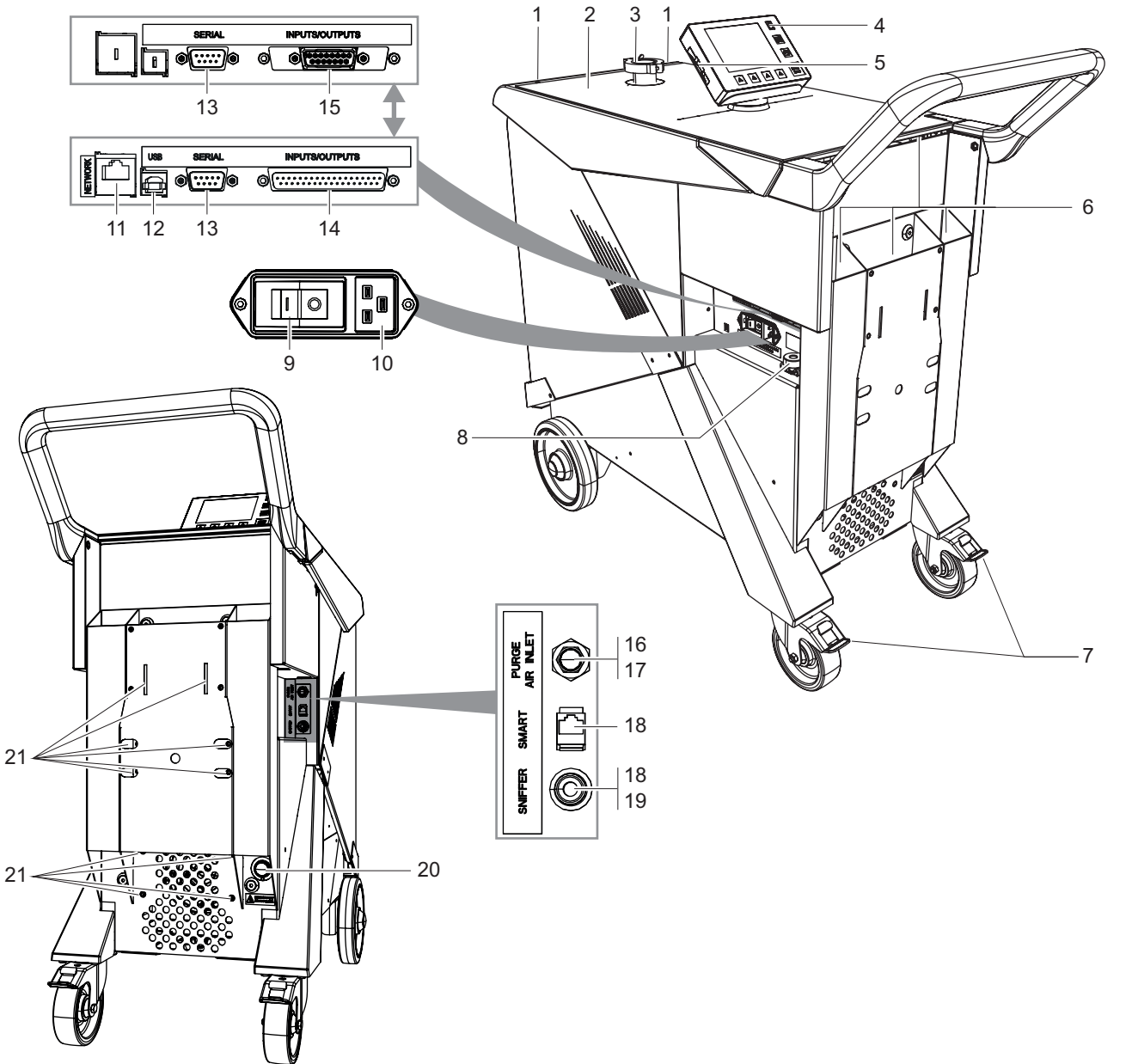

- | | |
|--|--|
| <ul style="list-style-type: none"> 1 Hose holder attachment point 2 Work surface 3 Detector inlet port (inlet)
 4 Standard remote control connector ¹⁾ 5 SD Card 6 Storage trays 7 Brakes 8 Attachment for securing the main power supply cable 9 Main switch/Circuit breaker 10 Power supply 11 Ethernet plug (NETWORK) ¹⁾ | <ul style="list-style-type: none"> 12 USB plug (USB) 13 9-pin D-Sub RS-232 serial link connector (SERIAL) 14 37-pin D-Sub I/O communication interface connector (INPUTS/OUTPUTS) ¹⁾ 15 15-pin D-Sub I/O communication interface connector (INPUTS/OUTPUTS) ¹⁾ 16 Inlet vent connector 17 Purge input connector 18 Smart sniffer probe connector (SMART SNIFFER) ¹⁾ 19 Standard sniffer probe connector (STANDARD SNIFF-ER) ¹⁾ 20 Exhaust for primary pump (EXHAUST) ¹⁾ 21 Bottle holder attachment point ¹⁾ |
|--|--|

1) Accessory or option (at the customer's charge)

4.3 Control panel description

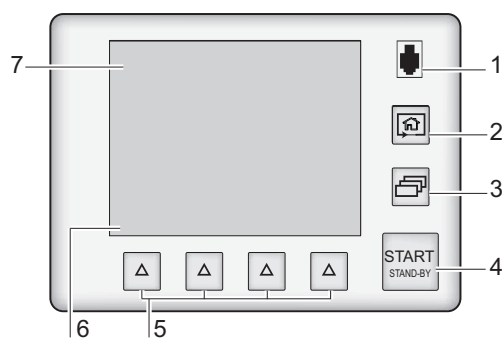

1	Standard remote control connection (accessory).
2	Changing the application screens: return to the home page ("standard" screen) from any menu.
3	Changing the level of function keys.
4	START/STAND-BY button Test Start/Stop.
5	Quick access to functions (see chapter "Function keys").
6	Displaying a function key level: starting the function or displaying a sub-menu by touching the screen.
7	Application screens (touch screen): these are accessible or hidden.

5 Installation

5.1 Detector installation

NOTICE

Leak detector ventilation

In cases of poor ventilation, there is a risk of deterioration of the detector's internal components by heating.

- ▶ Comply with the ambient operating temperature.
- ▶ Do not obstruct the ventilation grids.
- ▶ Ventilation grids should be cleaned regularly.
- ▶ Leave a free space of at least 10 cm all around the leak detector.
- ▶ Store nothing under the detector.

⚠ WARNING

Movement risk

The detector is equipped with wheels to facilitate its movement.

The detector must be immobilized when it is being used or maintained.

- ▶ Put the brakes on the rear wheels.

- The inlet pressure must be no higher than atmospheric pressure. Pressure that is too high can damage the detector.
- The detector's performance depends on the type of accessories used and on the quality of the mechanical connections.
- Comply with these recommendations to optimize measurement (see chapter "Prerequisites for optimizing use").
- The total weight of the parts, accessories, etc. placed on the detector work surface must not exceed 50 kg.
- ▶ Choose the location for set up according to the dimensions of the detector (see chapter "Dimensions").
- ▶ Handle the detector using the handling device (see chapter "Handling").
- ▶ The leak detector must be installed on a horizontal flat surface resting on its wheels.
- ▶ Make sure that the test area is not polluted by the tracer gas (ventilated room).
- ▶ Test that the entire line is completely sealed when the detector is attached to the pumping circuit, to ensure that the connections are correct (pump, pipes, valves, etc.).
- ▶ When assembling the vacuum circuit, use accessories to shut off the product and make maintenance easier (inlet shut off valves, purge systems, etc.).

5.2 Control panel attachment

The control panel is magnetized so you can place it on any metallic surface.

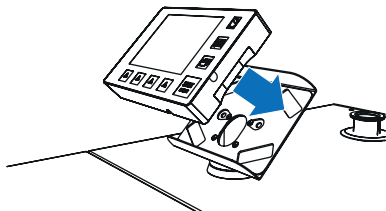

5.3 Hose holder attachment

The DN 40 ISO-KF hose holder (delivered without centering ring, o-ring, and clamp) is used to affix the hose connecting the inlet of the detector to the installation to be tested, during handling or extended storage, and to keep the detector inlet and the hose under vacuum.

The hose holder is attached on one of 2 inserts provided for this purpose.

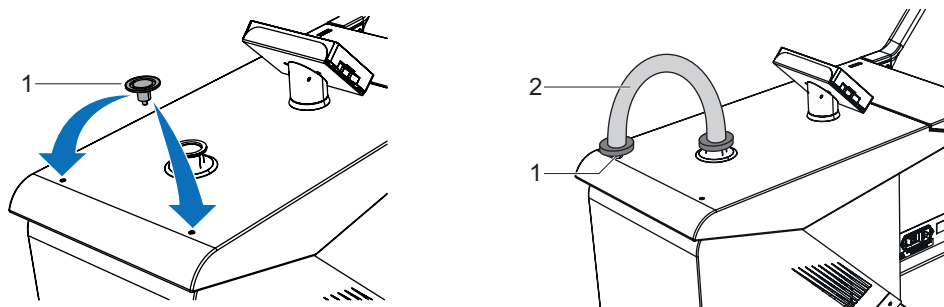

1 Hose holder 2 Flexible tube

5.4 Storage

The leak detector includes a lockable storage box and flexible storage trays.

The batch of partitions delivered with the product allows for compartmentalization of the storage box for the user's convenience.

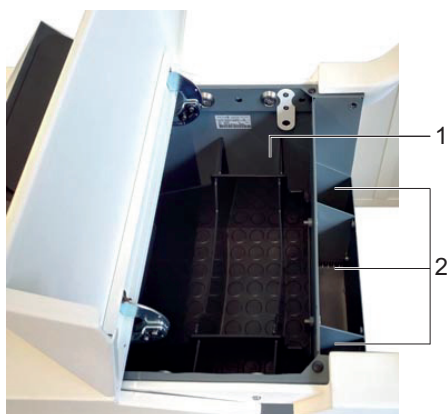

1 Storage box 2 Flexible storage tray

Storage box cover locking

It is possible to lock the cover of the storage box using a padlock (padlock not included, at the customer's charge).

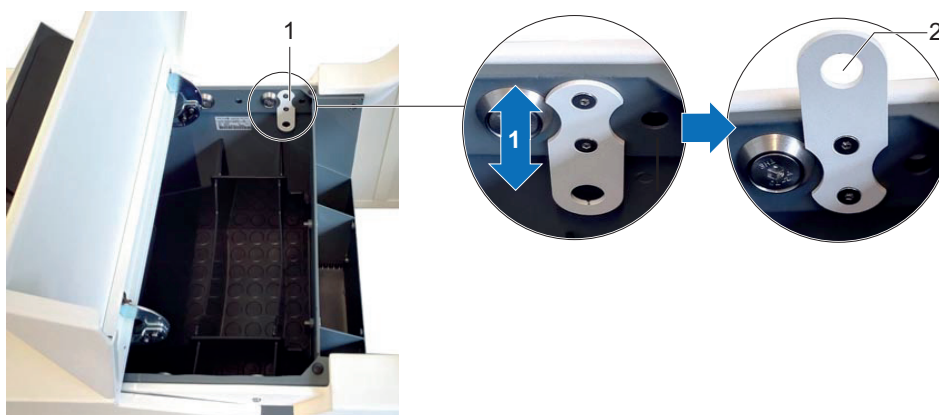

1 Locking plate 2 Location for padlock

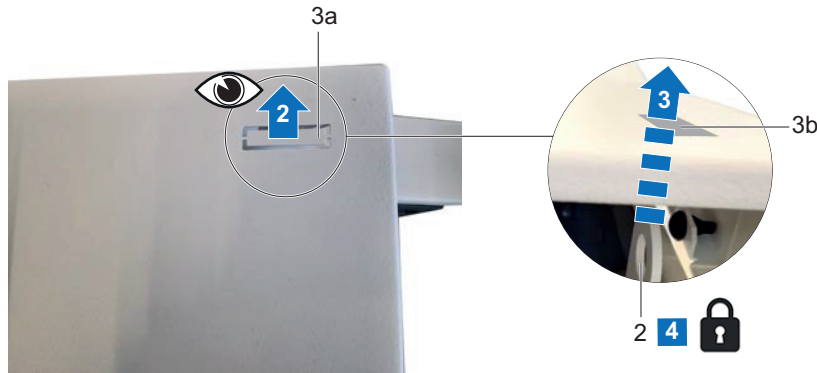

 **The use of a small flat tool (a screwdriver, for example) is necessary to remove the cover plate from the access window in order to provide access for the locking plate.**

- 2 Location for padlock
- 3a Access window (cover plate not removed)
- 3b Access window (cover plate removed)
- 4 Padlock

5.5 Purge and inlet vent connection

5.5.1 Standard equipment

NOTICE

Risk of pollution from tracer gas

The leak detector should not be used in an environment with a high concentration of tracer gas. The tracer gas risks polluting the leak detector.

The manufacturer cannot be held responsible for the product's pollution with tracer gas.

- ▶ Ensure good ventilation in the area where the detector will be used.

NOTICE

Incorrect use of purge

A leak detection operation should be carried out on parts or equipment that contain any trace of substances that are aggressive, chemical, corrosive, inflammable, reactive, toxic, explosive, or on condensable vapors, even in small quantities.

- ▶ Do not use the purge to dilute these hazardous products. This is not its purpose.

The detector is equipped with an inlet vent and an automatic purge optimizing the detector's operation.

- If no system is connected, the inlet vent and the purge are connected to the ambient air.
- The purge maintains a flow of air inside the detector
- The inlet vent status (opened or closed) depends on the parameters set by the user (see the chapter "Inlet vent").

The purge and inlet vent connector is delivered equipped with a protection filter (standard equipment). In addition to the purge, activating the 'Pollution' function is recommended (see chapter "Pollution function").

5.5.2 Neutral gas line connection

In place of the protective filter (standard equipment), it is possible to connect the detector to a neutral gas line (at the customer's charge).

The use of a neutral gas (nitrogen, for example) allows for the leak detector background to be reduced. The neutral gas should be different than the tracer gas used.

⚠ WARNING**Risk of injury due to elevated pressure in a pipe**

The neutral gas supply circuit is pressurized.

There is a risk of explosion, implosion, or rupture of the components during maintenance operations, which is likely to cause injuries and to damage the detector.

To work on the product without this risk, the user should lock the neutral gas supply circuit.

- ▶ Install a manual valve on the neutral gas circuit at a distance of 3 m from the product.

Flow

To guarantee best performance, the neutral gas supply must be dry and filtered, with the following characteristics:

- relative excess pressure: 200 hPa
- flow rate: 5000 sccm (if pressure= 1 bar (absolute) at the inlet)

Use pressure

If the neutral gas pressure is too high, the inlet valve may remain closed.

- 0 to 0.3 bar relative (\approx 0 to 4.5 psig)
- 1 to 1.3 bar absolute (\approx 14.5 to 19 psig)

Procedure

1. Remove the inlet vent and purge connector filter (see chapter "Connection interface").
2. Connect the neutral gas pipework to the inlet vent and purge connector (see chapter "Connection interface").

5.6 Exhaust connection

The detector exhaust must never be obstructed.

The detector is equipped with one of the following components at its exhaust (option/accessory):

- metal filter
- DN 25 ISO-KF pipe
- DN 40 ISO-KF pipe

NOTICE**Risk of deterioration due to overpressure at exhaust**

Too much pressure at the detector's exhaust risks damaging the detector.

- ▶ Ensure that the customer application exhaust line is always under slightly negative pressure.
- ▶ Make sure the detector's exhaust pressure does not exceed 200 hPa (relative).

If degassing the customer application, you are advised to connect the detector exhaust to an exhaust line (at the customer's charge), ensuring that the detector is always used in compliance with the recommendations given.

The detector must always be compliant with its initial use (see chapter "Intended use").

5.7 Electrical connection

⚠ WARNING**Risk of electric shock due to non-compliant electrical installations**

This product uses mains voltage for its electrical supply. Non-compliant electrical installations or installations not done to professional standards may endanger the user's life.

- ▶ Only qualified technicians trained in the relevant electrical safety and EMC regulations are authorized to work on the electrical installation.
- ▶ This product must not be modified or converted arbitrarily.

NOTICE

Risk of electromagnetic disturbance

Voltages and currents can induce a multitude of electromagnetic fields and interference signals. Installations that do not comply with the EMC regulations can interfere with other equipment and the environment in general.

- ▶ Use shielded cables and connections for the interfaces in interference-prone environments.

Electrical safety

The leak detector is Class 1 equipment and therefore must be earthed.

- ▶ Make sure the main switch/circuit breaker is set to **O**.
- ▶ Connect the power supply to the connector using the power cable supplied with the detector (see chapter "Connection interface").
- ▶ See chapter "Technical characteristics".

5.8 Part/installation to be tested connection

NOTICE

Risk of deterioration of parts or installations

There is a risk of deterioration for parts or installations connected to the leak detector vacuum circuit.

- ▶ Make sure that the parts or installations connected to the detector's pump inlet withstand a negative pressure of $1 \cdot 10^3$ hPa in relation to the atmospheric pressure.
- The maximum permitted weight at the detector's inlet must be no more than 18 kg and the maximum torque must be 25 N · m.
- ▶ Remove the blanked-off flange that covers the detector's inlet port and save it for reuse during storage or transport.
- ▶ Use pipes with a diameter equal to the diameter of the detector's inlet. The pipes should be as short as possible and completely sealed.
- ▶ Connect the part or the installation to be tested using the connection accessories available in the product catalogue.
- ▶ Connect the part or the installation to be tested using the flexible pipeworks. Never use rigid or flexible plastic pipework (compressed air style tube).

6 Commissioning

6.1 Detector start-up

1. Connect the main power supply cable.
2. Set the main switch/circuit breaker to **I**.
3. For first start-up: set the language, unit, date and time (the user can modify these settings at a later time).
4. Wait for the detector to enter "Stand-by" mode.

Start-up after an extended shutdown

If the detector has been stored or has not been used, start-up time is longer than if it is in regular use.



After a shutdown of the detector of more than 3 months, it is advisable to start up the detector 24 hours before its use.

6.2 Detector powering off



1. Set the switch/circuit breaker to **O**.
2. Disconnect the mains power cable.
3. Wait 5 minutes before working on the detector, removing the cover or moving the detector.

Pump stop due to power failure

When there is a mains power failure, the detector shuts down: it switches on again automatically when power is restored.

6.3 Familiarise yourself with the control panel

Control panel description (see chapter "Control panel description").

- ▶ Press  several times to familiarise yourself with the application screens.
- ▶ Press  several times to see the 2 levels of function keys available.
- ▶ At each level, press  or the control panel function key to access the function.

7 Operation

7.1 Use conditions

WARNING

Risk of injury due to the use of hydrogen as tracer gas

Hydrogen can be used as a tracer gas for leak detection. Depending on its concentration, in the worst scenario, there may be a risk of explosion.

- ▶ Never use a tracer gas with a hydrogen content greater than 5%.
- ▶ Use hydrogenated nitrogen as a tracer gas: mix of 95% N₂ and 5% H₂.

NOTICE

Leak detector ventilation

In cases of poor ventilation, there is a risk of deterioration of the detector's internal components by heating.

- ▶ Comply with the ambient operating temperature.
- ▶ Do not obstruct the ventilation grids.
- ▶ Ventilation grids should be cleaned regularly.
- ▶ Leave a free space of at least 10 cm all around the leak detector.
- ▶ Store nothing under the detector.

NOTICE

Risk of deterioration from solid particles

The tested applications may generate solid particles.

It is recommended in this case to protect the detector inlet (inlet port).

- ▶ Install a filter at the detector inlet (see chapter "Accessories").

Environmental conditions: see chapter "Technical characteristics".

7.2 Prerequisites for optimizing use

To optimize the use of the detector:









- ▶ Test only clean, dry parts/installations with no trace of water, vapor, paint, detergent or rinsing products.
- ▶ Check that the connected part/installation is impervious to tracer gas.
- ▶ Make sure that the test area is not polluted by the tracer gas.
- ▶ No message should be displayed.
 - No  pictograph is displayed on the main screen.
 - If the pictograph is displayed, read the message and address it.
- ▶ Perform leak detector calibration.

Before each switched on:

- ▶ Become familiar with the safety instructions.
- ▶ Check that all the connections are correct.

7.3 Operation monitoring

During operation, the user is notified of an incident on the detector control panel.

Type of fault	Control panel	
Warning	Display of fault.  	Click on the pictogram  to display the fault.
Error	Display of fault.  	Click on the pictogram  to display the fault.
Critical error	Display of the message "Critical error - E244".  	Contact our service center.

7.4 Test Start/Stop

Prerequisites

See chapters "Switching the detector on" and "Test launched automatically upon start-up"

Test method

The test method is chosen depending on the part to be tested.

For more information about leak detection test methods, see **Leak detector compendium** on the www.pfeiffer-vacuum.com website.

There are 2 possible test methods:

- Hard Vacuum
- Sniffing

Hard vacuum test

The test can also be started using a remote control (accessory): see the remote control operating instructions.

1. Select the 'Hard Vacuum' test method (see chapter "Test method").
2. Select the test mode (see chapter "Test mode").
3. Set the reject point if necessary (see chapter "Hard vacuum reject point").
4. Put the detector on 'Stand-by' mode.
 - In 'Stand-by' mode, the leak rate displayed corresponds to the detector's background.
5. Prepare the part/installation to be tested (see chapter "Part/installation to be tested connection").
 - Spray method
 - Connect the part/installation to be tested to the leak detector inlet port.
 - Evacuate the air from the part/installation to be tested.
 - Bombing method
 - Place the part to be tested in a pressurization chamber with the tracer gas.
 - Remove the part to be tested from the chamber and put it in the test chamber connected to the leak detector inlet port.
6. Begin the test by pressing the **START/STAND-BY** button.
 - Spray method
 - Spray the tracer gas on the points on the part that are likely to leak.
7. The various test steps are displayed.

When the detector has reached the most sensitive test mode, wait for the measurement to stabilize: the measurement displayed corresponds to the measured leak rate.
8. Stop the test by pressing the **START/STAND-BY** button.

Sniffing test mode

1. Prepare the part/installation to be tested.
2. Select the 'sniffing' test method (see chapter "Test method").
3. Depending on the model of the detector, select the model of the sniffer probe used (see chapter "Type of probe").
4. Set the reject point if necessary (see chapter "Sniffing reject point").
5. Put the detector on 'Stand-by' mode.
6. Connect the sniffer probe (accessory).
7. Begin the test by pressing the **START/STAND-BY** button.
8. Then run the sniffer probe slowly over the areas of the part to be tested that may leak: the leak rate displayed varies when a leak is detected (quantitative value of the measured leak rate).
9. Stop the test by pressing the **START/STAND-BY** button.

7.5 Test launched automatically upon start-up

This function is used to automatically launch the first test after the detector start-up phase. If the function is enabled, the first test starts automatically as soon as the detector start-up phase is completed. Subsequent tests are launched by the user.

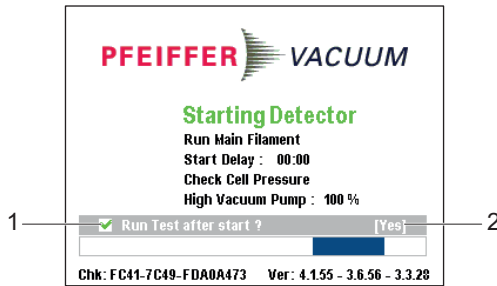

- 1 Check box for the 'Run Test after start?' message 2 Activation/deactivation of the function

1. Ensure that the inlet is connected before starting the function.
2. During the detector start-up phase, check (✓) the displayed message 'Run Test after start?', then click on **[Yes]** to enable the function.
 - Click on **[No]** to not enable the function.
 - The question will be asked each time the leak detector is switched on. The last selection made is not saved.

7.6 Calibration

Calibration helps ensure that the leak detector is correctly adjusted to detect the tracer gas selected and display the correct leak rate.

A calibrated leak is used to calibrate the leak detector.

The leak detector should be calibrated with a calibrated leak of the same type as the tracer gas used.

i

Detector calibration

20 minutes after switching it on, the detector suggests that the user perform a calibration. For correct use of the detector and to optimize the accuracy of the measurement, **this calibration must be performed.**

It is recommended to perform a calibration:

- at least once a day,
- for intense operation: start calibration at the beginning of each work session (e.g. work in shifts, every 8 hours),
- if it is uncertain whether the detector is working properly.



Tracer gas or test method setting modification

The selected test method and tracer gas have an impact on the calibration.

It is mandatory to perform a calibration of the detector if one of the following parameters is modified:

- test method (hard vacuum or sniffing)
- tracer gas (^4He , ^3He or H_2)

Internal calibrated leak

The internal calibrated leak is specifically designed for the leak detector. It is composed of:

- a reservoir filled with ^4He tracer gas (no internal calibration with other tracer gases),
- a temperature sensor (to take into account the effect of temperature on the leak rate),
- an integrated diaphragm (to calibrate the leak rate),
- an identification label (identical to the identification label of an external calibrated leak).

The calibrated leak is supplied with a calibration certificate.



Use a calibrated leak in the range of $\approx 10^{-7}$ mbar · l/s ($\approx 10^{-8}$ Pa · m³/s).



In the case of intensive use of the detector, a spare internal calibrated leak is recommended. By default, the detector can be calibrated with an external calibrated leak.

External calibrated leak

The operator must use a calibrated leak containing the tracer gas selected (^4He , ^3He or H_2).

There are several types of external calibrated leaks, with or without reservoir, with or without valve, covering several ranges of leaks.

The manufacturer does not provide calibrated leaks in ^3He and H_2 .



The choice of external calibrated leak depends on application requirements: use a calibrated leak from the same leak rate range as the leak to be measured.

7.6.1 Calibration in hard vacuum test mode with internal calibrated leak

Internal calibrated leak (see chapter “Calibration”).

Calibration can be performed when the detector is in test mode.

1. Allocate a function key to **[Auto.Cal]** (see chapter “Function keys”).
2. Check the leak settings (leak rate corrected for temperature and time as needed) (see chapter “Calibrated leak”).
3. Press the **[Auto.Cal]** function key to start a calibration.

7.6.2 Calibration in hard vacuum test mode with external calibrated leak

External calibrated leak (see chapter “Calibration”).



Calibration with an external calibrated leak is advised when the reject point is far from the internal calibrated leak value.

1. Allocate a function key to **[Auto.Cal]** (see chapter “Function keys”).
2. Configure the following settings:
 - test method: hard vacuum (see chapter “Test method”).
 - type of calibrated leak: external (see chapter “Calibrated leak”).
 - calibration: operator (see chapter “Leak Detection: Calibration”).
3. Check the setting for the external calibrated leak used (see chapter “Calibrated leak”).
4. As needed, correct the parameters of the external calibrated leak used (see the label for the calibrated leak or the calibration certificate).
5. Select the tracer gas for the external calibrated leak (see chapter “Calibrated leak”).
6. Place the external calibrated leak on the detector’s inlet port.
7. Check that the detector is in ‘Stand-by’ mode.

8. Press the **[Auto.Cal]** function key to start the calibration.
9. Follow the instructions given by the leak detector.
 - Press **[Next]** to move to the next step.

At the end of the calibration, the detector returns to 'Stand-by' mode.

7.6.3 Calibration in hard vacuum test mode with a pumping system in parallel

When the leak detector is connected to an installation equipped with its own pumping system, only part of the leak will be measured by the leak detector. Calibration gives a direct reading of the leak rate by taking into account the loss of tracer gas of the leak pumped by the pumping unit.

Calibration is performed via the Correction function ('Autocor').

Correction must be performed when the leak detector is already calibrated with its internal calibrated leak.

When an external calibrated leak is used, it is recommended to take into account the calibration date and temperature effect for calculating the target value from the calibrated leak value featured on its identification label.

Corrected leak rate = target value = measured leak value x correction factor

1. Allocate a function key to **[Correction]** (see chapter "Function keys").
2. Select the 'hard vacuum' test method (see chapter "Test method").
3. Press the **START/STAND-BY** button to start a test.
4. Press the **[Correction]** function key.
 - if the value of the correction factor to be applied is known:
 - Press **[Value]** and configure the correction factor to be applied. The correction factor is the coefficient to be applied to the measured leak rate.
 - Press **[Return]** to exit the function.
 - If the value of the correction factor is unknown:
 - Press **[Auto Cor.] [Target]** and configure the target leak rate.
 - Press **[Start]** to make the correction.
5. Press **[Return]** to exit the function.
6. Press **[Reset]** to reset the correction factor to 1.

The value of the correction factor is calculated automatically.

The **COR** indicator light is displayed on the control panel when the value of the correction factor is not 1.

The digital display takes into account the applied correction factor.

The bargraph display does not take into account the applied correction factor.

7.6.4 Calibration in sniffing test with internal calibrated leak

Internal calibrated leak (see chapter "Calibration").

Calibration can be performed when the detector is in 'Stand-by' mode.

This calibration only calibrates the detector, not the entire measurement chain (detector + sniffer probe).

- ▶ Identical to the procedure in hard vacuum test mode (see chapter "Calibration in hard vacuum test mode with internal calibrated leak").

7.6.5 Calibration in sniffing test with external calibrated leak

External calibrated leak (see chapter "Calibration").

1. Allocate a function key to **[Auto.Cal]** (see chapter "Function keys").
2. Configure the following settings:
 - test method: sniffer (see chapter "Test method").
 - type of calibrated leak: external (see chapter "Calibrated leak").
 - calibration: operator (see chapter "Leak Detection: Calibration").
3. Select the tracer gas for the external calibrated leak (see chapter "Tracer gas").
4. Verify the setting for the external calibrated leak used (see chapter "Calibrated leak").

Correct the temperature, month and year if necessary.
5. Press the **[Auto.Cal]** function key to start the calibration.
6. Follow the instructions given by the leak detector.
 - Press **[Next]** to move to the next step.

Adaptor for external calibrated leaks

A DN 16 ISO-KF or DN 25 ISO-KF adaptor helps calibrate the detector with an external calibrated leak in sniffing test mode (with Standard sniffer probe only).

Adaptor part number (see chapter “Accessories”).

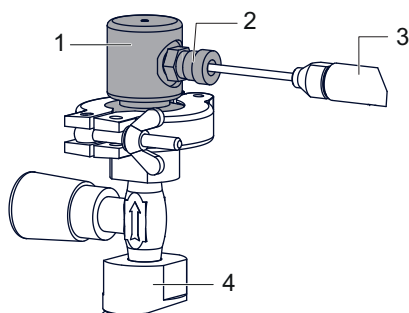

- | | |
|--|-------------------|
| 1 DN 16 ISO-KF or DN 25 ISO-KF adaptor | 3 Sniffer probe |
| 2 Fixing screws | 4 Calibrated leak |

1. Attach the adaptor to the external calibrated leak used for the calibration with a centering ring and a clamp.
2. Press the **[Auto.Cal]** function key to start a calibration.
3. Place the sniffer probe in the calibration port.
4. Tighten the fixing screw.
5. Follow the instructions given by the leak detector.
 - Press **[Next]** to move to the next step.
6. Loosen the fixing screw.
7. Remove the sniffer probe from the calibration port.
8. Follow the instructions given by the leak detector.
 - Press **[Next]** to move to the next step.
9. Wait 10 s (at least) before reading the leak rate.

7.6.6 Calibration in sniffing test on concentration

Concentration = volume at atmospheric pressure filled with a gas mixture for which the tracer gas content is known.

Calibration on concentration can only be carried out in sniffing test mode, with the detector in ‘Stand-by’ mode.

Before launching this function, make sure that the leak detector is in an environment free of tracer gas pollution.

1. Allocate a function key to **[Auto.Cal]** (see chapter “Function keys”).
2. Configure the following settings:
 - test method: sniffer (see chapter “Test method”).
 - calibration: operator (see chapter “Leak Detection: Calibration”).
3. Select the tracer gas for the concentration (see chapter “Tracer gas”).
4. Press the **[Auto.Cal]** function key to start a calibration.
5. Follow the instructions given by the leak detector.
 - Press **[Next]** to move to the next step.

At the end of the calibration, the detector returns to ‘Stand-by’ mode.

7.7 Zero Function

The zero function is used to identify very small variations in the leak rate in the ambient background.

Zeroing

Configuration (see chapter “Zero activation”).

Over time, there may be a deviation in the leak rate display. Zeroing must be performed regularly in the following cases:

- when the detector’s background value increases,
- before performing a precise measurement.

1. Allocate a function key to **[Zero]** (see “Function keys”).
2. Press the **[Zero]** button.

7.8 Touch screen

The touch screen is interfaced with the detector and is used to:

- display information about the test,
- access the available functions,
- set the detector's parameters.

4 application screens are provided to the user to access this data.

The user can hide and/or change some screens in the loop (see chapter “Application Windows”).

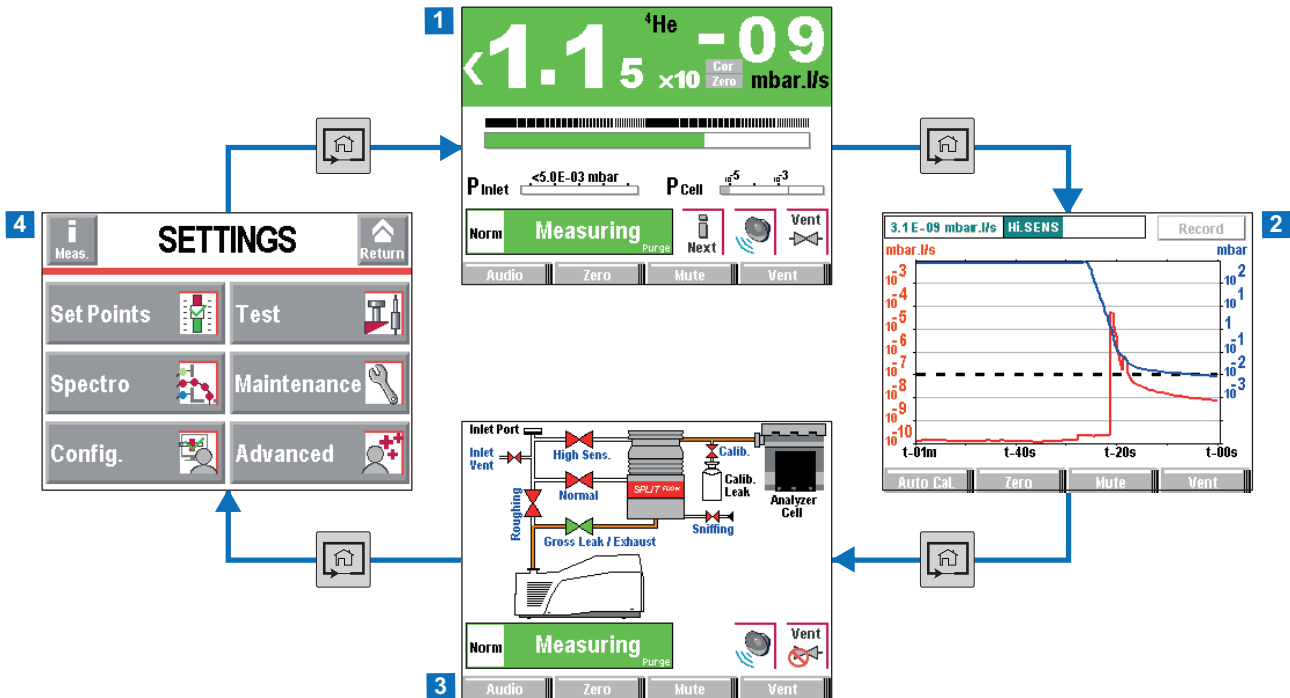

Example of each application screen

1	“Main” Screen (Standard)	Information about the current test
2	“Graph” screen	Monitoring and recording the leak rate and/or the inlet pressure
3	“Vacuum circuit” screen	Schematic diagram of the detector and the status of the valves
4	“Settings” screen	Detector parameters

The contents of the screens are provided as an example: depending on the detector settings, the display may be different.

- ▶ Remove the film that protects the touch screen upon delivery.
- ▶ Use the touch screen manually without using hard objects such as pens, screwdrivers, etc.
- ▶ Use the RS-232 serial link to control/set the detector if the touch screen is out of service (broken screen).

Contrast - Brightness - Screen Saver

See chapter “Screen Settings”.

Screenshot

- ▶ To take a screenshot, allocate a function key to **[Screen Copy]** (see chapter “Function keys”).

Access to the application screens and the Settings menu

Access to the application screens and the Settings menu can be permitted or forbidden.

A user level can be allocated to the user.

- ▶ To permit/forbid access to the application screens, see chapter “Application windows” or chapter “Password.”
- ▶ To permit/forbid access to the Settings screen and user level attribution, see chapter “Access - Password.”

7.8.1 Navigation

Symbols

	Function deactivated (OFF)
	Function activated (ON)
	Authorized access without password
	Access locked: access with password
	"Pixelated" key: access prohibited for the product
	"Grey" key: access settings or function
	"White" key: key not customizable, for information
	"Measurement information" key: to display the measured leak rate
	Arrows for navigating within the menus
	Access to the error/warning window
	Value selected is customizable
	Keys for setting the values
	Moving to the next function/screen/parameter
	Return to the previous display
	Return to the previous display with confirming the changes made
	Return to the previous display without confirming the changes made
	Deleting the selected file

7.8.2 Main screen

Information about the test.

- ▶ Access the main screen by pressing repeatedly on the key

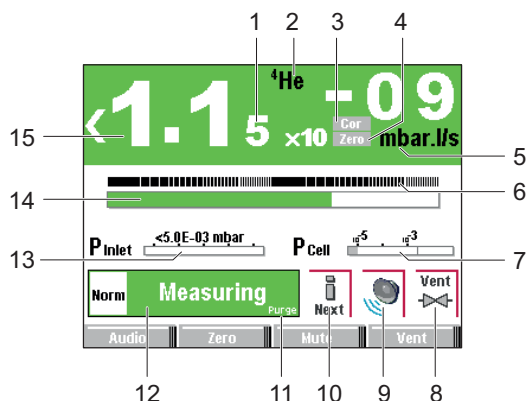

Item	Function
1	Display 2 nd digit
2	Tracer gas
3	COR indicator: correction factor applied
4	'Zero' function status indicator
5	Leak rate unit
6	Zero function 2 decade bargraph display
7	Cell or external gauge pressure bargraph display
8	'Inlet vent' function status indicator
9	'Mute' function status indicator
10	Indicator  : error/warning message to be consulted
11	'Purge' enabled function status indicator
12	Current status of the detector Detection mode
13	Detector inlet pressure bargraph display (unit consistent with the leak rate unit)
14	Leak rate Bargraph display (adjustable scale) (color depends on test results)
15	Leak rate digital display The color of the screen varies depending on the test result: <ul style="list-style-type: none"> • green screen: measured leak rate below the reject point • red screen: measured leak rate above the reject point gray screen: detector in stand-by

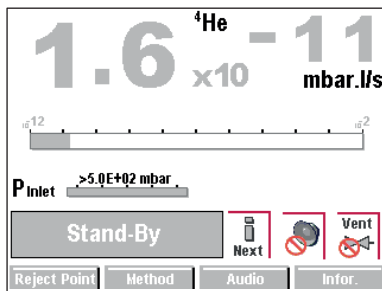

Main screen in 'Stand-by' mode

7.8.3 Graph screen

Monitoring and recording the leak rate and/or the inlet pressure.

- Access to graph screen by pressing repeatedly on the key .

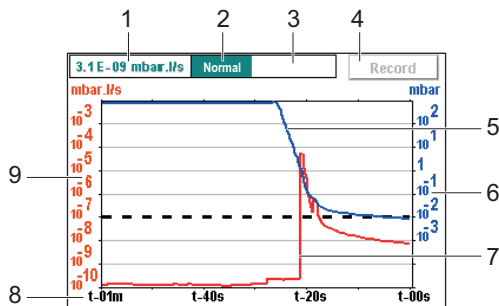

Item	Function
1	Digital display of leak rate
2	Current status of the detector Detection mode

1) Adjustable scale by pressing the graph

Item	Function
3	COR indicator: correction factor applied ZERO indicator: zero function activated
4	Recording a plot
5	Inlet pressure plot (in blue)
6	Inlet pressure scale (in blue) ¹⁾
7	Plot of the tracer gas leak rate (in red)
8	Time scale ¹⁾
9	Scale of the tracer gas leak rate (in red) ¹⁾

1) Adjustable scale by pressing the graph

7.8.4 Graph screen: graph parameters

► Press on the screen to access the graph parameters.

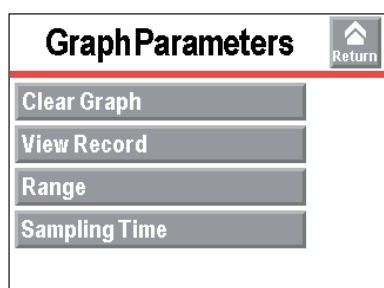

Access: Press on the screen to access the graph parameters.

Clear Graph	To be launched Graph clearing (see chapter "Graph screen: Graph clearing").
View Record	To be set Saving and viewing of a recording (see chapters "Graph screen: saving a recording" and "Graph screen: viewing a recording").
Range	To be set Configuration of the graph scales (see chapter "Graph screen: scales").
Sampling Time	To be enabled Recording a graph (see chapter "Graph screen: recording a graph").

7.8.5 Graph screen: graph clearing

► Press on the screen to access the graph parameters.

Clearing the current window

1. Press [**Clear Graph**].
2. Validate the message.

Clearing the current window does not delete the current recording or recordings already made.

Clearing the current recording

1. Press [**View Record**].
2. Press [**Clear**].
3. Validate the message.

7.8.6 Graph screen: recording a graph

Recording makes it possible to store the measurements taken during the test in the control panel memory: **it will not save these measurements.**

During recording, all of the leak detector functions are available.

If the memory is not cleared between two recordings, ([Clear] (see chapter “Graph screen: Graph clearing”)), all successive recordings will follow each other on the same stored plot. A (Δ) cursor indicates the change in recording.

After the detector is switched off (cut off at the mains or by the operator), the recordings already made are stored in the memory. For the next recording, the operator will have to specify:

- if the new recording is to be added to the recordings in the memory [OK].
- if the new recording is to delete and replace the recordings in the memory [Cancel].

Configuration

Press the graph, then [Record], to modify the recording parameters		Choice - Setting limit ¹⁾
Duration	To be set Recording duration See details below	0.2 s – 30 s
Capacity	Read only Total recording time according to configured recording duration See details below	-

1) Initial setting: see chapter “Tree diagram of the Settings menu”

Recording duration detail

Duration	Maximum capacity	File size
0.2 s (minimum)	6 hours 33 minutes	≈ 7 Mo
30 s (maximum)	983 hours 32 minutes	

1. Configure the recording parameters.
2. Configure the graph parameters (see chapter “Graphic screen: scales”).
3. Press [Record] to start recording.
 - None of the measurements displayed on the plot before the recording starts will be recorded.
4. Press [Stop] to stop recording.
5. Press the graph and [View Rec.] to see the recording.

Recording example

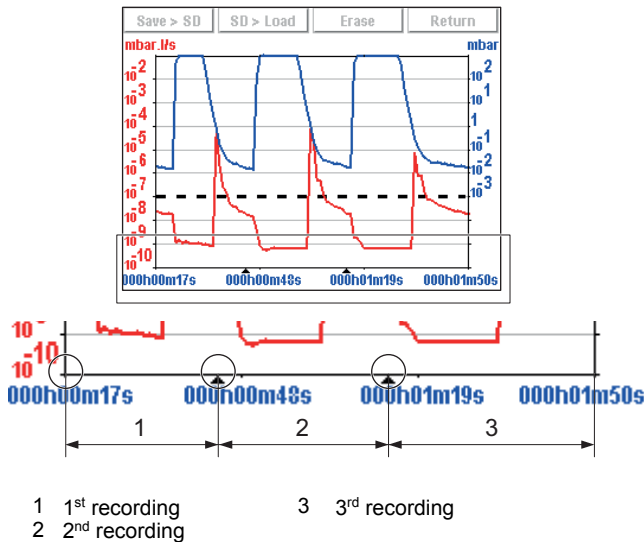

When the memory is full and a recording is in progress, recording is automatically stopped. The [Record] key is replaced by the [Mem. full] key.

7.8.7 Graph screen: scales

- ▶ Press the graph and [Range] to modify the graph parameters.

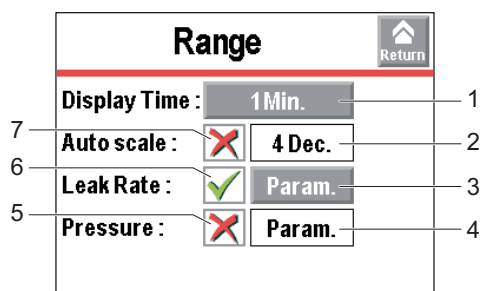

1	Period of time displayed on the screen
2	Setting the automatic scale
3	Setting the measured leak rate scale
4	Setting the inlet pressure scale
5	Displaying/Hiding the inlet pressure
6	Displaying/Hiding the measured leak rate
7	Activating/Deactivating the automatic scale

Access: Press the graph and [Scale] to modify the graph parameters.		Choice - Setting limit ¹⁾
Display Time	To be set Period of time displayed on the screen	Rapid / 1 min / 2 min / 3 min / 6 min / 12 min / 30 min / 1 h / 2 h
Auto scale	To be enabled The automatic scale is used to display the measured leak rate centered on 2 or 4 decades. The scale varies according to the leak rate measured. When the automatic scale is activated, the scales set for the leak rate and pressure are no longer taken into account.	Activated Deactivated
	To be selected Setting the automatic scale Example: leak rate = $5 \cdot 10^{-7}$ mbar · l/s ($5 \cdot 10^{-8}$ Pa · m ³ /s) <ul style="list-style-type: none"> automatic scale 2 decades: scale from $1 \cdot 10^{-6}$ to $1 \cdot 10^{-8}$ mbar · l/s ($1 \cdot 10^{-7}$ to $1 \cdot 10^{-9}$ Pa · m³/s) automatic scale 4 decades: scale from $1 \cdot 10^{-5}$ to $1 \cdot 10^{-9}$ mbar · l/s ($1 \cdot 10^{-6}$ to $1 \cdot 10^{-10}$ Pa · m³/s) 	2 decades 4 decades
Leak Rate	To be enabled Displaying/Hiding the measured leak rate	Activated Deactivated
	To be set Setting the leak rate scale (If 'automatic' scale is deactivated)	Decade Max Decade Min
Pressure	To be enabled Displaying/Hiding the inlet pressure	Activated Deactivated
	To be set Configuration of the maximum decade for the inlet pressure	Decade Max

1) Initial setting: see chapter "Tree diagram of the Settings menu"

7.8.8 Graph screen: saving a recording

This function is used to save the most recent recording on a SD card to be played back/analyzed later on a computer. Saving is not automatic.

It is possible to save a screenshot of the recording (.bmp) or to generate a file (.txt) with all the measurements taken. The .txt file allows subsequent processing: the 'tab' separator is used by default.

1. Press the screen and on [View Rec.] [Save > SD].
2. Choose the file type.
3. Name the file and save it.

The saved .bmp and .txt files include only the measurement points displayed on the screen:

- to include all points, you must be positioned on the relevant plot (without zooming).
- if a zoom was carried out before saving, the zoom will apply only to the points of the selected area.

If the saved recording is made up of several consecutive recordings:

- The (Δ) cursor indicates each change of recording on .bmp files.
- “B.P. # xx” will be noted at the end of the last line of each recording in the .txt files.

The .bmp files can be displayed on the control panel screen.

The .txt files can only be opened from a computer: they cannot be viewed from the control panel.

7.8.9 Graph screen: viewing a recording

At any time, a saved file can be viewed or a zoom can be performed on it, without stopping an ongoing recording.

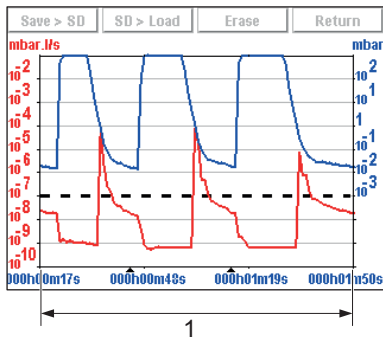

1 Total recording time

- ▶ Press the graph and **[View Record]** to view the recording made since the last recording was deleted.
 - If no plots have been made, the message “Memory empty” is displayed.

Zoom in

Zoom in available only for a recording.

Several successive zooms are possible (except in the same decade).

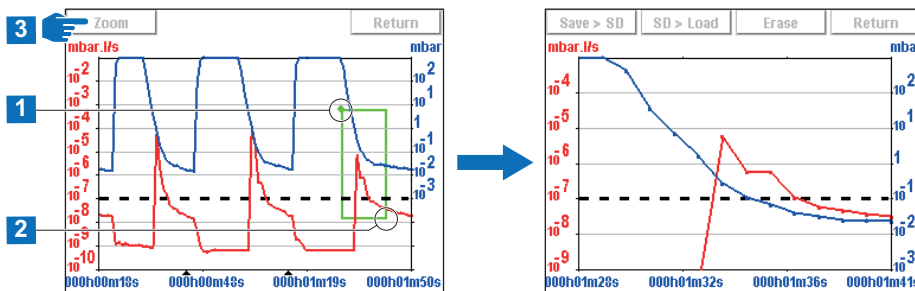

1. Press the graph.
2. Press **[View Rec.]**.
3. Define the area to be enlarged by selecting 2 points.
4. Press **[Zoom]**: the enlarged area is displayed.



If necessary, adjust the area to be enlarged by dragging the corners or sides with finger.

Zoom out

Zoom out available only for a recording.

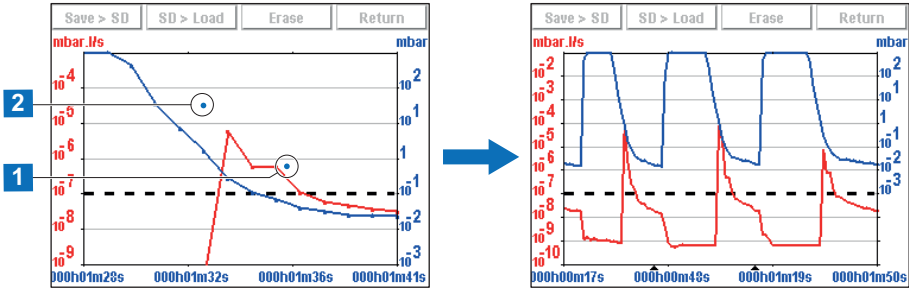

1. Press twice on the zoom to return to the original graph.
 - The 2nd press should always be done to the left of the 1st on the screen: see the example above.

Measurement

Exact measurement of a point, only available on a recording.

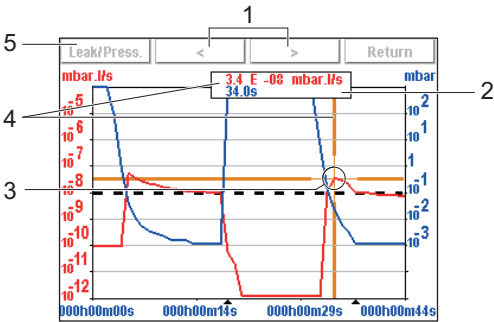

- | | |
|--|---|
| <ol style="list-style-type: none"> 1 Navigation between next/previous recorded points 2 Displaying the tracer gas leak rate (in red) or the inlet pressure (in blue) 3 Marker indicating the selected point | <ol style="list-style-type: none"> 4 Moment the measurement took place in relation to the start of the recording 5 Selecting the display of the leak rate or the inlet pressure |
|--|---|
1. Select the point to measure.
 2. Press **[Measure]**: the exact measurement of the selected point is displayed.



To have the exact values of all the measurements, save the recording in a .txt file.

7.8.10 Settings screen

The Settings screen allows the user to access 6 menus for configuring the product to user specifications (see chapter “Settings”).

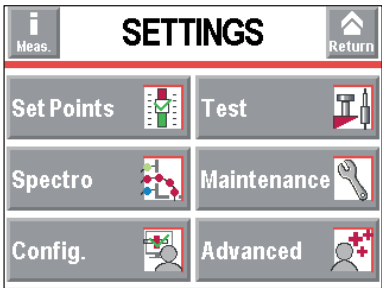

Access to Settings screen:

- by pressing repeatedly on the key ,
- by pressing 2 keys + simultaneously on the control panel.



It is possible to password lock access to the Settings menus while keeping some functions available via the function keys (see chapter “Application windows”).

Temporary access to a locked menu

Temporary access: after returning to the main screen, the menu is once again locked.

- ▶ See chapter “Access - Password”.

7.8.11 Vacuum circuit screen

The vacuum circuit corresponds to the detector’s schematic diagram.

The vacuum circuit displayed is specific to each detector model.

The vacuum circuit varies depending on the status of the valves, but does not make it possible to manage the valves.

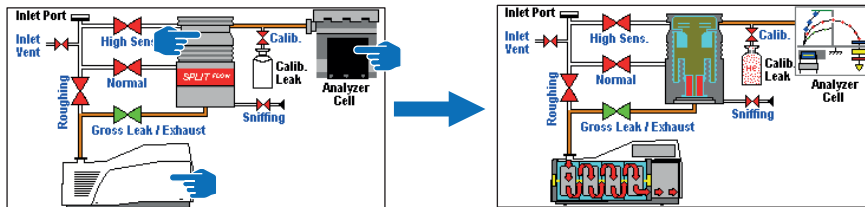

Example vacuum circuit

Component	Description
Red valve	Valve closed
Green valve	Valve open
Pumps	Press the component to display the operating principle.
Analyzer cell	

- ▶ Access the Vacuum circuit screen by pressing repeatedly on the key .

7.8.12 ‘Measurement’ window

1. Press the **[Measure]** key to display the window.
2. Press and drag the window to move it on the screen.

[Measure] key and the corresponding window

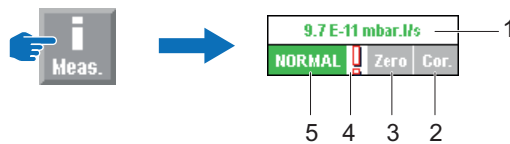

Item	Function
1	Digital display of leak rate The display color varies depending on the results of the test: <ul style="list-style-type: none"> • green screen: measured leak rate below the reject point • red screen: measured leak rate above reject point
2	COR indicator: correction factor applied
3	Zero indicator: zero function activated
4	Error information indicator Indicator !: error/warning message to be consulted
5	Detection mode

8 Settings

The Settings screen allows the user to access 6 menus for configuring the product to use specifications. See chapter “Settings Screen”.

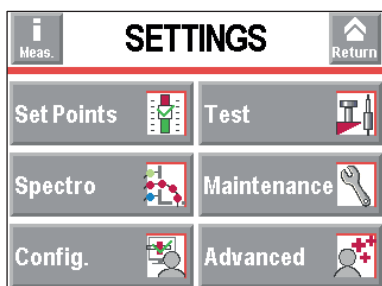

Functions by menu

SET POINTS menu

- Audio alarm
- Digital voice
- Pollution function
- Hard vacuum reject point
- Sniffing reject point
- Other set points
- Other pressure set points

TEST menu

- Test method
- Correction factor
- Test mode
- Probe type
- Automatic cycle end
- Air inlet
- Memo function
- Zero Activation
- Bypass option
- Regeneration
- Massive mode

SPECTRO menu

- Tracer gas
- Filament parameters
- Calibrated leak

MAINTENANCE menu

- Detector
 - Timers
 - Detector information
 - Pump information
 - Event history
 - Calibration history
 - Burn-in
 - Secondary pump and analyzer cell maintenance
 - Last maintenance
-

Functions by menu

CONFIGURATION menu

- Unit/Date/Language
- Function keys
- Application windows
- Screen settings
- Access - Password

ADVANCED menu

Advanced functions reserved for specific detector uses.

- Leak Detection: Start-up timer
- Leak Detection: Background suppression
- Leak Detection: Crossover pressures
- Leak Detection: Calibration
- Leak Detection: Analyzer cell
- Leak Detection: Internal Pirani gauge calibration
- Leak Detection: External gauge
- Leak Detection: Purge valve
- Input/Output: Serial link 1 and Serial link 2
- Input/Output: I/O connector
- SD card menu
- Service

8.1 Set points menu

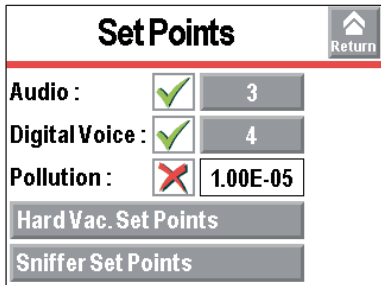

8.1.1 Audio alarm and digital voice

This menu is used to configure the sound volumes.

Access: Settings Screen + Menu [Setpoints]		Choice - Setting limit ¹⁾
Audio alarm	To be enabled	Enabled
	The audio alarm informs the user that the reject point has been crossed.	Disabled
	To be set Level 9 = 100 dBA	0 – 9
Voice	To be enabled	Enabled
	The digital voice informs the user about the status of the detector or actions to be carried out.	Disabled
	To be set Level 9 = 100 dBA	0 – 9

1) Initial setting: see chapter “Tree diagram of the Settings menu”



For quick access from the main screen, configure a function key to **[AUDIO]** (see chapter “Function keys”).

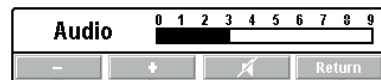



For quick access from the main screen, configure a function key to **[VOICE]** (see chapter “Function keys”).

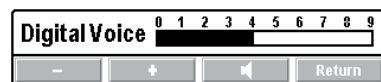

From the main screen, use the **[MUTE]** key to simultaneously cut off the sound alarm and the digital voice.

On the control panel, the red cross on the pictograph indicates that the “Mute” function is enabled.

8.1.2 Pollution function

This menu enables protection of the leak detector from pollution by preventing too much of the tracer gas coming from the leak from penetrating the detector.

When the set pollution threshold is exceeded:

- an audible signal is emitted to indicate that the detector is in 'Standby' mode
- a message (W222) is displayed informing that the 'Pollution' function is activated.

Access: Settings Screen + [Setpoints] Menu		Choice - Setting limit ¹⁾
Pollution	To be enabled	Enabled Disabled
	To be set We recommend setting the pollution set point to a maximum of 4 decades above the reject set point. If the leak rate rapidly increases above the pollution set point, the cycle stops automatically and the leak detector returns to Stand-by mode.	$1 \cdot 10^{+19}$ – $1 \cdot 10^{-19}$

1) Initial setting: see chapter “Tree diagram of the Settings menu”



Useful function if the part or installation to be tested is likely to have gross leaks.

8.1.3 Hard vacuum reject point

This menu is used to define the hard vacuum reject point.

The reject point is the acceptance threshold for tested parts.

Access: Settings Screen + Menu [Set Points] [Hard Vacuum Set Points]		Choice - Setting limit ¹⁾
Reject point	To be set for each tracer gas The reject point is the acceptance threshold for parts. <ul style="list-style-type: none"> • Measured leak rate < reject point: part accepted • Measured leak rate > reject point: part rejected Display of the test results: <ul style="list-style-type: none"> • Leak rate below reject point <ul style="list-style-type: none"> – Screen/Bargraph: green – Bargraph: white – Graph: red line • Leak rate greater than the reject point <ul style="list-style-type: none"> – Screen: red – Bargraph: white – Graph: red line 	$1 \cdot 10^{+06}$ – $1 \cdot 10^{-13}$

1) Initial setting: see chapter “Tree diagram of the Settings menu”



For quick access from the main screen, configure a function key to **[REJECT POINT]** (see chapter “Function keys”).



8.1.4 Sniffing reject point

This menu is used to define the reject set point in sniffing.
 The reject point is the acceptance threshold for tested parts.

Access: Settings Screen + Menu [Set Points] [Sniffing Set Points]		Choice - Setting limit ¹⁾
Reject point	To be set The reject point is the acceptance threshold for parts. <ul style="list-style-type: none"> Measured leak rate < reject point: part accepted Measured leak rate > reject point: part rejected Display of the test results: <ul style="list-style-type: none"> Leak rate below reject point <ul style="list-style-type: none"> Screen/Bargraph: green Bargraph: white Graph: red line Leak rate greater than the reject point <ul style="list-style-type: none"> Screen: red Bargraph: white Graph: red line 	$1 \cdot 10^{+06} - 1 \cdot 10^{-12}$

1) Initial setting: see chapter "Tree diagram of the Settings menu"



For quick access from the main screen, configure a function key to **[REJECT POINT]** (see chapter "Function keys").



8.1.5 Probe clogged threshold

This menu is used to set the probe clogged threshold to verify that the sniffer probe (accessory) is operational.

When the probe flux is below the 'Probe clogged' threshold, the icon  is displayed to make the user aware of this information.

The value of the 'Probe Clogged' threshold must always be greater than the value of the "Display Value Min." threshold.

Access: Settings Screen + Menu [Set Points] [Sniffing Set Points]		Choice - Setting limit ¹⁾
Probe Clogged	To be set	
	With standard sniffer probe The threshold unit is the unit set for the detector.	$1 \cdot 10^{+19} - 1 \cdot 10^{-19}$
	With Smart sniffer probe The threshold unit is still 'sccm'.	0 – 9999

1) Initial setting: see chapter "Tree diagram of the Settings menu"

8.1.6 Other set points

This menu is used to provide 4 additional hard vacuum reject points managed by the communication interface.

Prerequisite(s)

- Detector equipped with 37-pin I/O communication interface (option/accessory).

Access: Settings Screen + Menu [Set points] [Other Pressure Set pts]		Choice - Setting limit ¹⁾
Reject point 2/3/4/5	To be set	$5 \cdot 10^{-5} - 3 \cdot 10^{+2}$

1) Initial setting: see chapter "Tree diagram of the Settings menu"

8.1.7 Other pressure set points

This menu is used to provide 2 additional pressure set points managed by the communications interface (see the operating instructions for the interface (see chapter "Applicable Documents").

Prerequisite(s)

- Detector equipped with 37-pin I/O communications interface (option/accessory).
- Installation equipped with an external gauge (customer's responsibility)

Access: Settings Screen + Menu [Set points] [Other Pressure Set pts]		Choice - Setting limit ¹⁾
Pressure reject point 1/2	To be set Pressure reject point 1 must always be greater than pressure reject point 2	$5 \cdot 10^{-5} - 3 \cdot 10^{+2}$

1) Initial setting: see chapter "Tree diagram of the Settings menu"

8.2 Test menu

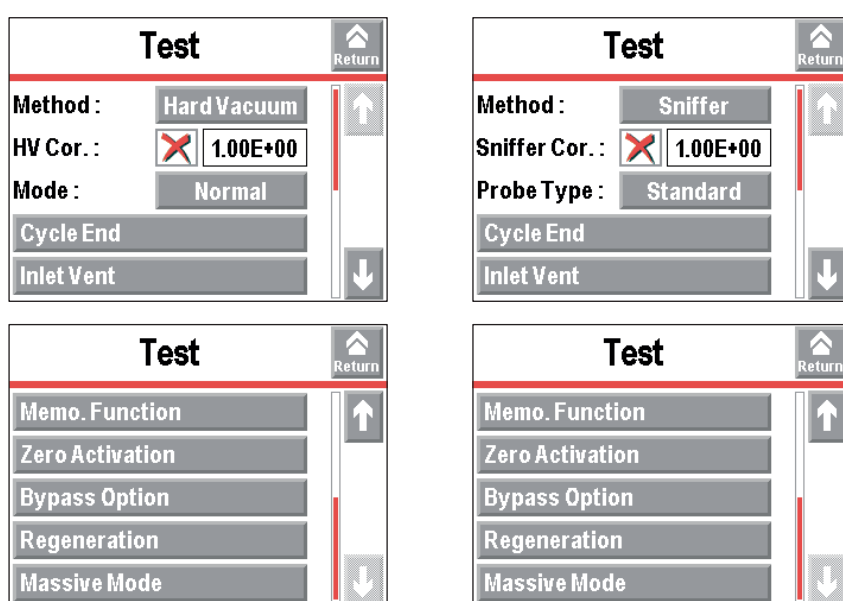

1

2

1 Test menu with 'Hard Vacuum' test method

2 Test menu with 'Sniffing' test method

8.2.1 Test method

This menu is used to select a test method.

Access: Settings Screen + Menu [Test]		Choice - Setting limit ¹⁾
Method	To be selected The test method is chosen depending on the part to be tested. For more information about leak detection test methods, see <i>Leak detector compendium</i> on the www.pfeiffer-vacuum.com website.	Hard Vacuum Sniffer

1) Initial setting: see chapter "Tree diagram of the Settings menu"



Tracer gas or test method setting modification

The selected test method and tracer gas have an impact on the calibration.

It is mandatory to perform a calibration of the detector if one of the following parameters is modified:

- test method (hard vacuum or sniffing)
- tracer gas (^4He , ^3He or H_2)



For quick access from the main screen, configure a function key to **[Method]** (see chapter “Function keys”).



By default, the leak detector is set to work in a hard vacuum test, in the most sensitive test mode: this setting meets the majority of the users’ needs.

8.2.2 Correction factor

The correction factor allows correction for the leak rate measured by the leak detector when:

- the detector is combined with parallel pumping,
- the concentration of tracer gas is lower than 100%.

Display

The **COR** indicator light is displayed on the control panel when the correction factor value is not 1.

The leak rate displayed takes into account the correction factor applied.



Use of the correction factor must not replace calibration.

Access: Settings Screen + Menu [Test]		Choice - Setting limit ¹⁾
HV correction	To be enabled	Enabled Disabled
	To be set If the correction factor is not known, from the [Correction] function key, click on [Auto Cor] : this function calculates the correction factor to be applied and applies it automatically.	$1 \cdot 10^{+20} - 1 \cdot 10^{-20}$

1) Initial setting: see chapter “Tree diagram of the Settings menu”



For quick access from the main screen, configure a function key to **[COR]** (see chapter “Function keys”).



Example

The table below shows the leak rate displayed according to the correction factor applied.

Example: leak rate displayed with a calibrated leak of $1 \cdot 10^{-7}$ mbar · l/s ($1 \cdot 10^{-8}$ Pa · m³/s) (with 100% ⁴He)

% ⁴ He in the gas used	100%	50%	5%	1%
Leak rate displayed on the leak detector without correction factor	$1 \cdot 10^{-7}$ mbar · l/s ($1 \cdot 10^{-8}$ Pa · m ³ /s)	$5 \cdot 10^{-8}$ mbar · l/s ($5 \cdot 10^{-9}$ Pa · m ³ /s)	$5 \cdot 10^{-9}$ mbar · l/s ($5 \cdot 10^{-10}$ Pa · m ³ /s)	$1 \cdot 10^{-9}$ mbar · l/s ($1 \cdot 10^{-10}$ Pa · m ³ /s)
Correction factor value	1	2	20	100
Leak rate displayed on the leak detector with correction	$1 \cdot 10^{-7}$ mbar · l/s ($1 \cdot 10^{-8}$ Pa · m ³ /s)			

8.2.3 Test mode

This menu is used to select a test mode.

The leak detector will automatically switch to the test mode selected when the internal pressure reaches the crossover threshold (see chapter “Leak Detection: Crossover pressures”).

Access: Settings Screen + Menu [Test]		Choice - Setting limit ¹⁾
Mode	To be selected	Gross Leak Normal High Sensitivity

1) Initial setting: see chapter “Tree diagram of the Settings menu”



For quick access from the main screen, configure a function key to **[Mode]** (see chapter “Function keys”).

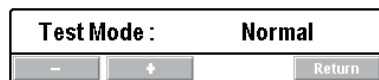

By default, the leak detector is set to work in a hard vacuum test, in the most sensitive test mode: this setting meets the majority of users' needs.

8.2.4 Probe type

This menu is used to select the sniffer probe type used in sniffing (see chapter “Accessories”).

Access: Settings Screen + Menu [Test]		Choice - Setting limit ¹⁾
Probe type	To be selected Standard sniffer probe: model with rigid nozzle only	Standard Smart

1) Initial setting: see chapter “Tree diagram to the Settings menu”



Set the probe clogged threshold to verify that the sniffer probe is operational (see chapter “Probe clogged threshold”).

8.2.5 Automatic cycle end

This function allows automatic control of the roughing time and measurement time in a hard vacuum test.

Access: Settings Screen + Menu [Test] [Cycle End]		Choice - Setting limit ¹⁾
Automatic cycle end	To be selected <ul style="list-style-type: none"> Operator: manual cycle end by the user Automatic: automatic cycle end based on configuration below. 	Operator Automatic
Roughing Timer (If automatic cycle)	To be enabled Roughing duration check	Enabled Disabled
	To be set (optional) Maximum authorized roughing duration. If the control is activated and time expires (detector still in roughing) = part rejected	0 – 1 h
Test Timer (If automatic cycle)	To be set (required) Duration of measurement. When time expires, the measured leak rate is displayed.	0 – 1 h

1) Initial setting: see chapter “Tree diagram of the Settings menu”



Function to be used to automate a small production.

8.2.6 Inlet vent

This function allows an inlet vent after a hard vacuum test stop.

This function allows the detector's inlet, and therefore the connected part or installation, to return to atmospheric pressure.

This function is secured: a confirmation message "Inlet vent? Please confirm." appears each time the user requests an inlet vent.

NOTICE	
Risk of pollution of the test chamber or of the process	
Never program an 'automatic' inlet vent when the detector is connected to a hard vacuum test or process chamber.	
<ul style="list-style-type: none"> ▶ Select 'Operator' and delete the function key allocated to the automatic inlet vent. The inlet vent must be carried out using the menu, which can be password locked. 	

Access: Settings Screen + Menu [Test] [Inlet Vent]		Choice - Setting limit ¹⁾
Inlet vent	To be selected <ul style="list-style-type: none"> • Operator: the inlet vent is carried out by the user by pressing on the [Inlet Vent] function key or on the corresponding pictograph on the main screen. • Automatic: the inlet vent is automatically carried out when the START/STAND-BY key is pressed to stop the test. 	Operator Automatic
Delay (For automatic inlet vent)	To be set (required) Delay = time between test stop and automatic opening of the inlet vent valve. This allows a managed valve to close automatically before inlet vent.	0 – 2 s
Vent Timer (For automatic inlet vent)	To be enabled (optional) Activation of the automatic closure of the inlet vent valve.	Enabled Disabled
	To be set Vent Timer = time between the opening of the air inlet valve and its automatic closing. This allows for limitation of the consumption of dry air or nitrogen if the purge is connected.	0 – 1 h

1) Initial setting: see chapter "Tree diagram of the Settings menu"



For quick access from the main screen, configure a function key to **[Inlet Vent]** (see chapter "Function keys").

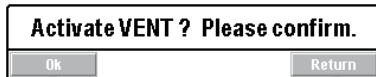

- The **[Inlet Vent]** function key is required for the operator to carry out a manual inlet vent (see chapter "Function keys").
- To lock the command for the inlet vent valve, delete the **[Inlet Vent]** function key. The icon remains on the main screen as an indicator but manual activation by the operator is disabled.



By connecting an inlet vent (or nitrogen) line to the inlet vent, the detector's tracer gas pollution is reduced.

8.2.7 Memo function

This function freezes the main screen at the end of a test: the last measured leak rate from the test is displayed and flashes.

Access: Settings Screen + Menu [Test] [Memo Function]		Choice - Setting limit ¹⁾
Active	To be enabled Activation of the Memo function	No Yes
Display Time	To be enabled <ul style="list-style-type: none"> Enabled = the value of the measured leak rate flashes for the set duration. Disabled = the value of the measured leak rate will flash until a new test begins. 	Enabled Disabled
	To be set Display time	0 – 1 h

1) Initial setting: see chapter “Tree diagram of the Settings menu”



For quick access from the main screen, configure a function key to **[Memo]** (see chapter “Function keys”).

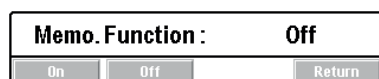

8.2.8 Zero activation

This function helps the user to identify very small leak rate variations in the surrounding background noise or to dilate small measured leak rate fluctuations on the analog display.

When the zero function is activated, a 2-decade bargraph appears on the main screen.

Access: Settings Screen + Menu [Test] [Zero Activation]		Choice - Setting limit ¹⁾
Activation	To be selected <ul style="list-style-type: none"> None: ZERO button inactive Operator: user activation by pressing on the [Zero] function key, depending on configuration (see below: Zero Exit) Automatic: depending based on configuration (see below: Trigger) 	None Operator Automatic
Zero Exit (If operator)	To be selected Type of press to exit the function (see below) <ul style="list-style-type: none"> Press once: activate/deactivate zero by quickly pressing the [Zero] function key. Press > 3 s: <ul style="list-style-type: none"> activation: quickly press the [Zero] function key. Each time the key is pressed quickly, a new zero is carried out. deactivation: press > 3 s on the [Zero] function key. 	Press once Press > 3 s
Trigger (If automatic)	To be selected Factor for initiating the carrying out of another zero.	Time Set point
	To be set Initiation value	0 – 1 h (if Time) $1 \cdot 10^{+19}$ – $1 \cdot 10^{-19}$ (if Set Point)

1) Initial setting: see chapter “Tree diagram of the Settings menu”



For quick access from the main screen, configure a function key to **[Zero]** (see chapter “Function keys”).



Using this function is recommended when the background of the tracer gas is stable. This function is used to measure a leak rate that is lower:

- than 2 decades in hard vacuum test mode: $1 \cdot 10^{-12}$ mbar · l/s ($1 \cdot 10^{-13}$ Pa · m³/s) minimum
 - than 2 decades in sniffing mode: $1 \cdot 10^{-7}$ mbar · l/s ($1 \cdot 10^{-8}$ Pa · m³/s) minimum
- than the detector’s background, when the detector is no longer in roughing.

8.2.9 Bypass option

For more information about the Bypass and installing it on the leak detector, see the operating instructions included with the Bypass.

Prerequisite(s)

- Detector equipped with a 37-pin I/O communication interface (option/accessory) (see chapter “Accessories”)
- From the Settings screen, press **[Advanced] [I/O Connector] [Quick View]** and check that the following I/Os are set (initial settings).

Required setting (see operating instructions for 37-pin I/O communication interface)

- Digital Input 32 – Ground = Bypass option
- Digital Transistor Output 9 – 28 = Bypass

- Bypass attached to the detector (see “Accessories” chapter)
- Bypass pump connected to the detector (at the customer’s charge)
- DN 25/DN 40 ISO-KF adapter (at the customer’s charge)

Access: Settings Screen + Menu [Test] [Bypass Option]		Choice - Setting limit ¹⁾
Mode	To be selected <ul style="list-style-type: none"> • No Bypass = External Bypass pump installed but not enable • Quick pumping = External Bypass pump active only during roughing • Partial flow = External Bypass pump active during roughing and test + leak rate correction to be applied 	No Bypass Quick pumping Partial Flow
Evac. delay	To be enabled (optional) <ul style="list-style-type: none"> • On = roughing only via the external Bypass pump • Off = roughing via the external Bypass pump and the detector’s primary pump. 	Off On

1) Initial setting: see chapter “Tree diagram of the Settings menu”

		1 st case	2 nd case	3 rd case	4 th case	5 th case
Pumping	Roughing	Primary pump detector only	External Bypass pump only	External Bypass pump only	External Bypass pump + Detector primary pump	External Bypass pump + Detector primary pump
	Cross over threshold to Gross Leak test (20 mbar (20 hPa) by default)					
	Test	Detector pumping only	Detector pumping only	External Bypass pump + Detector pumping ¹⁾	Detector pumping only	External Bypass pump + Detector pumping ¹⁾
Setting	Mode	No Bypass	Quick pumping	Partial Flow	Quick pumping	Partial Flow
	Evac. delay	On/Off	On	On	Off	Off

1) In this case, leak rate correction to be applied

8.2.10 Regeneration

This function is used to ‘clean’ the tracer gas from the detector by automatically carrying out a series of short tests and inlet vents between each test. This allows the background to be decreased following pollution with tracer gas.

NOTICE

Risk of pollution

- ▶ Before starting this function, make sure that the leak detector is in an environment free of tracer gas pollution.



For quick access from the main screen, configure a function key to **[Regeneration]** (see chapter “Function keys”).



It is recommended to use this function when there is a high level of background.

1. Check that the detector is in “Stand-by” mode.
2. Check that the inlet vent is “automatic.”
3. From the Settings screen, press **[Test] [Regeneration]**.
4. Install a blank-off flange on the detector’s inlet port.
5. Press **[Start]**.
 - Regeneration stops automatically after 1 hour.
6. To stop regeneration before the automatic stop time, press **[Stop]** or the **START/STAND-BY** key.
 - Start a test (“Zero activation” function not activated) to check that the detector is no longer polluted.

After regeneration, the inlet vent configuration is the same as it was before regeneration.

8.2.11 Massive mode

This mode allows the detector to perform a test (⁴He only) on a very large leak when the detector has not shifted to Gross Leak mode and remains in roughing.

Massive mode can only be used if an external gauge is selected (see chapter “Leak Detection: External gauge”).

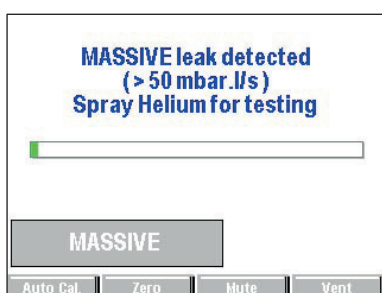

Access: Settings Screen + Menu [Test] [Massive Mode]		Choice - Setting limit ¹⁾
Active	<p>To be selected</p> <p>Prerequisites for the detector to shift automatically into Massive mode:</p> <ul style="list-style-type: none"> • function activated • pressure < 100 hPa • pressure stabilized for at least 30 s <p>A message informs the user that the detector has shifted automatically into Massive mode.</p> <p>The detector can then perform a qualitative test of a leak (information leak > 50 mbar · l/s (5 Pa · m³/s) only).</p> <p>The maximum use time is 55 minutes.</p>	No Yes
Sensitivity	<p>To be selected</p> <ul style="list-style-type: none"> • High = large volume test (default configuration, recommended) • Low = test on volume < 1 l (if necessary) 	High Low

1) Initial setting: see chapter “Tree diagram of the Settings menu”

8.3 Spectro menu

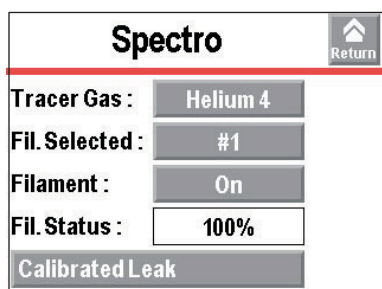

8.3.1 Tracer gas

This menu is used to select the tracer gas.

Access: Settings Screen + Menu [Spectro]		Choice - Setting limit ¹⁾
Tracer gas	To be selected The tracer gas is the gas searched for during a test.	Helium 4 Helium 3 Hydrogen

1) Initial setting: see chapter "Tree diagram of the Settings menu"



Tracer gas or test method setting modification

The selected test method and tracer gas have an impact on the calibration. It is mandatory to perform a calibration of the detector if one of the following parameters is modified:

- test method (hard vacuum or sniffing)
- tracer gas (⁴He, ³He or H₂)



For quick access from the main screen, configure a function key to **[TRACER GAS]** (see chapter "Function keys").



Hydrogen test

⚠ WARNING

Risk of injury due to the use of hydrogen as tracer gas

Hydrogen can be used as a tracer gas for leak detection. Depending on its concentration, in the worst scenario, there may be a risk of explosion.

- ▶ Never use a tracer gas with a hydrogen content greater than 5%.
- ▶ Use hydrogenated nitrogen as a tracer gas: mix of 95% N₂ and 5% H₂.

The detector's background is higher in H₂ than in ⁴He/³He.

Typical background in H₂, in test, when the detector is equipped with a blank-off flange on the inlet port:

- at start-up: low range ± 3 · 10⁻⁶ mbar · l/s (3 · 10⁻⁷ Pa · m³/s)
- after 2 or 3 hours : low range ± 5 · 10⁻⁷ mbar · l/s (5 · 10⁻⁸ Pa · m³/s)

8.3.2 Filament parameters

Access: Settings Screen + Menu [Spectro]		Choice - Setting limit ¹⁾
Filament selected	To be selected Filament in use for the measurement (2 filaments in the analyzer cell).	1 2
Filament	To be selected Status of the filament in use when the detector is on. <ul style="list-style-type: none"> • Off: filament off • On: filament on 	Off On
Filament status	Read only Performance indicator of the analyzer cell for the selected filament. <ul style="list-style-type: none"> • Default settings: between 90% and 100% • Normal operation: between 10% and 100% The value of this indicator is updated after a leak detector calibration. Normal wear on some cell components will reduce this value over time but will not reduce the accuracy of the detector's measurements.	-

1) Initial setting: see chapter "Tree diagram of the Settings menu"

8.3.3 Calibrated leak

Information concerning calibrated leaks (see chapter "Calibration")

Access: Settings Screen + Menu [Spectro] [Calibrated leak]		Choice - Setting limit ¹⁾
Tracer gas	To be selected The tracer gas is the gas searched for during a test. This is the gas contained in the calibrated leak used for calibration.	Helium 4 Helium 3 Hydrogen
Type	To be selected Type of calibrated leak used for calibration <ul style="list-style-type: none"> Internal: calibration based on leak detector's internal calibrated leak (⁴He leak only). External: calibration based on external leak detector (⁴He, ³He, or ²H). Concentration: calibration from ambient air 	Internal External Concentration ³⁾
Unit	To be selected Unit of calibrated leak used for calibration ²⁾	mbar · l/s Pa · m ³ /s Torr · l/s atm · cc/s ppm ³⁾
Leak value	To be set Value of calibrated leak used for calibration ²⁾	$1 \cdot 10^{+12} - 1 \cdot 10^{-12}$
Calibration valve	To be selected Current state of calibration valve Used to open/close the manual calibration valve, for example. Remember to close the valve again after use. Manual calibration is reserved for experts only.	Open Closed
Loss per Year (%)	To be set Set the loss per year for the calibrated leak used for calibration ²⁾	0 – 99
Ref. T. (°C)	To be set Reference temperature for the calibrated leak used for calibration ²⁾	0 – 99
Coeff. T. (%/°C)	To be set Temperature coefficient for the calibrated leak temperature used for calibration ²⁾	0.0 – 9.9
Year	To be set Month and year of calibration for the calibrated leak used for calibration ²⁾	-
T. Internal (°C) (if Type = internal)	Read only Temperature of the detector's internal calibrated leak	-
T. External (°C) (if Type = external)	To be set Configuration of external temperature	0 – 99

1) Initial setting: see chapter "Tree diagram of the Settings menu"

2) Use the information indicated on the calibrated leak used for calibration or on its calibration certificate.

3) If 'Sniffer' test method selected

In case of leak replacement, these parameters must be updated.

When the parameters are saved, all the data from all the set calibrated leaks (1 internal leak (⁴He) and 3 external leaks (⁴He, ³He and H₂)) is stored.

8.4 Maintenance menu

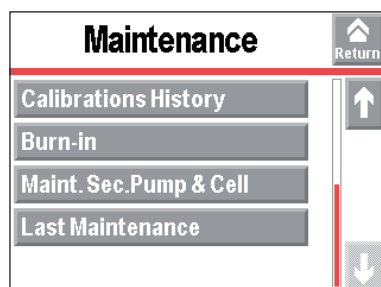
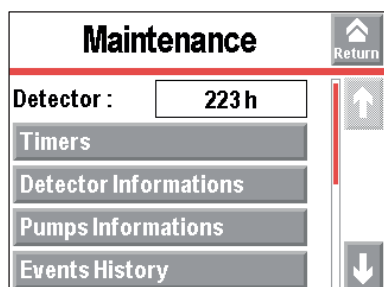

8.4.1 Detector

Access: Settings Screen + Menu [Maintenance]

Detector	Read only Detector running time
----------	------------------------------------

8.4.2 Timers



For quick access from the main screen, configure a function key to **[Maintenance]** (see chapter “Function keys”).

Access: Settings Screen + Menu [Maintenance] [Timers]		Choice - Setting limit ¹⁾
Detector	Read only Detector running time	-
Filament 1	Read only Running time for filament 1	-
	Function to be launched 1. Press [xxx h] to access the reset function. 2. Press [Reset timer] to reset the timer.	-
Filament 2	Read only Running time for filament 2	-
	Function to be launched 1. Press [xxx h] to access the reset function. 2. Press [Reset timer] to reset the timer.	-
Calibrated Leak.	Read only Indicates the month and year of calibration for the calibrated leak used for calibration.	-
Cycles	Read only [xxxx Cy/xxxx Cy]: number of cycles carried out since the last reset compared to the configured cycle interval. When the configured cycle interval is reached, an information message is displayed. Press [xxxx Cy/xxxx Cy] to access additional information (see below ‘Additional information about Cycles’).	-
Prim. Pump	Read only [xxxx h/xxxx h]: running time of the primary pump since the last reset compared to the configured running time interval. When the configured running time interval is reached, an information message is displayed. Press [xxxx h/xxxx h] to access additional information (see below ‘Additional information about Main Pump / Secondary Pump 1 / Secondary Pump #’).	-

1) Initial setting: see chapter “Tree diagram of the Settings menu”

Access: Settings Screen + Menu [Maintenance] [Timers]		Choice - Setting limit ¹⁾
Sec. Pump #1	Read only [xxxx h/xxxx h]: running time of the secondary pump 1 since the last reset compared to the configured running time interval. When the configured running time interval is reached, an information message is displayed. Press [xxxx h/xxxx h] to access additional information (see below 'Additional information about Main Pump / Secondary Pump 1 / Secondary Pump #').	-
Sec. Pump #2 (ASM 392 only)	Read only [xxxx h/xxxx h]: running time of the secondary pump 2 since the last reset compared to the configured running time interval. When the configured running time interval is reached, an information message is displayed. Press [xxxx h/xxxx h] to access additional information (see below 'Additional information about Main Pump / Secondary Pump 1 / Secondary Pump #').	-

1) Initial setting: see chapter "Tree diagram of the Settings menu"

Additional information about Cycles

Access: [xxxx Cy/xxxx Cy] for the 'Cycle' parameter		Choice - Setting limit ¹⁾
Cycles	Read only Percentage of the number of cycles carried out since the last reset compared to the configured cycle interval.	-
Counter	Read only Number of cycles carried out since the last counter reset.	-
Time interval	To be set Number of reference cycles When the number of reference cycles is reached, an information message is displayed.	$1 \cdot 10^{+19} - 1$
Reset counter	Function to be launched Press [Reset counter] to reset the timer.	-

1) Initial setting: see chapter "Tree diagram of the Settings menu"

Additional information about Primary Pump / Secondary Pump 1 / Secondary Pump 2

Access: [xxxx h/xxxx h] for the parameter 'Prim. Pump' / 'Sec. Pump #1' / 'Sec. Pump #2'		Choice - Setting limit ¹⁾
Pump xxxx	Read only Percentage of the running time of the xxxx pump since the last reset compared to the configured running time interval.	-
Timer	Read only Running time since the last timer reset	-
Time interval	To be set Reference running time When the configured running time interval is reached, a message is displayed.	0 – 99999
Reset timer	Function to be launched Press [Reset timer] to reset the timer.	-

1) Initial setting: see chapter "Tree diagram of the Settings menu"

8.4.3 Detector information



For quick access from the main screen, configure a function key to **[Info]** (see chapter “Function keys”).

Detector Informations		Return
Apr/09/2013 15:48		
v.LCD :	4.0.00b (L0232)	
v.CPU :	3.3.97 (L0308)	
v.CELL :	3.3.02 (L0264)	
P Inlet :	3.4E-01 mbar	
Reject Pt :	1.0E-08 mbar.lfs	
Calibration :	Auto [Int.]	
Gas :	Helium	
Filament :	#1 [On]	
Status :	100%	
Last Calib. :	14:41:58	
Next Maintenance :	15780 h	

Reminder: for viewing only in this menu

Access: Settings Screen + Menu [Maintenance] [Detector Information]

Software version .LCD	Control panel firmware information
Software version .CPU	Leak detector firmware information
Software version .CELL	Analyzer cell firmware information
P. Inlet	Inlet pressure
Reject Point	Reject point set for the test method in progress
Calibration	Type of calibration configured
Gas	Tracer gas selected
Filament	Filament used (Status of filament used, detector on)
Status	Filament use rate (100% = new filament)
Last Calib.	Date of last calibration
-	List of activated functions (blank line if none)
Next maintenance	Time before the next maintenance to be performed

8.4.4 Pump information

Primary pump information

Reminder: for viewing only in this menu

Access: Settings Screen + Menu [Maintenance] [Pump Information] [Prim. pump #1]

Used	Control of the pump by the detector
Status	Pump status
Speed	Pump use speed setting: Max/Min/Nominal

► For more information about the primary pump, press **[ACP Information]**.

ACPInformations		Return
-ACP pump-		
Synchro :	Ok	
Power :	435 W	Type : ACP40
Address :	#000	Software : VB.07
-Temperature-		
T° Electronic :	41 °C	
-Last maintenance-		
	2556 h / 18000 h	
-Warning-		

Secondary Pump #1 and #2

Reminder: for viewing only in this menu

Secondary Pump #2: ASM 392 only

Access: Settings Screen + Menu [Maintenance] [Pump Information] [Sec. Pump #1] or [Sec. Pump #2]

Used	Control of the pump by the detector
Rotation	Pump status: Synchro/Down/Fail/Running/Ram up
Speed (rpm)	Pump rotation speed (max 900000 rpm)
Synchro	Pump at set use speed.

► For more information about the secondary pump, press **[TMP Information]**.

TMP Informations		Return
Turbo molecular pump		
Rot. Speed :	1500 Hz / 90000 rpm	
Voltage :	23.63 V	Synchro : Ok
Power :	17 W	TC type : TC 110
Current :	0.75 A	TC Software : 012099
Temperature		
T° Electronic :	48 °C	T° Bottom : 40 °C
T° Bearing :	40 °C	T° Motor : 44 °C
Last maintenance		
1009 h / 16000 h		
Warning		
None		

8.4.5 Event history

The event history records the last 30 events. Beyond 30, the oldest recorded event will be replaced by the most recent, and so on.

Access: Settings Screen + Menu [Maintenance] [Events History]

Events History		Return
Events:1		
1313	09/04/13 00:08	Date/Time updat
1320	01/01/13 00:02	Int. Pirani Calib

1 → Export
2 → [Event Code]
3 → [Date/Time]
4 → [Description]

- | | |
|---|------------------------------|
| 1 Exporting the history in .csv format to the SD card | 3 Date and time of the event |
| 2 Event code | 4 Description of the event |

An event can be an error (Exxx), a warning (Wxxx) or an information (Ixxx).

- List of errors and warnings: refer to the RS-232 link operating instructions (see chapter “Applicable documents”).
- Information list

Code	Event	Description
I300	Air inlet	Air inlet
I301	Stp on pollution	Test stops automatically if measured leak rate pollution > Pollution
I302	Rst count RVP	Primary pump counter reset
I303	Rst count TMP1	Secondary pump 1 hour counter reset
I304	Rst count TMP2	Secondary pump 2 hour counter reset (depending on detector model)
I306	Rst count Fil1	Filament 1 hour counter reset
I307	Rst count Fil2	Filament 2 hour counter reset
I308	Rst count cycle	Cycle counter reset
I310	Autocal restart	Automatic start of a new calibration
I313	Date/Time update	Date or time modification
I318	Full param reset	Complete detector parameter reset
I319	Fil change	Filament change (manually or automatically) from Maintenance menu
I320	Int. Pirani Calib.	Automatic internal Pirani gauge calibration
I321	Storage delay	Detector switched off for 15 days (minimum)

8.4.6 Calibration history

The calibration history records the last 20 calibrations made. Beyond 20, the oldest recorded calibration will be replaced by the most recent and so on.

Access: Settings Screen + Menu [Maintenance] [Calibration History]

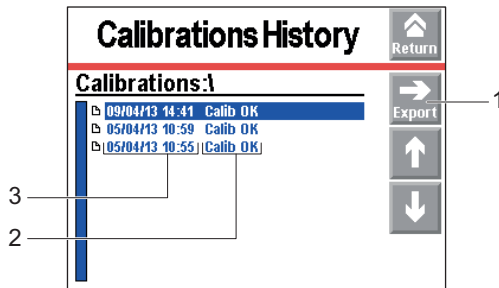

- 1 Exporting the history in .csv format to the SD card 3 Date and time of the calibration
2 Calibration result

8.4.7 Burn-in

This function is used to prepare the detector, leaving it in optimal working condition by automatically carrying out a series of short tests and inlet vents between each test.

Prerequisite(s)

- Detector on “Standby” mode
- “Automatic” inlet vent

Access: Settings Screen + Menu [Maintenance] [Burn-in]

NOTICE

Risk of pollution

- ▶ Before starting this function, make sure that the leak detector is in an environment free of tracer gas pollution.

1. Install a blank-off flange on the detector’s inlet port.
2. Press **[Start without calib]** or **[Start with calib]**.
 - **[Start without calib]**: series of tests and inlet vents
 - **[Start with calib]**: series of tests, inlet vents, and calibrations (not available in sniffing test)
3. To stop burn-in, press **[Stop]** or the **START/STAND-BY** key.

8.4.8 Secondary pump and analyzer cell maintenance

This function is used to shut down the secondary pump and to perform an inlet vent so that the secondary pump and the analyzer cell are at atmospheric pressure.

To carry out maintenance on the secondary pump or the analyzer cell, the vacuum part of the detector must be at atmospheric pressure.

ASM 392: this procedure applies to the maintenance of each secondary pump.

Access: Settings Screen + Menu [Maintenance] [Maint. Sec. Pump & Cell]

1. Press **[Stop & Vent]**.
 - The secondary pump slows to a speed that allows venting.
 - A message notifies the user when the leak detector can be shut down.
 - If the user does not wish to stop the detector, press **[Restart detector]**. The detector start-up screen is displayed.
 2. Power off the detector.
 3. Wait until the control panel turns off completely and unplug the main power supply cable before working on the detector.
- ▶ Optional:
Press **[Stop & Vent]** to carry out additional venting before powering off the detector.

8.4.9 Last maintenance

This function is used to display the 3 last maintenance operations performed on the detector and recorded by the service technician.

- Use the lift to see the 3 last recorded maintenance operations.

Access: Settings Screen + Menu [Maintenance] [Last maintenance]

Date	Date of the maintenance work
Nbr hours	Number of hours of detector operation at the time of maintenance
Inspected by	Maintenance technician who performed the work

8.5 Configuration menu

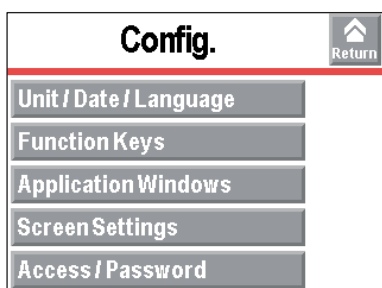

8.5.1 Time – Date – Unit – Language

Access: Settings Screen + Menu [Configuration] [Unit/Date/Language]		Choice - Setting limit ¹⁾
Unit	To be selected ¹⁾ The set points/values set are not automatically converted to the new unit if the unit changes: they must be updated by the user.	mbar · l/s Pa · m ³ /s Torr · l/s atm · cc/s ppm sccm sccs mtorr · l/s
Date	To be set ¹⁾	- Format: Month Day Year (mm/dd/yyyy)
Time	To be set ¹⁾ The time is not automatically updated when switching from summer time to winter time and vice versa: it must be updated by the user.	- Format: Hour Minute Second (hh:mm:ss)
Language	To be set ¹⁾	English French German Italian Chinese Japanese Korean Spanish Russian

1) No default settings: set by user on switching the detector on for the 1st time

8.5.2 Function keys

Function keys are used to start/stop a function or to adjust set points.

Using the function keys, a user can be given access to a limited number of functions.

The function keys can be managed using 4 access buttons.

By default, the 8 function keys are allocated and distributed over 2 levels: they can be reallocated by the user.

Up to 4 additional function keys can be added, for a maximum of 12. In this case, a 3rd level will be presented to the user.

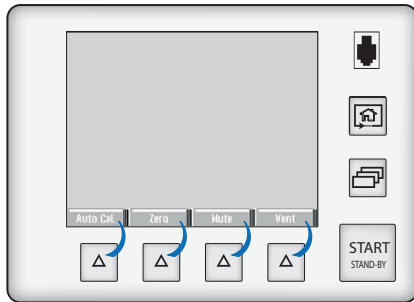

Using the function keys, the user can be given access to a limited number of functions and to use a password to lock unauthorized functions on the “Settings” menu. These are sufficient to manage the detector.

To allow the user to use only the **START/STAND-BY** key, do not allocate a function to the function keys and lock the “Settings” menu.

Allocating function keys

Each function key can be allocated to a function chosen by the user: see the example below.

Access: Settings Screen + Menu [Configuration] [Function keys]

Example: Allocate the ‘Correction’ function to the function key currently attributed to [Mode].

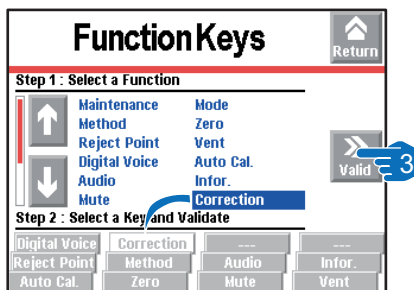
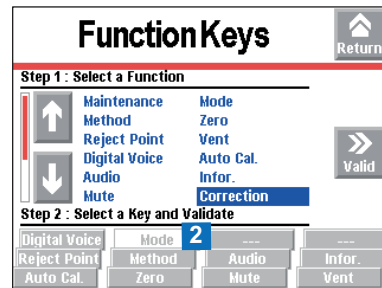
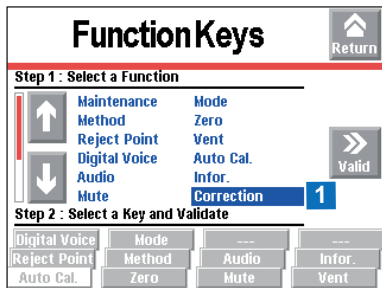

1. Select the ‘Correction’ function using the arrows.
2. Select the **[Mode]** function key by pressing repeatedly (function key selected if background is white).
3. Validate the selections.
 - The function key previously allocated to **[Mode]** is now assigned to the **[Correction]** function.

8.5.3 Application windows

The user can display/hide one or more screens or change the order in which they scroll in the loop.

By pressing repeatedly on the key , the various application windows displayed in the loop appear (see chapter “Touch screen”).

Main screen (Standard) is always displayed in the 1st position.

Access: Settings Screen + Menu [Configuration] [Application windows]

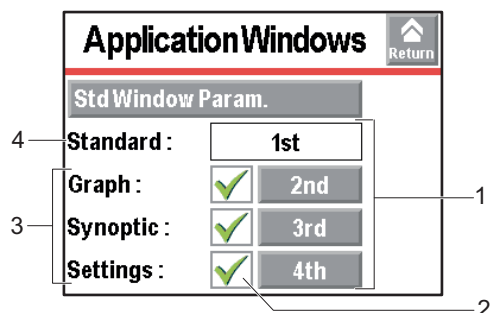

- 1 Order of screens displayed with the  key
2 Display (✓)/Hide (✗) for application windows

- 3 Available screens
4 Main screen (standard) always displayed

Access: Access: Settings Screen + Menu [Configuration] [Application windows]		Choice - Setting limit ¹⁾
Standard	Read only Main screen display	Activated by default
	Read only Order in the loop	1 st
Graph	To be selected Graph screen display	Activate Deactivate
	To be set Order in the loop	2 nd – 4 th
Synoptic	To be selected Synoptic display	Activate Deactivate
	To be set Order in the loop	2 nd – 4 th
Settings	To be selected Settings screen display	Activate Deactivate
	To be set Order in the loop	2 nd – 4 th

1) Initial setting: see chapter “Tree diagram of the Settings menu”

Display/Hide for a screen

A screen in the loop can be displayed/hidden.

The main application screen (Standard) is always displayed in the 1st position.

- When a screen is no longer displayed (✗), the overall order is automatically updated (see example 2).
 - When a screen is once again displayed (✓), it is automatically placed in the last position (see example 3).
- ▶ Press the [✗] key on the screen to be displayed.
▶ Press the [✓] key on the screen to be hidden.

Modification of the display order

The order of a screen in the loop can be modified.

The main application screen (Standard) is always displayed in the 1st position.

- When the display order for a screen is modified, the overall order is automatically updated (see example 1).
1. Press the order number on the screen for the screen to be modified.
 2. Press the [+] and [-] to choose the new order number.
 3. Press [Valid].

Example 1

- The Synoptic screen moved from position 3 to 4 in the loop.

Example 2

- The Graph screen is hidden and the overall order is updated.

Example 3

- The Graph screen is once again available in position 4 in the loop.

Setting of the main screen (Standard)

This menu is used to enter the control panel settings.

Access: Settings Screen + Menu [Configuration] [Application windows] [Standard Window Parameters]			Choice - Setting limit ¹⁾
Bargraph leak rate	Zoom on Set Point	To be selected Zoom on set point is used to display on the bargraph the reject set point centered on 2 decades.	No Yes
	Low Decade	To be set Low decade of the bargraph.	$1 \cdot 10^{+5} - 1 \cdot 10^{-13}$
	High Decade	To be set High decade of the bargraph.	$1 \cdot 10^{+6} - 1 \cdot 10^{-12}$
Stand-By value	To be selected Leak rate display in "Stand-by" mode	Hide Show	
Inlet Pressure	To be selected Inlet pressure display.	Hide Show	
Extra Pressure	To be selected Cell pressure display.	Hide Show	

1) Initial setting: see chapter "Tree diagram of the Settings menu"

Access: Settings Screen + Menu [Configuration] [Application windows] [Standard Window Parameters]		Choice - Setting limit ¹⁾
Disp. Value Min.	To be set This limit defines the lower display limit for the measured leak rate. The measured leak rate is not displayed if it is lower than the set lower display limit.	-
	Hard vacuum	$1 \cdot 10^{+19} - 1 \cdot 10^{-19}$
	Sniffing The value of the 'Probe Clogged' threshold must always be greater than the value of the "Display Value Min." threshold.	$1 \cdot 10^{+19} - 1 \cdot 10^{-19}$
Display 2 nd digit	To be selected Display of a second digit after the decimal point for digital display of the leak rate.	Hide Show

1) Initial setting: see chapter "Tree diagram of the Settings menu"

8.5.4 Screen settings

Access: Access: Settings Screen + Menu [Configuration] [Screen settings]		Choice - Setting limit ¹⁾
Brightness	To be selected	High Low
Contrast	To be set	0 – 100
Panel Off	To be selected The screen is in sleep mode when the back light goes off (black screen). The device appears to be off, but this is not the case! Simply touching the screen reactivates the display.	None 15 min 30 min 1 h 2 h 4 h
Func. Paging	Function available only if a wireless remote control is detected. To be selected When a wireless remote control (accessory) is used, the 'Paging' function makes it possible to easily find the remote if it is located within its field of use with the detector. When the function is activated, the remote control emits a sound signal so it can be located. To stop the sound signal, deselect the Paging function.	No Yes
Reset panel parameters	To be launched Resets control panel parameters	-

1) Initial setting: see chapter "Tree diagram of the Settings menu"

8.5.5 Access – Password

This menu is used to manage the access rights to the various menus and/or screens.

Regardless of the user level, a password is required to access this menu.

The default password is 5555.



The password is not saved in the control panel. If the password is lost, it can be retrieved by using the RS-232 serial link: see the RS-232 serial link operating instructions (see chapter "Applicable documents").

Access: Settings Screen + Menu [Configuration] [Access/Password] + password		Choice - Setting limit ¹⁾
Password	To be set	0 – 9999
Set Points menu access	To be selected	Lock ²⁾
Test menu access	Access to some menus may be authorized or forbidden.	Unlock ³⁾
Spectro menu access	See details below	
Maintenance menu access		
Configuration menu access		
Advanced menu access		
User Level	To be selected 3 user levels can be used to restrict the display and access to settings and functions. See details below	Restricted Access Medium Access Full Access
Change password	Function Access See details below	-

1) Initial setting: see chapter "Tree diagram of the Settings menu"

2) Pictograph padlock closed 

3) Pictograph padlock open 

Menu access

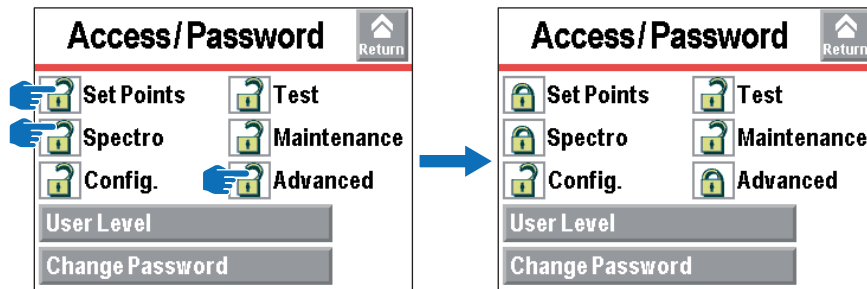

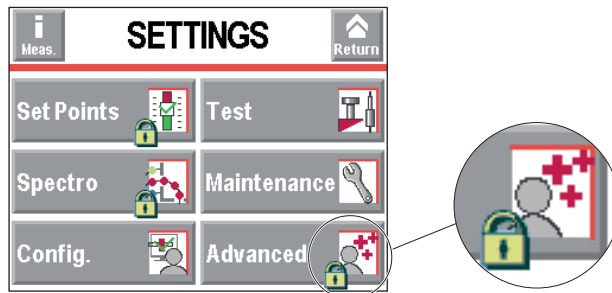

Example 1: locking of Set Points, Spectro and Advanced menus



Example 2: display of locked menus (Set Points, Spectro and Advanced) on the Settings screen

The user can prevent access for one or more menus on the Settings screen by locking them.

To access a locked menu, the user is asked to provide the password.



- ▶ Press the pictograph  to lock the relevant menu (see example 1).
 - On the Settings screen, the locked menus are indicated by a pictograph  (see example 2).
- ▶ Press the pictograph  to unlock the relevant menu.

User level

3 user levels can be used to restrict the display on the control panel and the users' access to settings/ functions:

- restricted access,
- medium access,
- full access.

The rights defined below are those granted **by default** for each user level.

	User level		
	Restricted access	Medium access	Full access
Key 	Disabled No settings can be made without a password	Disabled No settings can be made without a password	Enabled
START/STAND-BY key	Disabled Starting a test via communications interface only	Enabled	Enabled
Pictograph 	Disabled	Disabled	Enabled
Function keys	Masked	2 function keys available: <ul style="list-style-type: none"> • [Basic Param.] • [Info] 	Displayed
Display for inlet pressure and cell pressure	Masked	Masked	Displayed
Display of measured leak rate and reject setpoint displayed only in test	Display only in test	Display only in test	Yes
Access to settings menus	No No setting possible without a password (temporary access allowed)	No No setting possible without a password (temporary access allowed) Temporary access: <ol style="list-style-type: none"> 1. Press and hold the  button until the Settings screen is displayed with all of the locked menus. 2. Press on the menu to be opened. 3. Enter the current password. 4. Validate. 5. Configure the desired settings. 	Yes

Restricted access display

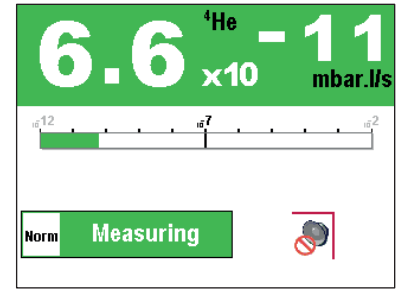
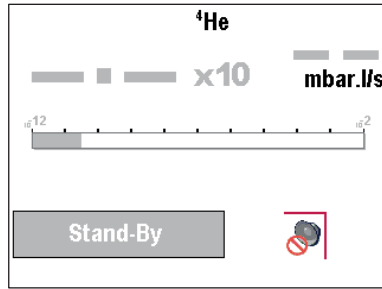

Medium access display

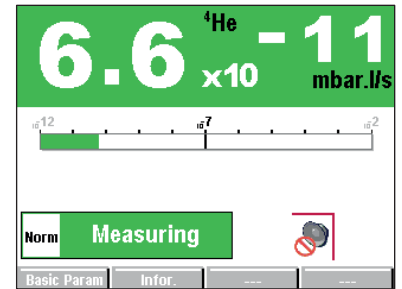
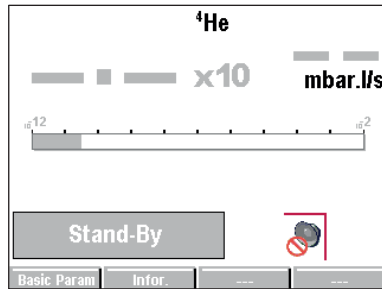

2 function keys available

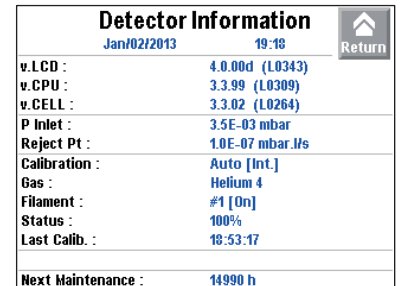
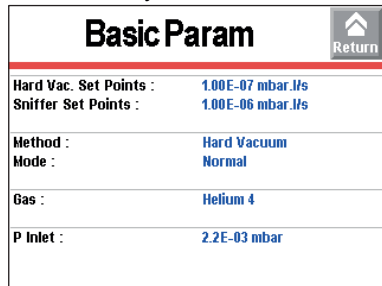

Full access display

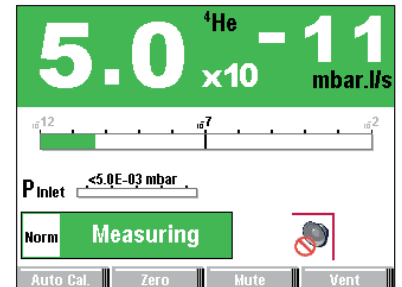
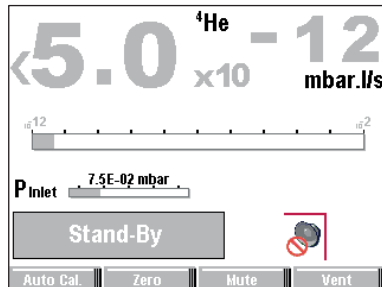

Access level change

For a user with restricted or medium access.	For a user with full access
<ol style="list-style-type: none"> 1. Press and hold the button until the Settings screen is displayed with all of the locked menus. 2. Press the Settings Screen + Menu [Configuration]. 3. Enter the current password. 4. Validate. 5. Press [Access/Password]. 6. Enter the current password. 7. Validate. 8. Press [User Level]. 9. Change the access level. 10. Validate. 	<ol style="list-style-type: none"> 1. Access: Settings Screen + Menu [Configuration] [Access/Password] 2. Enter the current password and validate. 3. Press [User Level]. 4. Change the access level. 5. Validate.

Change the password

Access: Settings Screen + Menu [Configuration] [Access/Password]

1. Enter password.
2. Validate.
3. Press **[Change Password]**.
4. Enter the new password.
5. Validate.

8.6 Advanced menu

The 'Advanced' menu is reserved for leak detection experts or for a particular product configuration.

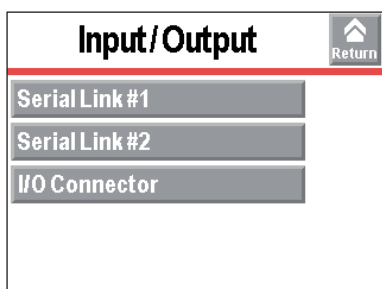
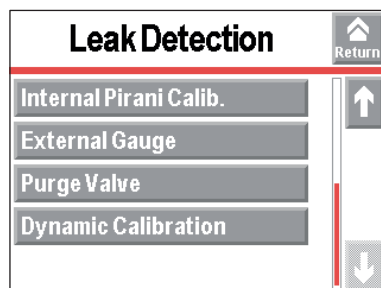
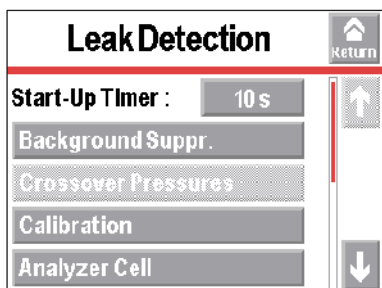
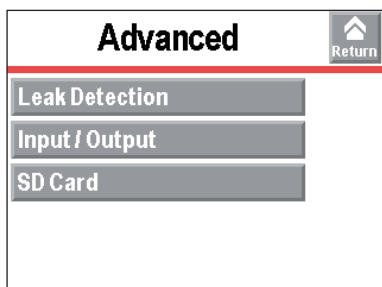

8.6.1 Leak Detection: Start Up timer

The start-up timer prevents the leak detector from being used for a pre-determined duration after it has been switched on. This means measurements cannot be made until the leak detector is thermally stabilized, or while traces of tracer gas remain in the detector.

Access: Settings Screen + Menu [Advanced] [Leak Detection] [Start Up Timer]		Choice - Setting limit ¹⁾
Start Up Timer	To be set	0 – 1h

1) Initial setting: see chapter "Tree diagram of the Settings menu"

8.6.2 Leak Detection: Background suppression

This function is used to suppress the detector's intrinsic background.



Keeping the background suppression enabled (On) is recommended.

Access: Settings Screen + Menu [Advanced] [Leak detection] [Background Suppression]		Choice - Setting limit ¹⁾
Background Suppression	To be enabled After calibration, if the function is enabled (On), the detector's background is below $1 \cdot 10^{-12}$ mbar · l/s ($1 \cdot 10^{-13}$ Pa · m ³ /s).	Off On

1) Initial setting: see chapter "Tree diagram of the Settings menu"

8.6.3 Leak Detection: Crossover pressures

In hard vacuum test, the user can consult the crossover threshold set in different test modes.

Access: Settings Screen + Menu [Advanced] [Leak detection] [Crossover pressures]			Choice - Setting limit ¹⁾
Crossover Pressures	Gross Leak	Read only Crossover threshold for Roughing in Gross Leak mode.	$2 \cdot 10^{+1} - 5 \cdot 10^{-1}$
	Normal	Read only Crossover threshold for Gross Leak mode in Normal mode.	$5 \cdot 10^{-1} - 2 \cdot 10^{-1}$
	High Sensitivity	Read only Crossover threshold from Normal to High Sensitivity mode.	$5 \cdot 10^{-2} - 3 \cdot 10^{-2}$

1) Initial setting: see chapter "Tree diagram of the Settings menu"

8.6.4 Leak Detection: Calibration

Calibration helps check that the leak detector is correctly adjusted to detect the tracer gas selected and display the correct leak rate (see chapter "Calibration").

By default, internal leak is selected to allow for a rapid calibration of the leak detector. It is also possible to calibrate the leak detector with an external leak (see chapter "Calibration").



Detector calibration

20 minutes after switching it on, the detector suggests that the user perform a calibration. For correct use of the detector and to optimize the accuracy of the measurement, **this calibration must be performed.**

It is recommended to perform a calibration:

- at least once a day,
- for intense operation: start calibration at the beginning of each work session (e.g. work in shifts, every 8 hours),
- if it is uncertain whether the detector is working properly.

Access: Settings Screen + Menu [Advanced] [Leak detection] [Calibration]			Choice - Setting limit ¹⁾	
Calibration	To be selected <ul style="list-style-type: none"> Operator Calibration initiated by the user pressing the [AUTOCAL] function key. If the calibration is not begun within 20 minutes of switching the detector on, the message "Detector ready for calibration" appears to prompt the user to start a calibration. <div style="border: 1px solid black; padding: 5px; width: fit-content; margin: 10px auto;"> <p style="text-align: center;">Detector ready for calibration.</p> <p style="text-align: center;">Auto Cal. Return</p> </div> <ul style="list-style-type: none"> Start-up A calibration check begins automatically when the detector is switched on: see details below. Manual Calibration starts manually. <p>Operation reserved for experts only</p>		Operator Start-up Manual	
Calibration checking	Checking	To be selected <ul style="list-style-type: none"> Operator: calibration checking not activated Automatic: calibration checking activated 	Operator Automatic	
	Frequency	Cycles	To be set Threshold (cycles) initiating calibration checking. Calibration checking begins when either the 'Cycles' or the 'Hours' threshold is reached.	0 – 9999
		Hours	To be set Set point (cycles) initiating calibration checking. Calibration checking begins when either the 'Cycles' or the 'Hours' threshold is reached.	0 – 9999

1) Initial setting: see chapter "Tree diagram of the Settings menu"

'Calibration checking' details



For quick access from the main screen, configure a function key to **[Calib. check]** (see chapter "Function keys").



At any time, the user can start a calibration check: with the leak detector in "Stand-by" mode, press the **[AUTOCAL]** function key twice within 5 seconds.

Calibration checking allows the user to save time because this operation is faster than full calibration.

The calibration control is performed with the leak detector's internal calibrated leak (leak type parameter = 'internal').

Calibration checking is disabled if calibration is set to 'manual.'

The leak detector compares the measured leak rate of the internal calibrated leak with the set leak rate of the internal calibrated leak:

- If the ratio is within the limits allowed, the leak detector is properly calibrated.
- If the ratio is out of limits, a message appears suggesting that a full calibration of the leak detector be started.

8.6.5 Leak Detection: Analyzer cell

This function is used to view information on the leak detector.

Access: Settings Screen + Menu [Advanced] [Leak detection] [Analyzer cell]		Choice - Setting limit ¹⁾
Filament Selected	To be selected Filament used for the measurement (2 filaments in the analyzer cell).	1 2
Filament	To be selected Activation (ON) or deactivation (OFF) of the filament in use for the measurement.	Off On
Triode pressure Electric Zero Target value Acceleration Voltage (V) Emission (mA) Coeff. Sens.	Read only Parameters for manual calibration. This type of calibration is reserved for leak detection experts.	-
Calibration Valve	To be selected Current state of calibration valve. Used to open/close manually the calibration valve. Do not forget to close the valve again. Manual calibration is reserved for experts only.	Off On
Internal Temperature (°C)	Read only Temperature of the detector's internal calibrated leak.	-

1) Initial setting: see chapter "Tree diagram of the Settings menu"



- When switched on, the leak detector uses the filament that was selected when the detector was shut down.
- The leak detector switches automatically from one filament to the other if the selected filament currently in use becomes defective.
- It is not necessary to turn off the filament in Stand-by mode to save it.
- Do not switch off the filament except for carrying out manual calibration. **Manual calibration is reserved for experts only.**

8.6.6 Leak Detection: Internal Pirani gauge calibration

This function is used to calibrate the detector's internal gauge.

Prerequisite(s)

- Test method: hard vacuum
- Most sensitive test mode selected
- End of cycle: operator (manual end of cycle by the user)

Procedure

The calibration takes place in 2 stages: setting the limit pressure and setting the atmospheric pressure.

Access: Settings Screen + Menu [Advanced] [Leak Detection] [Internal Pirani Calibration]

1. Close the detector's inlet with a blank-off flange.
2. Set the ultimate pressure.
 - Start a test: press the **START/STAND-BY** button.
 - The 'Pressure' value decreases: wait for this value to stabilize (about 5 minutes).
 - Make sure that the internal pressure is significantly lower than $1 \cdot 10^{-3}$ hPa.
 - Press the **[>HV]** key.
3. Set the atmospheric pressure.
 - Start a test: press the **START/STAND-BY** button.
 - Create an inlet vent: press **[Inlet vent]**.
 - Ensure that the detector is at atmospheric pressure.
 - The 'Pressure' value increases: wait for this value to stabilize (about 5 minutes).
 - Press the **[>Atm]** key.

8.6.7 Leak Detection: External gauge

This function allows the leak detector to be managed by an external gauge.

Prerequisite(s)

- Detector equipped with a 37-pin I/O communications interface (see chapter “Accessories”)
- Massive Mode deactivated
- Inlet pressure source: external
- Possible gauges

		Type of gauge detected by the detector	Gauge model
Linear gauge	Capacitive	Linear	CMRxxx
	Piezo	Linear	APRxxx
Logarithmic gauge	Pirani	TPR/PCR	TPRxxx
	Capacitive Pirani	TPR/PCR	PCRxxx

3 cables (3/10/20 m) available as accessories (see chapter “Accessories”)

The gauge and the connection cable are the customer’s responsibility.

Access: Settings Screen + Menu [Advanced] [Leak Detection] [External Gauge]		Choice - Setting limit ¹⁾
Gauge	To be selected External gauge model	None TPR PCR Linear
External Pressure (mbar)	Read only Pressure measured by the external gauge	-
Pressure Inlet Source	To be selected Inlet pressure displayed on the main screen: <ul style="list-style-type: none"> • Internal: internal leak detector gauge • External: external gauge on the customer’s installation 	Internal External
Full scale (mbar) (if “Linear”)	To be set Set the operating range for the gauge: value indicated on the gauge	0.1 – 5000

1) Initial setting: see chapter “Tree diagram of the Settings menu”

8.6.8 Input/Output: Serial link 1 and Serial link 2

The parameters displayed depend on the choices made.

Access: Settings Screen + Menu [Advanced] [Input/Output] then [Serial link 1] or [Serial link 2]		Choice - Setting limit ¹⁾
Type	To be selected Link type depending on use: see the operating instructions of the accessory/option to be used.	Serial ²⁾ USB ⁴⁾ Network ^{3) 4)} Not used ³⁾
Parameters	Mode	To be selected Link mode depending on use: see the operating instructions for the accessory/option to be used (see chapter "Applicable Documents"). Exhaustive list: availability depending on link used and communication interface installed Basic Spreadsheet Advanced Export Data RC 500 WL RC 500 HLT 5xx HLT 2xx Ext. module ²⁾
	Handshake	To be selected None XON XOFF
	Power Pin 9	Read only 5 V

1) Initial setting: see chapter "Tree diagram of the Settings menu"

2) Serial link 1 only

3) Serial link 2 only

4) 37-pin I/O communication interface only

8.6.9 Input/Output: I/O connector

The detector is equipped, depending on its ordered configuration:

- with a 15-pin D-Sub I/O communication interface,
 - See chapter "15-pin Input/Output communication interface".
- with a 37-pin D-Sub I/O communication interface (with USB),
 - Refer to the operating instructions for the communication interface (see chapter "Applicable documents").
- with an Ethernet and a 37-pin D-Sub I/O communication interface (with USB).
 - Refer to the operating instructions for the communication interface (see chapter "Applicable documents").

Access: Settings Screen + Menu [Advanced] [Input/Output] [I/O Connector]

8.6.10 SD Card menu



Creating a library of the configurations for each application is recommended if the detector is used for more than one application.

Any SD card on the market can be used except cards with High Capacity technology, regardless of the memory size. Before use, make sure that the SD card is not locked (message "SD card not detected" displayed).

Access: Settings Screen + Menu [Advanced] [SD Card]

Load Parameters De- tector	Function to be launched Loading of the saved parameters (configuration) on the control panel SD card. Prerequisites: detector power on and in 'Stand-by' mode. After loading, the following parameters should be configured by the user: language, serial link, date, time, temperature unit and pressure unit.
Save Parameters De- tector	Function to be launched Save the leak detector parameters (configuration) on the control panel SD card. Prerequisites: detector power on and in "Stand-by" mode. All of the detector's parameters are saved except for the following: language, serial link, date, time, temperature unit and pressure unit.
Visualize * .BMP	Function to be launched View the saved ".bmp" files.

8.6.11 Service

Access to the Service menu is password protected.

Reserved for the Service Centers.

9 Maintenance/Replacement

Maintenance intervals and responsibilities

The detector maintenance operations are described in the Maintenance instructions for the detector.

The manual specifies:

- maintenance intervals,
- maintenance instructions,
- shutting the product down,
- tools and spare parts.

10 Accessories

Accessory	Description	Part Number
Standard remote control	Unit: mbar · l/s	106688
	Unit: Torr · l/s	108881
	Unit: Pa · m ³ /s	108880
	Unit: Pa · m ³ /s Japan model	106690
RC 10 remote control (wireless)	-	124193
Standard sniffer probe	-	Refer to Pfeiffer Vacuum catalogue
Standard sniffer probe extension	Length 10 m	090216
Smart sniffer probe	With 3 m connection cable	BG 449 207 -T
	With 5 m connection cable	BG 449 208 -T
	With 10 m connection cable	BG 449 209 -T
Calibrated leaks	Tracer gas: 100% ⁴ He	Refer to Pfeiffer Vacuum catalogue
Adaptor for external calibrated leak	DN 16 ISO-KF	127905
	DN 25 ISO-KF	127904
Spray gun	Standard model	112535
	Elite model	109951
Communication interface	37-pin Inputs/Outputs	126254
	37-pin Inputs/Outputs with Ethernet	126255
ECB Wi-Fi external communication box	-	125902
Inlet filters	Available in bronze or stainless steel, 5 to 20 µm mesh	Contact us
By-Pass Kit (37-pin I/O communication interface required)	Europe model	PT 445 411 -T
	US model	PT 445 413 -T
Bottle holder	-	126561
Locking clamp	DN 40 ISO-KF	118801
External gauge (37-pin I/O communication interface required)	CMRxxx / APRxxx / TPRxxx / PCRxxx model	Refer to Pfeiffer Vacuum catalogue
Cables for connecting detector/external gauge (for CMRxxx / APRxxx / TPRxxx / PCRxxx model)	Length 3 m	A333746
	Length 10 m	A333747
	Length 20 m	A333748

Tbl. 1: Accessories

11 Technical data and dimensions

11.1 General

Databases of technical characteristics of Pfeiffer Vacuum leak detectors:

- Technical characteristics according to:
 - AVS 2.3: Procedure for calibrating gas analyzers of the mass spectrometer type
 - EN 1518: Non-destructive testing. Leak testing. Characterization of mass spectrometer leak detectors
 - ISO 3530: Methods of calibrating leak detectors of the mass-spectrometer-type used in the field of vacuum technology
- Standard conditions: 20 °C, 5 ppm ⁴He ambient conditions, degassed detector
- Zero function or background suppression enabled
- Acoustic pressure level: distance in relation to the detector 1 m.

11.2 Technical characteristics

Characteristics	Unit	ASM 390	ASM 392
Dimensions (L x W x H)	mm	1072 x 455 x 1025	1072 x 455 x 1025
Connection flange (inlet)	-	DN 40 ISO-KF	DN 40 ISO-KF
Flow rate for He	l/s	10	25
Primary pump capacity	m ³ /h	35	35
Start-up time (20°C) without calibration	min	2	2
Sound level	dB (A)	54	55
Power consumption (230 V)	W	800	800
Maximum power consumption (230 V)	W	1600	1600
Maximum test pressure	hPa	20	20
Weight	kg	125 ¹⁾	130 ¹⁾
Detectable gas	-	⁴ He, ³ He, H ₂	⁴ He, ³ He, H ₂
Test method	-	Hard Vacuum Sniffing	Hard Vacuum Sniffing
Minimum detectable leak rate for ⁴ He (Sniffing detection)	mbar · l/s	1 · 10 ⁻⁸	1 · 10 ⁻⁸
	Pa · m ³ /s	1 · 10 ⁻⁹	1 · 10 ⁻⁹
Minimum detectable leak rate for ⁴ He (Hard vacuum detection)	mbar · l/s	1 · 10 ⁻¹²	1 · 10 ⁻¹²
	Pa · m ³ /s	1 · 10 ⁻¹³	1 · 10 ⁻¹³
Power supply ²⁾	V	100 – 240	100 – 240
Frequency	Hz	50/60	50/60

1) Maximum weight (detector + accessories + parts to be tested + etc.) = 200 kg

2) According to IEC/UL/CSA regulations, product can withstand a supply voltage variation of ± 10%.

Environmental conditions	Unit	ASM 390 - ASM 392
Use temperature	°C	10 – 35
Storage temperature	°C	-25 – +70
Maximum air hygrometry	-	95%, non-condensing
Maximum magnetic field	mT	3
Network overvoltage level	-	Category II
Use	-	Interior only
Maximum altitude above sea level	m	2000

Environmental conditions	Unit	ASM 390 - ASM 392
Pollution degree	-	II
Penetration protection rating	-	IP20

Tbl. 2: Environmental conditions

11.3 Units of pressure

Unit	mbar	bar	Pa	hPa	kPa	Torr / mm Hg
mbar	1	$1 \cdot 10^{-3}$	100	1	0.1	0.75
bar	1000	1	$1 \cdot 10^5$	1000	100	750
Pa	0.01	$1 \cdot 10^{-5}$	1	0.01	$1 \cdot 10^{-3}$	$7.5 \cdot 10^{-3}$
hPa	1	$1 \cdot 10^{-3}$	100	1	0.1	0.75
kPa	10	0.01	1000	10	1	7.5
Torr / mm Hg	1.33	$1.33 \cdot 10^{-3}$	133.32	1.33	0.133	1

1 Pa = 1 N/m²

Tbl. 3: Units of pressure and their conversion

11.4 Gas throughputs

Unit	mbar l/s	Pa m ³ /s	sccm	Torr l/s	atm cm ³ /s
mbar l/s	1	0.1	59.2	0.75	0.987
Pa m ³ /s	10	1	592	7.5	9.87
sccm	$1.69 \cdot 10^{-2}$	$1.69 \cdot 10^{-3}$	1	$1.27 \cdot 10^{-2}$	$1.67 \cdot 10^{-2}$
Torr l/s	1.33	0.133	78.9	1	1.32
atm cm ³ /s	1.01	0.101	59.8	0.76	1

Tbl. 4: Gas throughputs and their conversion

11.5 Dimensions

(mm)

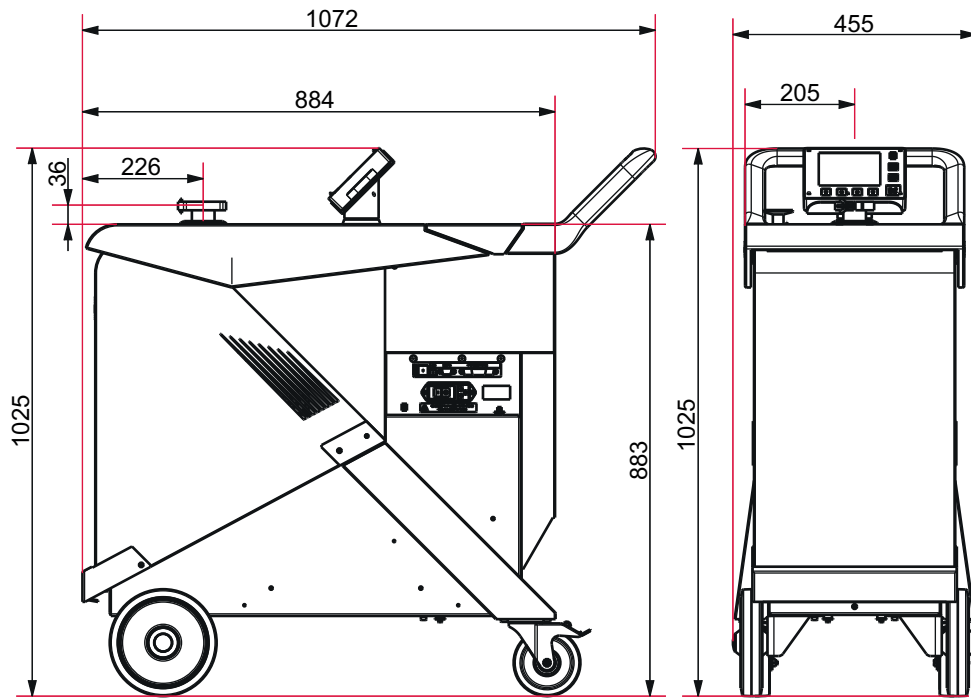

12 Appendix

12.1 Tree diagram of the Settings menu

Next tables indicate the default settings for the leak detector.

When the leak detector is switched off, values and parameters are saved for the next start-up.

Set point setting



- 1 → 1.0×10^{-07}
- 2 → 1.0×10^{-07}
- 3 → 1.0×10^{-07}

1 Exponent setting

2 Mantissa unit setting

3 Mantissa tenth setting

Access: Settings Screen + Menu [Setpoints]		Choice - Setting limit	
Audio	Status	Enabled ¹⁾ Disabled	
	Setting (If enabled)	0 – 9 3 ¹⁾	
Voice	Status	Enabled ¹⁾ Disabled	
	Setting (If enabled)	0 – 9 4 ¹⁾	
Pollution	Status	Enabled Disabled ¹⁾	
	Setting (If enabled)	$1 \cdot 10^{+19} - 1 \cdot 10^{-19}$ $1 \cdot 10^{-05}$ ¹⁾	
Hard Vacuum Set Points	Reject point	$1 \cdot 10^{+06} - 1 \cdot 10^{-13}$ $1 \cdot 10^{-08}$ ¹⁾	
Sniffer Set Points	Reject point	$1 \cdot 10^{+06} - 1 \cdot 10^{-12}$ $1 \cdot 10^{-04}$ ¹⁾	
	Probe Clogged	With standard probe	$1 \cdot 10^{+19} - 1 \cdot 10^{-19}$ $1 \cdot 10^{-06}$ ¹⁾
		With Smart probe	0 – 9999 10 ¹⁾
Other Set Points (If 37-pin I/O)	Set Point #2	$1 \cdot 10^{+19} - 1 \cdot 10^{-19}$ $1 \cdot 10^{-07}$ ¹⁾	
	Set Point #3	$1 \cdot 10^{+19} - 1 \cdot 10^{-19}$ $1 \cdot 10^{-07}$ ¹⁾	
	Set Point #4	$1 \cdot 10^{+19} - 1 \cdot 10^{-19}$ $1 \cdot 10^{-07}$ ¹⁾	
	Set Point #5	$1 \cdot 10^{+19} - 1 \cdot 10^{-19}$ $1 \cdot 10^{-07}$ ¹⁾	

1) Default setting

Access: Settings Screen + Menu [Setpoints]		Choice - Setting limit
Other Pressure Set Points (If 37-pin I/O)	Pressure Set Point #1	$5 \cdot 10^{-5} - 3 \cdot 10^{+2}$ 2 · 10⁺¹ ¹⁾
	Pressure set point #2	$5 \cdot 10^{-5} - 3 \cdot 10^{+2}$ 1 · 10⁺⁰ ¹⁾

1) Default setting

Tbl. 5: Default settings: 'Set Points' menu

Access: Settings Screen + Menu [Test]			Choice - Setting limit	
Method			Hard Vacuum ¹⁾ Sniffing	
HV/Sniffing Correction	Status		Enabled Disabled ¹⁾	
	Setting (If enabled)		$1 \cdot 10^{+20} - 1 \cdot 10^{-20}$ 1 · 10⁰ ¹⁾	
Mode	(If hard vacuum test method)		Gross Leak Normal High Sensitivity ¹⁾	
Type of probe	(If sniffing test method)		Standard ¹⁾ Smart	
Automatic cycle	Automatic cycle		Operator ¹⁾ Automatic	
	Setting (If automatic)	Evac. delay	Status Enabled ¹⁾ Disabled	
		Setting	0 – 1 h 10 s ¹⁾	
	Test Timer		0 – 1 h 10 s ¹⁾	
Inlet vent	Inlet vent		Operator ¹⁾ Automatic	
	Delay		0 – 2 s 0 s ¹⁾	
	Vent timer	Status		Enabled Disabled ¹⁾
		Setting (If automatic)		0 – 1 h 9 s ¹⁾
Memo Function	Active		No ¹⁾ Yes	
	Display Time	Status		Enabled Disabled ¹⁾
		Setting (If automatic)		0 – 1 h 10 s ¹⁾

1) Default setting

Access: Settings Screen + Menu [Test]			Choice - Setting limit
Zero Activation	Activation		None Operator ¹⁾ Automatic
	Zero Exit (if operator)		Press once ¹⁾ Press > 3 s
	Setting (If automatic)	Trigger	Timer ¹⁾ Set point
		Setting	If Timer 0 – 1 h 10 s ¹⁾
		If Set Point $1 \cdot 10^{+19} - 1 \cdot 10^{-19}$ 5 · 10⁻⁷ ¹⁾	
Bypass Option	Mode		No Bypass ¹⁾ Quick pumping Partial Flow
	Evac. delay		Off ¹⁾ On
Regeneration	Function launching		-
Massive Mode	Active		No Yes ¹⁾
	Sensitivity		High ¹⁾ Low

1) Default setting

Tbl. 6: Default settings: 'Test' menu

Access: Settings Screen + Menu [Spectro]		Choice - Setting limit
Tracer Gas		Helium 4 ¹⁾ Helium 3 Hydrogen
Filament selected		1 ¹⁾ 2
Filament		Off On ¹⁾
Filament status		0 – 100 % 100 % ¹⁾

1) Default setting

2) General information: read only

4) Information indicated on the calibrated leak used for calibration or on its calibration certificate

Access: Settings Screen + Menu [Spectro]		Choice - Setting limit
Calibrated leak	Tracer Gas	Helium 4 ¹⁾ Helium 3 Hydrogen
	Type	Internal ¹⁾ External Concentration
	Unit	mbar · l/s ¹⁾ Pa · m ³ /s Torr · l/s atm · cc/s ppm
	Leak Value	- ⁴⁾
	Calibration valve	Open Closed ¹⁾
	Loss Per Year (%)	0 – 99 6 ¹⁾
	Reference Temperature (°C)	0 – 99 23 ¹⁾
	Temperature Coefficient (%/°c)	0.0 – 9.9 3.0 ¹⁾
	Year	- ⁴⁾
	Internal temperature (°C) (if type = internal)	- ²⁾
	External temperature (°C) (if type = external)	0 – 99 20 ¹⁾

1) Default setting

2) General information: read only

4) Information indicated on the calibrated leak used for calibration or on its calibration certificate

Tbl. 7: Default settings: 'Spectro' menu

Access: Settings Screen + Menu [Maintenance]			Choice - Setting limit	
Detector			20 ^{1) 2)}	
Timers	Detector		20 ^{1) 2)}	
	Filament 1	Timer (h)	20 ^{1) 2)}	
		Reset counter	Function launching	-
	Filament 2	Timer (h)	0 ^{1) 2)}	
		Reset counter	Function launching	-
	Calibrated Leak		- ⁴⁾	
	Cycles	Timer (h)	0 ^{1) 2)}	
		Time interval		$1 \cdot 10^{+19} - 1$ 5 · 10⁺⁵ ¹⁾
		Reset counter	Function launching	-
	Prim. Pump	Timer (h)	20 ^{1) 2)}	
		Time interval (h)		0 – 99999 17200 ¹⁾
		Reset counter	Function launching	-
	Secondary Pump 1	Timer (h)	20 ^{1) 2)}	
		Time interval (h)		0 – 99999 17200 ¹⁾
		Reset counter	Function launching	-
		Speed (rpm)		- ²⁾
Secondary Pump 2 (ASM 392 only)	Timer (h)	20 ^{1) 2)}		
	Time interval (h)		0 – 99999 17200 ¹⁾	
	Reset counter	Function launching	-	
	Speed (rpm)		- ²⁾	
Detector Information	Access to general information		- ²⁾	
Pump Information	Primary Pump 1	Used	- ²⁾	
		Status	- ²⁾	
		Speed		- - ²⁾
		ACP information	Access to general information	- ²⁾
	Secondary Pump 1	Status		- ²⁾
		Rotation		- ²⁾
		Speed (rpm)		- ²⁾
		TMP information	Access to general information	- ²⁾
	Secondary Pump 2 (ASM 392 only)	Status		- ²⁾
		Rotation		- ²⁾
		Speed (rpm)		- ²⁾
		TMP information	Access to general information	- ²⁾
Events History			Empty ¹⁾	
Calibration History			Empty ¹⁾	
Burn-in	Function launching		-	

1) Default setting

2) General information: read only

4) Information indicated on the calibrated leak used for calibration or on its calibration certificate

Access: Settings Screen + Menu [Maintenance]		Choice - Setting limit	
Maintenance Secondary Pump and Cell	Function launching	-	
Last Maintenance	Maintenance work 1	Date	-
		Total hours	-
		Inspected by	-
	Maintenance work 2	Date	-
		Total hours	-
		Inspected by	-
	Maintenance work 3	Date	-
		Total hours	-
		Inspected by	-

- 1) Default setting
- 2) General information: read only
- 4) Information indicated on the calibrated leak used for calibration or on its calibration certificate

Tbl. 8: Default settings: 'Maintenance' menu

Access: Settings Screen + Menu [Configuration]		Choice - Setting limit
Unit/Date/ Language	Unit	- ³⁾ mbar · l/s Pa · m ³ /s Torr · l/s atm · cc/s ppm sccm sccs mtorr · l/s
	Date	- ³⁾ Format: Month Day Year (mm/dd/yyyy)
	Time	- ³⁾ Format: Hour Minute Second (hh:mm:ss)
	Language	- ³⁾ English French German Italian Chinese Japanese Korean Spanish Russian
Function keys	Setting	-

- 1) Default setting
- 2) General information: read only
- 3) No default setting: setting performed by the user at the 1st detector start-up
- 4) Information indicated on the calibrated leak used for calibration or on its calibration certificate

Access: Settings Screen + Menu [Configuration]				Choice - Setting limit
Application windows	Standard Window Parameters (main screen)	Leak rate bar-graph	Zoom on Set Point	No ¹⁾ Yes
			Low Decade	$1 \cdot 10^{+5} - 1 \cdot 10^{-13}$ 1 · 10⁺¹² ¹⁾
			High Decade	$1 \cdot 10^{+6} - 1 \cdot 10^{-12}$ 1 · 10⁻² ¹⁾
		Stand-By Value		Hide Show ¹⁾
		Inlet Pressure		Hide Show ¹⁾
		Extra Pressure		Hide ¹⁾ Cell Ext
		Lower Display Limit	Hard Vacuum	$1 \cdot 10^{+19} - 1 \cdot 10^{-19}$ 1 · 10⁻¹³ ¹⁾
			Sniffer	$1 \cdot 10^{+19} - 1 \cdot 10^{-19}$ 1 · 10⁻⁷ ¹⁾
		Show 2 nd digit		Hide Show ¹⁾
	Standard (Principal)	Access	Enabled ^{1) 2)}	
		Order	1st ^{1) 2)}	
	Graph	Access	Disabled Enabled ¹⁾	
		Order (If shown)	2 nd – 4 th 2nd ¹⁾	
Synoptic	Access	Disabled Enabled ¹⁾		
	Order (If shown)	2 nd – 4 th 3rd ¹⁾		
Settings	Access	Disabled Enabled ¹⁾		
	Order (If shown)	2 nd – 4 th 4th ¹⁾		

1) Default setting

2) General information: read only

3) No default setting: setting performed by the user at the 1st detector start-up

4) Information indicated on the calibrated leak used for calibration or on its calibration certificate

Access: Settings Screen + Menu [Configuration]		Choice - Setting limit	
Screen Settings	Brightness	High Low	
	Contrast	0 – 100 50 % ¹⁾	
	Panel off	None ¹⁾ 15 min 30 min 1 h 2 h 4 h	
	Paging Function	Without remote control detected	-
		With remote control detected	No ¹⁾ Yes
	Reset panel parameters	Function launching	-
Access / Password	Password	0 – 9999 5555 ¹⁾	
	'Set Points' menu access	Lock Unlock ¹⁾	
	'Test' menu access	Lock Unlock ¹⁾	
	'Spectro' menu access	Lock Unlock ¹⁾	
	'Maintenance' menu access	Lock Unlock ¹⁾	
	'Configuration' menu access	Lock Unlock ¹⁾	
	'Advanced' menu access	Lock Unlock ¹⁾	
	User Level	Restricted Access Medium Access Full Access ¹⁾	
	Change password	0 – 99999	

1) Default setting

2) General information: read only

3) No default setting: setting performed by the user at the 1st detector start-up

4) Information indicated on the calibrated leak used for calibration or on its calibration certificate

Tbl. 9: Default settings: 'Configuration' menu

Access: Settings Screen + Menu [Advanced]			Choice - Setting limit		
Leak detection	Start-Up Timer		0 – 1h 10 s ¹⁾		
	Background Suppression	Activation	Off On ¹⁾		
	Crossover Pressures	Gross Leak		- ²⁾	
		Normal		- ²⁾	
		High Sensitivity		- ²⁾	
	Calibration	Calibration		Operator Start-up ¹⁾ Manual	
		Calibration checking	Checking		Operator ¹⁾ Automatic
			Frequency (If automatic)	Cycles	0 – 9999 50 Cy. ¹⁾
				Hours	0 – 9999 10h ¹⁾
	Analyzer Cell	Filament selected		1 ¹⁾ 2	
		Filament		Off On ¹⁾	
		Triode Pressure		- ²⁾	
		Electric Zero		- ²⁾	
		Calibration valve		Off ¹⁾ On	
		Target Value		- ²⁾	
Acceleration Voltage (V)		- ²⁾			
Emission (mA)		- ²⁾			
Sensitivity Coefficient		- ²⁾			
Internal Temperature (°C)		- ²⁾			
Internal Pirani Calibration	Function launching		-		
External gauge	Gauge		None ¹⁾ TPR PCR Linear		
	External Pressure (mbar)		- ²⁾		
	Pressure Inlet Source		Internal ¹⁾ External		
	Full scale (mbar) (if 'linear')		0.1 – 5000 - ⁷⁾		
Purge valve		Automatic ¹⁾ Open Closed			

1) Default setting

2) General information: read only

3) No default setting: setting performed by the user at the 1st detector start-up

4) Information indicated on the calibrated leak used for calibration or on its calibration certificate

5) See the I/O communication interface operating instructions

6) No default setting: depending on allocation

7) No default setting

Access: Settings Screen + Menu [Advanced]			Choice - Setting limit
Input/Output (15-pin I/O)	Serial link 1	Type	Serial ¹⁾
		Parameters	Basic Spreadsheet Advanced ¹⁾ Export. Data RC 500 WL RC 500 HLT 5xx Ext. Module HLT 2xx
		Handshake	None ¹⁾ XON XOFF
		Power Pin 9	5 V ¹⁾
	Serial Link 2	Type	Not used ¹⁾
I/O Connector	Analog Output	- ⁵⁾	
Input/Output (37-pin I/O)	Serial link 1	Type	Serial ¹⁾ USB
		Parameters	Basic Spreadsheet Advanced ¹⁾ Export. Data RC 500 WL RC 500 HLT 5xx Ext. Module HLT 2xx
		Handshake	None ¹⁾ XON XOFF
	Power Pin 9	5 V ¹⁾	

1) Default setting

2) General information: read only

3) No default setting: setting performed by the user at the 1st detector start-up

4) Information indicated on the calibrated leak used for calibration or on its calibration certificate

5) See the I/O communication interface operating instructions

6) No default setting: depending on allocation

7) No default setting

Access: Settings Screen + Menu [Advanced]				Choice - Setting limit
Input/Output (37-pin I/O)	Serial Link 2	Type		Not used ¹⁾ USB Network
		Parameters	Mode	Basic Spreadsheet Advanced ¹⁾ Export. Data HLT 5xx
			Handshake	None ¹⁾ XON XOFF
	I/O Connector	Quick View	I/O set in the 37-pin D-Sub connector	- ²⁾
		Analog output		- ⁵⁾
		Digital input		- ⁵⁾
		Digital Transistor Output		- ⁵⁾
		Digital Relay Output		- ⁵⁾
		Select Default Configuration	Function launching	-
		Others Configurations		Config #142 Config #182 Config #HLT5xx
Load Config. from SD Card	Function launching	-		
SD Card	Load LD Parameter	Function launching	-	
	Save LD Parameter	Function launching	-	
	Visualize *.BMP	Function launching	-	
Service	Access to 'Service' menu with password. Reserved for our Service Centers.			

1) Default setting

2) General information: read only

3) No default setting: setting performed by the user at the 1st detector start-up

4) Information indicated on the calibrated leak used for calibration or on its calibration certificate

5) See the I/O communication interface operating instructions

6) No default setting: depending on allocation

7) No default setting

Tbl. 10: Default settings: 'Advanced' menu

Access: Press the graph, then [Range]		Choice - Setting limit
Display Time		Rapid / 1 min ¹⁾ / 1 min / 2 min / 3 min / 6 min / 12 min / 30 min / 1 h / 2 h
Auto scale	Status	Enabled Disabled ¹⁾
	Setting (If enabled)	2 decades 4 decades ¹⁾

1) Default setting

Access: Press the graph, then [Range]		Choice - Setting limit	
Leak Rate	Display status	Enabled ¹⁾ Disabled	
	Setting (If enabled)	Low Decade	$10^{-13} - 10^{+5}$ $1 \cdot 10^0$ ¹⁾
		High Decade	$10^{-12} - 10^{+6}$ $1 \cdot 10^{-4}$ ¹⁾
Pressure	Display status	Enabled Disabled ¹⁾	
	Setting (If enabled)	High decade	$10^{-2} - 10^{+6}$ $1 \cdot 10^{-3}$ ¹⁾

1) Default setting

Tbl. 11: Initial settings: Graph screen - Graph parameters

Access: Press the graph and then [Record]	Choice - Setting limit
Duration	0.2 s / 0.5 s / 1 s ¹⁾ / 2 s / 5 s / 10 s / 20 s / 30 s
Capacity	- ²⁾

1) Default setting

Tbl. 12: Initial settings: Graph screen - Recording parameters

12.2 15-pin Input/Output communication interface

From the 'Settings' screen, press [Advanced] [Input/Output] [I/O Connector].

12.2.1 Cable characteristics

NOTICE

Risk of electromagnetic disturbance

Voltages and currents can induce a multitude of electromagnetic fields and interference signals. Installations that do not comply with the EMC regulations can interfere with other equipment and the environment in general.

- ▶ Use shielded cables and connections for the interfaces in interference-prone environments.

NOTICE

Safety Extra-Low Voltage circuits

The remote control circuits are equipped with dry contact outputs (30 V - 1 A max). Overvoltages and overcurrents can result in internal electrical damage. Users must observe the following wiring conditions:

- ▶ Connect these outputs in accordance with the rules and protection of Safety Extra-Low Voltage (SELV) circuits.
- ▶ The voltage applied to these contacts should be less than 30 V and the current less than 1 A.

- ▶ 15-pin D-sub male connector for IP 20.

Inputs	Logics	14	Starting the test
	Analogs	5	Disabled

Outputs	Logics	6	Test threshold crossed
		7	ASM xxx: Selected test mode reached ASI xx: Detector ready
	Analog	9	Mantissa (0/10 V) ¹⁾
		10	Leak rate (logarithmic) ¹⁾
		11	5 VDC - 750 mA max.
		12	Exponent (0/10 V)
Mass		1 - 2 - 3 - 4 - 13	-
Headset		8	Headset+ ²⁾
		15	Headset- ²⁾

1) By default: parameterizable by the customer

2) To enable the audio/headset output, it is necessary to issue a command RS-232 “=HPD” to the detector: this command will disable the loudspeaker. To disable the audio/headset output, it is necessary to issue a command RS-232 “=HPE” to the detector: this command will enable the loudspeaker.

12.2.2 Interface

See chapter “Connection interface”.

12.2.3 Save

See chapter “SD card menu”.

A save of all the set I/O is automatically proposed at the menu exit if a parameter has been modified.

- ▶ Enter the file name and valid the save (“.IOP” file).

12.2.4 Setting

3 analog outputs (Analog Output)

9-gnd	1. Select the value to be allocated. ¹⁾ 2. Depending on the value, configure the low decade.
10-gnd	1. Select the value to be allocated. ¹⁾ 2. Depending on the value, configure the low decade.
12-gnd	Output allocated to ‘Exponent’

1) See table below

$$\overset{\textcircled{x}}{x} = \overset{\textcircled{a}}{a} \cdot 10^{\overset{\textcircled{b}}{b}}$$

1 2 3

Leak rate formula

- 1 Leak rate 3 Exponent
2 Mantissa

The low decade is the decade corresponding with 0 V.

Value	Function
Mantissa	1/10 V ¹⁾
Exponent	1/10 V ¹⁾
Logarithmic	1/10 V ¹⁾
He compound	0/10 V (compound exponent, mantissa) ¹⁾
1) See chapter ‘Formulas’	

12.2.5 Formulas

Mantissa (1/10 V)	
The "Mantissa" output corresponds with the leak rate mantissa.	
Formula	U = Voltage measured (V) on analog output Mantissa = U
Examples	<ul style="list-style-type: none"> • U = 3.5 V -> Mantissa = 3.5 • U = 6.9 V -> Mantissa = 6.9
Exponent (0/10 V)	
The "Exponent" output corresponds with the leak rate exponent.	
<ul style="list-style-type: none"> • The Exponent increases by 1 V per decade. • The starting decade corresponds with the 10 V. 	
Formula	U = Voltage measured (V) on analog output D_0 = Low decade for 0 V Exponent = 10 - U + D_0
Examples	<p>Example 1</p> <p>Low decade at 10^{-12} (10 V = -12) -> $D_0 = -12$</p> <ul style="list-style-type: none"> • U = 7 V -> Exponent = 10 - 7 - 12 -> Exponent = -9 • U = 2 V -> Exponent = 10 - 2 - 12 -> Exponent = -4 <p>Example 2</p> <p>Low decade at 10^{-10} (10 V = -10) -> $D_0 = -10$</p> <ul style="list-style-type: none"> • U = 7 V -> Exponent = 10 - 7 - 10 -> Exponent = -7 • U = 2 V -> Exponent = 10 - 2 - 10 -> Exponent = -2
Logarithmic (0/10 V)	
The "Logarithmic" output corresponds with the leak rate value.	
<ul style="list-style-type: none"> • The leak rate increases by 1 V per decade. • The starting decade corresponds with 0 V. 	
Formula	U = Voltage measured (V) on analog output D_0 = Low decade for 0 V Mantissa = $10^{(U - \text{Valeur entière (U)})}$ Exponent = Integer value (U) + D_0 Leak rate = Mantissa x 10^{Exponent}

Logarithmic (0/10 V)

Examples

Example 1

Low decade at 10^{-12} ($0\text{ V} = 1 \cdot 10^{-12}$) $\rightarrow D_0 = -12$

- $V = 3.91\text{ V} \rightarrow \text{Leak rate} = 10^{(3.91 - 3)} \times 10^{(3 - 12)} = 8.13 \cdot 10^{-9}$
- $V = 8.25\text{ V} \rightarrow \text{Leak rate} = 10^{(8.25 - 8)} \times 10^{(8 - 12)} = 1.78 \cdot 10^{-4}$

Example 2

Low decade at 10^{-10} ($0\text{ V} = 1 \cdot 10^{-10}$) $\rightarrow D_0 = -10$

- $V = 3.91\text{ V} \rightarrow \text{Leak rate} = 10^{(3.91 - 3)} \times 10^{(3 - 10)} = 8.13 \cdot 10^{-7}$
- $V = 8.25\text{ V} \rightarrow \text{Leak rate} = 10^{(8.25 - 8)} \times 10^{(8 - 10)} = 1.78 \cdot 10^{-2}$

Graph

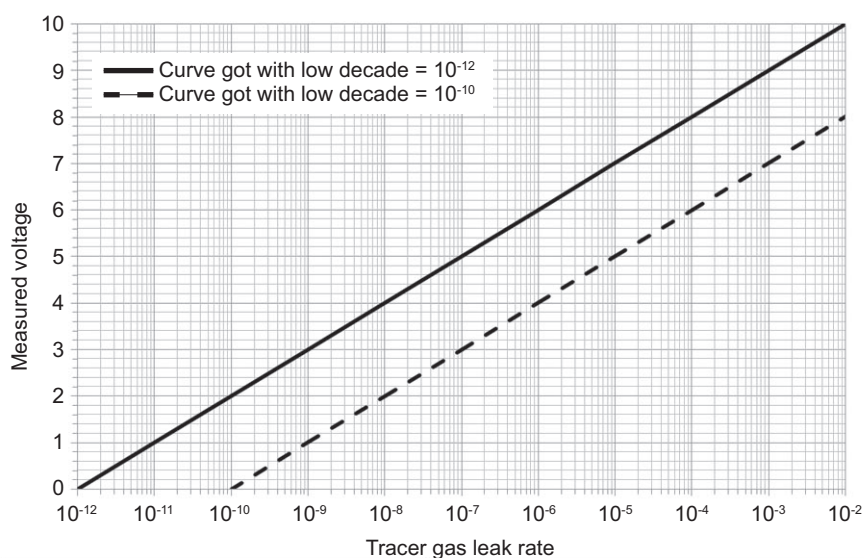
**Inlet pressure**

The "Inlet Pressure" output corresponds with the inlet pressure source.

The leak detector is equipped with an internal gauge (2.5 V/8.5 V).

Formula

 $U = \text{Voltage measured (V) on analog output}$ $\text{Inlet pressure} = 10^{(U - 5.5)} \text{ hPa}$

Graph

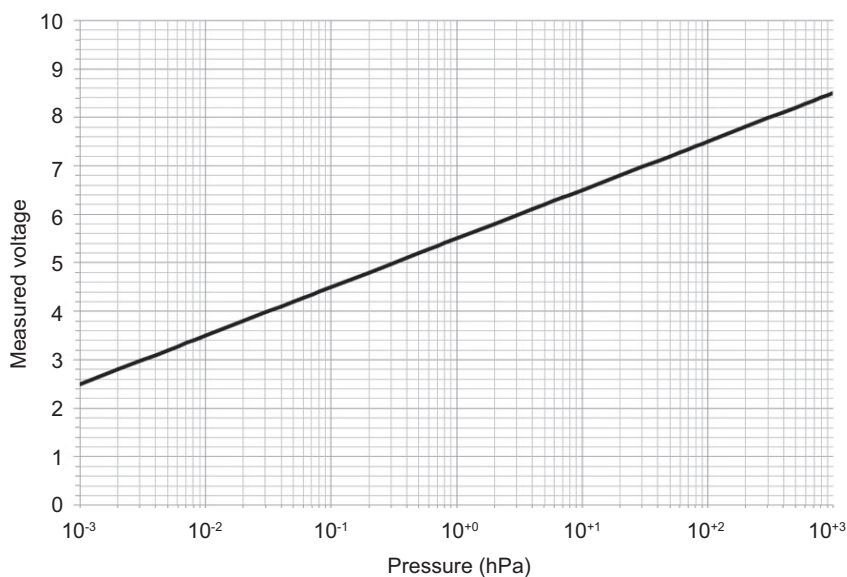
**12.3 RS-232 Serial link**

Refer to the Operating instructions of the RS-232 Serial link (see chapter "Applicable documents").

12.3.1 Cable characteristics

Refer to the RS-232 serial link operating instructions (see chapter "Applicable documents").

12.3.2 Interface

See chapter "Connection interface".

12.3.3 Setting

From the "Settings" screen, press **[Advanced] [Input/Output]** then **[Serial Link 1]** or **[Serial Link 2]**.

Type	Set the type of serial link 'Serial'. ¹⁾
Parameter	Set the serial link mode. ¹⁾

1) See detail below

Type

Type	Set the 2 serial links (1) or (2) according to their use. ¹⁾
------	---

1) See detail below

Use	Possible allocation		Type to select
	Serial Link 1	Serial Link 1	
RS-232	Yes	No	Serial
Bluetooth transmitter for RC 500 WL remote ¹⁾	Yes	No	Serial
RC 10 remote control ¹⁾	Yes	No	Serial
ECB WiFi remote ¹⁾	Yes	No	Serial

1) Accessory

Parameters

From the "Settings" screen, press **[Advanced] [Input/Output] [Serial Link 1]** or **[Serial Link 2], [Parameters]**.

Parameters	Set the serial link mode ¹⁾ .
------------	--

1) See detail below

Modes list: according to leak detector model, some modes are not available.

Mode	Description
Basic	Continuous acquisition of data according to a defined time duration. At any time, a command can be sent to the leak detector. 5 V power supply available.
Spreadsheet	Variant on the Basic mode. Continuous data acquisition, formatted in a spreadsheet such as Excel Microsoft® Office or other similar software. 5 V power supply available.
Advanced	Full control of the detector by a supervisor The detector sends information at the supervisor's request. 5 V power supply available. Recommended mode for automatic systems.
Export Data	Export, via a PC, of "tickets" issued by the detector after: <ul style="list-style-type: none"> • Calibration with an internal/external calibrated leak, • Calibration control with an internal leak, • A test. 5 V power supply available. Serial links 1 and 2 must not be in "Export Data" mode at the same time.

Mode	Description
RC 500 WL	Use of a wireless remote control (model RC 500 WL). 5 V power supply available.
RC 500	Use of a wired remote control (model RC 500). 24 V power supply available
HLT 5xx	Protocol for compatibility with the HLT 5xx detector protocol. 5 V power supply available. List of orders for the protocol compatible. To refer to Operating instructions - RS-232 Serial link (see chapter "Applicable documents").
HLT 2xx	Protocol for compatibility with the HLT 2xx.detector protocol. 5 V power supply available. List of orders for the protocol compatible. To refer to Operating instructions - RS-232 Serial link (see chapter "Applicable documents").
Module Ext.	Full control of the detector by a supervisor. The detector sends information at the supervisor's request. 24 V power supply available A 24 V power supply is required for using an external module (example: profi-bus).

This authorizes the application of the Certification Mark(s) shown below to the models described in the Product(s) Covered section when made in accordance with the conditions set forth in the Certification Agreement and Listing Report. This authorization also applies to multiple listee model(s) identified on the correlation page of the Listing Report.

This document is the property of Intertek Testing Services and is not transferable. The certification mark(s) may be applied only at the location of the Party Authorized To Apply Mark.

Applicant: PFEIFFER VACUUM SAS
Address: 98 avenue de Brogny - BP 2069
74000 Annecy Cedex
Country: France
Contact: Mr Julien Coulomb
Phone: + 33 4 50 65 75 39
FAX: /
Email: julien.coulomb@pfeiffer-vaccum.fr

Manufacturer: PFEIFFER VACUUM SAS
Address: 98 avenue de Brogny - BP 2069
74000 Annecy Cedex
Country: France
Contact: Mr Julien Coulomb
Phone: + 33 4 50 65 75 39
FAX: /
Email: julien.coulomb@pfeiffer-vaccum.fr

Party Authorized To Apply Mark: Same as Manufacturer
Report Issuing Office: Intertek, Paris, France

Control Number: 3026716

Authorized by: _____



Ulla-Pia Johansson-Nilsson
for Dean Davidson, Certification Manager



This document supersedes all previous Authorizations to Mark for the noted Report Number.

This Authorization to Mark is for the exclusive use of Intertek's Client and is provided pursuant to the Certification agreement between Intertek and its Client. Intertek's responsibility and liability are limited to the terms and conditions of the agreement. Intertek assumes no liability to any party, other than to the Client in accordance with the agreement, for any loss, expense or damage occasioned by the use of this Authorization to Mark. Only the Client is authorized to permit copying or distribution of this Authorization to Mark and then only in its entirety. Use of Intertek's Certification mark is restricted to the conditions laid out in the agreement and in this Authorization to Mark. Any further use of the Intertek name for the sale or advertisement of the tested material, product or service must first be approved in writing by Intertek. Initial Factory Assessments and Follow up Services are for the purpose of assuring appropriate usage of the Certification mark in accordance with the agreement, they are not for the purposes of production quality control and do not relieve the Client of their obligations in this respect.

Intertek Testing Services NA Inc.
545 East Algonquin Road, Arlington Heights, IL 60005
Telephone 800-345-3851 or 847-439-5667 Fax 312-283-1672

Standard(s):	Safety Requirements For Electrical Equipment For Measurement, Control, And Laboratory Use – Part 1: General Requirements [UL 61010-1:2012 Ed.3+R:29Apr2016] Safety Requirements For Electrical Equipment For Measurement, Control, And Laboratory Use – Part 1: General Requirements (R2017) [CSA C22.2#61010-1-12:2012 Ed.3+U1;U2]
Product:	Mobile gas leak detector
Brand Name:	
Models:	ASM390 and ASM392



Global Semiconductor Safety Services

CERTIFICATE OF CONFORMANCE

To SEMI S2-0715 and SEMI S8-0915 Guidelines

September 13, 2017

Company Name & Location:	Pfeiffer Vacuum 98 avenue de Brogny 74009 Annecy France
Place of Manufacturing:	Annecy, France
Document Number:	102846706MPK-003a
Model:	Helium Leak Detector, ASM 390
Investigated in accordance with:	SEMI S2-0715 / SEMI S8-0915

Intertek Global Semiconductor Safety Services

UK Declaration of Conformity

This declaration of conformity has been issued under the sole responsibility of the manufacturer.

Declaration for product(s) of the type:

Leak detector

ASM 390

ASM 392

We hereby declare that the listed product satisfies all relevant provisions of the following **British Directives**.

Supply of Machinery (Safety) Regulations 2008

Electromagnetic Compatibility Regulations 2016

The Restriction of the Use of Certain Hazardous Substances in Electrical and Electronic Equipment Regulations 2012

Applied standards and specifications:

EN 61000-6-2: 2005

EN 61000-6-4: 2007

EN 60204-1: 2006

ENV 50204: 1996

The manufacturer's authorized representative in the United Kingdom and the authorized agent for compiling the technical documentation is Pfeiffer Vacuum Ltd, 16 Plover Close, Interchange Park, MK169PS Newport Pagnell.

Signature:



(Guillaume Kreziak)
Managing Director

Pfeiffer Vacuum SAS
98, avenue de Brogny
74009 Annecy cedex
France
B.P. 2069

Annecy, 2023-02-16

**UK
CA**

EC Declaration of Conformity

This declaration of conformity has been issued under the sole responsibility of the manufacturer.

Declaration for product(s) of the type:

Leak detector

ASM 390

ASM 392

We hereby declare that the listed product satisfies all relevant provisions of the following **European Directives**.

Machinery 2006/42/EC (Annex II, no. 1 A)

Electromagnetic compatibility 2014/30/EU

Restriction of the use of certain hazardous substances 2011/65/EU

Harmonized standards and national standards and specifications applied:

EN 61010-1: 2011

EN 61326-1: 2013

EN 60204-1: 2006

EN 50581: 2013

The person responsible for compiling the technical file is Mr. Cyrille Nominé, Pfeiffer Vacuum SAS, 98, avenue de Brogny B.P. 2069, 74009 Annecy cedex, France.

Signature:



(Guillaume Kreziak)
Managing Director

Pfeiffer Vacuum SAS
98, avenue de Brogny
74009 Annecy cedex
France
B.P. 2069

Annecy, 2023-03-30



VACUUM SOLUTIONS FROM A SINGLE SOURCE

Pfeiffer Vacuum stands for innovative and custom vacuum solutions worldwide, technological perfection, competent advice and reliable service.

COMPLETE RANGE OF PRODUCTS

From a single component to complex systems:

We are the only supplier of vacuum technology that provides a complete product portfolio.

COMPETENCE IN THEORY AND PRACTICE

Benefit from our know-how and our portfolio of training opportunities!

We support you with your plant layout and provide first-class on-site service worldwide.

Ed. 05 - Date 2023/04 - P/N:1263480EN



Are you looking for a
perfect vacuum solution?
Please contact us

Pfeiffer Vacuum GmbH
Headquarters • Germany
T +49 6441 802-0
info@pfeiffer-vacuum.de

www.pfeiffer-vacuum.com