



OPERATING INSTRUCTIONS

EN

Translation of the Original

MVP 015-4 DC NEO

Diaphragm pump

Dear Customer,

Thank you for choosing a Pfeiffer Vacuum product. Your new diaphragm pump is designed to support you with its performance, perfect operation and without impacting your individual application. The name Pfeiffer Vacuum stands for high-quality vacuum technology, a comprehensive and complete range of top-quality products and first-class service. From this extensive, practical experience we have gained a large volume of information that can contribute to efficient deployment and to your personal safety.

In the knowledge that our product must avoid consuming work output, we trust that our product can offer you a solution that supports you in the effective and trouble-free implementation of your individual application.

Please read these operating instructions before putting your product into operation for the first time. If you have any questions or suggestions, please feel free to contact info@pfeiffer-vacuum.de.

Further operating instructions from Pfeiffer Vacuum can be found in the [Download Center](#) on our website.

Disclaimer of liability

These operating instructions describe all models and variants of your product. Note that your product may not be equipped with all features described in this document. Pfeiffer Vacuum constantly adapts its products to the latest state of the art without prior notice. Please take into account that online operating instructions can deviate from the printed operating instructions supplied with your product.

Furthermore, Pfeiffer Vacuum assumes no responsibility or liability for damage resulting from the use of the product that contradicts its proper use or is explicitly defined as foreseeable misuse.

Copyright

This document is the intellectual property of Pfeiffer Vacuum and all contents of this document are protected by copyright. They may not be copied, altered, reproduced or published without the prior written permission of Pfeiffer Vacuum.

We reserve the right to make changes to the technical data and information in this document.

Table of contents

1	About this manual	8
1.1	Validity	8
	1.1.1 Applicable documents	8
	1.1.2 Variants	8
1.2	Target group	8
1.3	Conventions	8
	1.3.1 Instructions in the text	8
	1.3.2 Pictographs	9
	1.3.3 Stickers on product	9
	1.3.4 Abbreviations	10
2	Safety	11
2.1	General safety information	11
2.2	Safety instructions	11
2.3	Safety precautions	13
2.4	Limits of use of the product	14
2.5	Proper use	14
2.6	Foreseeable improper use	15
2.7	Personnel qualification	15
	2.7.1 Ensuring personnel qualification	15
	2.7.2 Personnel qualification for maintenance and repair	16
	2.7.3 Advanced training with Pfeiffer Vacuum	16
3	Product description	17
3.1	Function	17
	3.1.1 Actuator	17
	3.1.2 Pumping system	17
	3.1.3 Cooling	17
	3.1.4 Gas ballast	18
	3.1.5 Pressure sensor	18
3.2	Connections	18
3.3	Identifying product	18
3.4	Scope of delivery	18
4	Transportation and Storage	19
4.1	Transporting the vacuum pump	19
4.2	Storing vacuum pump	19
5	Installation	20
5.1	Installing the vacuum pump	20
5.2	Connecting the vacuum side	20
5.3	Connect exhaust side	20
5.4	Establishing the electric connection	21
	5.4.1 Grounding vacuum pump	21
	5.4.2 Establishing electric connection	22
6	Interfaces	24
6.1	"Remote" interface	24
	6.1.1 Voltage supply	25
	6.1.2 Inputs	25
	6.1.3 Outputs	25
	6.1.4 RS-485	26
6.2	Interface RS-485	26
6.3	Cross-linking via RS-485 connection	26
6.4	Pfeiffer Vacuum protocol for RS-485 interface	27
	6.4.1 Telegram frame	27
	6.4.2 Telegram description	27

	6.4.3 Telegram example 1	28
	6.4.4 Telegram example 2	28
	6.4.5 Data types	28
7	Parameter set	30
	7.1 General	30
	7.2 Control commands	30
	7.3 Status requests	31
	7.4 Reference value inputs	32
8	Operation	33
	8.1 Commissioning vacuum pump	33
	8.2 Switching on the vacuum pump	33
	8.3 Configuring connections with Pfeiffer Vacuum parameter set	34
	8.3.1 Configuring the digital outputs	34
	8.3.2 Selecting the interfaces	34
	8.3.3 Configuring accessories	34
	8.4 Operating modes	35
	8.4.1 Normal operation	35
	8.4.2 Stand-by operation	36
	8.4.3 Speed actuator operation	36
	8.5 Determining effective pressure with correction factors	36
	8.6 Operation monitoring	37
	8.6.1 Operating mode display via LED	37
	8.6.2 Temperature monitoring	38
	8.7 Switching off the vacuum pump	38
9	Maintenance	39
	9.1 Maintenance instructions	39
	9.2 Checklist for inspection and maintenance	40
	9.3 Change the diaphragms and valves	41
	9.3.1 Mounting/removing interconnection hose	41
	9.3.2 Dismantling diaphragm head and valves	42
	9.3.3 Cleaning and replacing the diaphragms and valves	42
	9.3.4 Mounting diaphragm head and valves	43
10	Decommissioning	44
11	Recycling and disposal	45
	11.1 General disposal information	45
	11.2 Dispose of diaphragm pumps	45
12	Malfunctions	46
	12.1 General	46
	12.2 Error codes	47
13	Service solutions by Pfeiffer Vacuum	49
14	Spare part packages	51
15	Accessories	52
	15.1 Accessory information	52
	15.2 Ordering accessories	52
16	Technical data and dimensions	53
	16.1 General	53
	16.2 Technical data	53
	16.3 Substances in contact with the media	54
	16.4 Dimensions	55
	Certificate	56

EC Declaration of Conformity	57
UK Declaration of Conformity	58

List of tables

Tbl. 1:	Variants	8
Tbl. 2:	Stickers on product	9
Tbl. 3:	Abbreviations used in this document	10
Tbl. 4:	Permissible ambient conditions	14
Tbl. 5:	Connection description of the electronic drive unit	18
Tbl. 6:	Pin assignment of the D-Sub socket, 15-pin	25
Tbl. 7:	Output DO1/pin 8	25
Tbl. 8:	Output DO2/pin 9	26
Tbl. 9:	Features of the RS-485 interface	26
Tbl. 10:	Explanation and meaning of the parameters	30
Tbl. 11:	Parameter set Control commands	31
Tbl. 12:	Parameter set Status requests	32
Tbl. 13:	Parameter set Reference value inputs	32
Tbl. 14:	Factory setting of the electronic drive unit for diaphragm pumps when delivered	33
Tbl. 15:	Configure parameters [P:019] and [P:024]	34
Tbl. 16:	Parameters [P:060] and [P:061]	34
Tbl. 17:	Correction factor for pressure range < 1 hPa	37
Tbl. 18:	Behavior and meaning of the LEDs of the electronic drive unit	38
Tbl. 19:	Typical service life with normal use	39
Tbl. 20:	Maintenance intervals	41
Tbl. 21:	Troubleshooting on diaphragm pumps	47
Tbl. 22:	Error messages for vacuum pump	47
Tbl. 23:	Warning messages for vacuum pump	48
Tbl. 24:	Spare parts	51
Tbl. 25:	Accessories MVP 015-4 DC	52
Tbl. 26:	Conversion table: Pressure units	53
Tbl. 27:	Conversion table: Units for gas throughput	53
Tbl. 28:	Technical data MVP 015-4 DC	54
Tbl. 29:	Materials that make contact with the process media	54

List of figures

Fig. 1:	Position of the stickers on the product	10
Fig. 2:	Diaphragm pump design	17
Fig. 3:	Connecting grounding cable	21
Fig. 4:	Connection with turbopump, power supply pack and controller	22
Fig. 5:	Connection to control unit with integrated power supply pack	23
Fig. 6:	Pins of the D-Sub socket, 15-pin	24
Fig. 7:	Cross-linking via RS-485 interface	27
Fig. 8:	Accessory connector assignment	35
Fig. 9:	Displayed pressure	37
Fig. 10:	Mounting/removing interconnection hose	41
Fig. 11:	Diaphragm head and valves	42
Fig. 12:	Spare parts	51
Fig. 13:	Dimensions MVP 015-4 DC	55

1 About this manual



IMPORTANT

Read carefully before use.
Keep the manual for future consultation.

1.1 Validity

These operating instructions are a customer document of Pfeiffer Vacuum. The operating instructions describe the functions of the named product and provide the most important information for the safe use of the device. The description is written in accordance with the valid directives. The information in these operating instructions refers to the product's current development status. The document shall remain valid provided that the customer does not make any changes to the product.

1.1.1 Applicable documents

Designation	Document
Declaration of conformity	A component of these operating instructions

1.1.2 Variants

These instructions apply to MVP 015-4 DC diaphragm pumps.

Article number	Designation
PK T05 163	Standard version
PK T05 164	Version without rubber feet

Tbl. 1: Variants

1.2 Target group

These operating instructions are aimed at all persons performing the following activities on the product:

- Transportation
- Setup (Installation)
- Usage and operation
- Decommissioning
- Maintenance and cleaning
- Storage or disposal

The work described in this document is only permitted to be performed by persons with the appropriate technical qualifications (expert personnel) or who have received the relevant training from Pfeiffer Vacuum.

1.3 Conventions

1.3.1 Instructions in the text

Usage instructions in the document follow a general structure that is complete in itself. The required action is indicated by an individual step or multi-part action steps.

Individual action step

A horizontal, solid triangle indicates the only step in an action.

- ▶ This is an individual action step.

Sequence of multi-part action steps

The numerical list indicates an action with multiple necessary steps.

1. Step 1
2. Step 2
3. ...

1.3.2 Pictographs

Pictographs used in the document indicate useful information.



Note



Tip

1.3.3 Stickers on product

This section describes all the stickers on the product along with their meanings.

	<p>Rating plate (example) The rating plate is located on the cover of the electronics.</p>
	<p>Warranty seal The product is sealed ex factory. Damaging or removing a warranty seal results in loss of the warranty.</p>
	<p>Warning of hot surfaces This sticker warns of injuries caused by high temperatures as a result of contact without protection during operation.</p>
	<p>Operating instructions note This sticker indicates that this operating instructions must be read before performing any tasks.</p>

Tbl. 2: Stickers on product

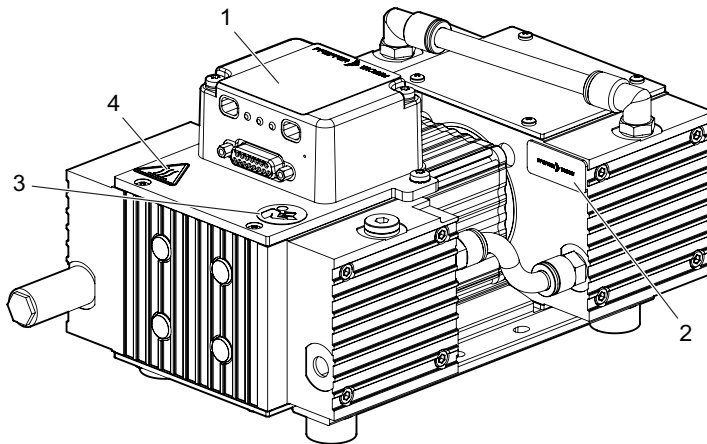

Fig. 1: Position of the stickers on the product

- | | |
|--------------------------------------|-------------------------------|
| 1 Rating plate of the diaphragm pump | 3 Operating instructions note |
| 2 Warranty seal (4×) | 4 Warning of hot surfaces |

1.3.4 Abbreviations

Abbreviation	Meaning in this document
DC	Direct current
DN	Nominal diameter (diamètre nominal)
f	Rotation speed value of a vacuum pump (frequency, in rpm or Hz)
LED	Light emitting diode
MVP	Diaphragm vacuum pump
MSL	Mean sea level
[P:xxx]	Electronic drive unit control parameters. Printed in bold as a three-digit number in square brackets. Frequently displayed in conjunction with a short description. Example: [P:312] software version
PE	Protective earth (earthed conductor)
T	Temperature in °C
TC	Turbopump electronic drive unit (turbo controller)
TPS	Voltage supply (turbo power supply)

Tbl. 3: Abbreviations used in this document

2 Safety

2.1 General safety information

The following 4 risk levels and 1 information level are taken into account in this document.

DANGER

Immediately pending danger

Indicates an immediately pending danger that will result in death or serious injury if not observed.

- ▶ Instructions to avoid the danger situation

WARNING

Potential pending danger

Indicates a pending danger that could result in death or serious injury if not observed.

- ▶ Instructions to avoid the danger situation

CAUTION

Potential pending danger

Indicates a pending danger that could result in minor injuries if not observed.

- ▶ Instructions to avoid the danger situation

NOTICE

Danger of damage to property

Is used to highlight actions that are not associated with personal injury.

- ▶ Instructions to avoid damage to property



Notes, tips or examples indicate important information about the product or about this document.

2.2 Safety instructions

All safety instructions in this document are based on the results of the risk assessment carried out in accordance with Machinery Directive 2006/42/EC Annex I and EN ISO 12100 Section 5. As far as applicable, all unit life cycle phases have been considered.

Risks during transport

WARNING

Danger of serious injury due to falling objects

Due to falling objects there is a risk of injuries to limbs through to broken bones.

- ▶ Take particular care and pay special attention when transporting products manually.
- ▶ Do not stack the products.
- ▶ Wear protective equipment, e.g. safety shoes.

Risks during installation

⚠ DANGER

Danger to life from electric shock

Power supply packs that are not specified or are not approved will lead to severe injury to death.

- ▶ Make sure that the power supply pack meets the requirements for double isolation between mains input voltage and output voltage, in accordance with IEC 61010-1 IEC 60950-1 and IEC 62368-1.
- ▶ Make sure that the power supply pack meets the requirements in accordance with IEC 61010-1 IEC 60950-1 and IEC 62368-1.
- ▶ Where possible, use original power supply packs or only power supply packs that correspond with the applicable safety regulations.

⚠ DANGER

Danger to life from electric shock

When establishing the voltages that exceed the specified safety extra-low voltage (according to IEC 60449 and VDE 0100), the insulating measures will be destroyed. There is a danger to life from electric shock at the communication interfaces.

- ▶ Connect only suitable devices to the bus system.

⚠ WARNING

Risk of injury due to incorrect installation

Dangerous situations may arise from unsafe or incorrect installation.

- ▶ Do not carry out your own conversions or modifications on the unit.
- ▶ Ensure the integration into an Emergency Off safety circuit.

⚠ CAUTION

Danger of injury from bursting as a result of high pressure in the exhaust line

Faulty or inadequate exhaust pipes lead to dangerous situations, e.g. increased exhaust pressure. There is a danger of bursting. Injuries caused by flying fragments, the escaping of high pressure, and damage to the unit cannot be excluded.

- ▶ Route the exhaust line without shut-off units.
- ▶ Observe the permissible pressures and pressure differentials for the product.
- ▶ Check the function of the exhaust line on a regular basis.

Risks during operation

⚠ WARNING

Danger of poisoning due to toxic process media escaping from the exhaust pipe

During operation with no exhaust line, the vacuum pump allows exhaust gases and vapors to escape freely into the air. There is a risk of injury and fatality due to poisoning in processes with toxic process media.

- ▶ Observe the pertinent regulations for handling toxic process media.
- ▶ Safely purge toxic process media via an exhaust line.
- ▶ Use appropriate filter equipment to separate toxic process media.

⚠ CAUTION

Danger of burns on hot surfaces

Depending on the operating and ambient conditions, the surface temperature of the vacuum pump can increase to above 70 °C.

- ▶ Provide suitable touch protection.

Risks during maintenance, decommissioning and in event of malfunctions

WARNING

Health hazard through poisoning from toxic contaminated components or devices

Toxic process media result in contamination of devices or parts of them. During maintenance work, there is a risk to health from contact with these poisonous substances. Illegal disposal of toxic substances causes environmental damage.

- ▶ Take suitable safety precautions and prevent health hazards or environmental pollution by toxic process media.
- ▶ Decontaminate affected parts before carrying out maintenance work.
- ▶ Wear protective equipment.

CAUTION

Danger of injury from moving parts

After a power failure or a standstill as a result of overheating, the motor restarts automatically. There is a risk of injury to fingers and hands if they enter the operating range of rotating parts.

- ▶ Safely disconnect motor from the mains.
- ▶ Secure the motor against reactivation.
- ▶ Dismantle the vacuum pump for inspection, away from the system if necessary.

CAUTION

Danger of burns on hot surfaces

In the event of a fault, the surface temperature of the vacuum pump can increase to above 105 °C.

- ▶ Allow the vacuum pump to cool down before carrying out any work.
- ▶ Wear personal protective equipment if necessary.

Risks during disposal

WARNING

Health hazard through poisoning from toxic contaminated components or devices

Toxic process media result in contamination of devices or parts of them. During maintenance work, there is a risk to health from contact with these poisonous substances. Illegal disposal of toxic substances causes environmental damage.

- ▶ Take suitable safety precautions and prevent health hazards or environmental pollution by toxic process media.
- ▶ Decontaminate affected parts before carrying out maintenance work.
- ▶ Wear protective equipment.

2.3 Safety precautions

DANGER

Danger to life from electric shock

Power supply packs that are not specified or are not approved will lead to severe injury to death.

- ▶ Make sure that the power supply pack meets the requirements for double isolation between mains input voltage and output voltage, in accordance with IEC 61010-1 IEC 60950-1 and IEC 62368-1.
- ▶ Make sure that the power supply pack meets the requirements in accordance with IEC 61010-1 IEC 60950-1 and IEC 62368-1.
- ▶ Where possible, use original power supply packs or only power supply packs that correspond with the applicable safety regulations.



Duty to provide information on potential dangers

The product holder or user is obliged to make all operating personnel aware of dangers posed by this product.

Every person who is involved in the installation, operation or maintenance of the product must read, understand and adhere to the safety-related parts of this document.



Infringement of conformity due to modifications to the product

The Declaration of Conformity from the manufacturer is no longer valid if the operator changes the original product or installs additional equipment.

- Following the installation into a system, the operator is required to check and re-evaluate the conformity of the overall system in the context of the relevant European Directives, before commissioning that system.

General safety precautions

- ▶ Prevent process gases and their reaction and ancillary products that are harmful to health and the environmental from escaping, or dispose of these according to the applicable regulations.
- ▶ Avoid contact with process gases that are harmful to health and if required, wear personal protective clothing.
- ▶ Check the media compatibility of parts carrying media.
- ▶ Observe all applicable safety and accident prevention regulations.
- ▶ Check that all safety measures are observed at regular intervals.
- ▶ Do not expose body parts to the vacuum.
- ▶ Never disconnect plug connections during operation.
- ▶ Never fill or operate the unit with cleaning agents or cleaning agent residues.
- ▶ Do not carry out your own conversions or modifications on the unit.
- ▶ Observe the unit protection degree prior to installation or operation in other environments.
- ▶ Provide suitable touch protection, if the surface temperature exceeds 70°C.
- ▶ Keep lines and cables away from hot surfaces.
- ▶ Before returning the vacuum pump, observe the notes in the chapter Service solutions.

2.4 Limits of use of the product

Installation location	Interiors, protected against the accumulation of dust and weather influences, in a non-explosive, dry environment
Protection degree IEC 60529	IP 20
Protection degree UL 50E	NEMA type 1
Installation altitude	max. 2000 m above sea level ¹⁾
Ambient temperature	+5 °C to +40 °C
Permissible intake temperature of medium to be pumped	+5 °C to +40 °C
Relative air humidity	80% at T ≤ 31 °C, to max. 50% at T ≤ 40 °C
Degree of contamination	2

Tbl. 4: Permissible ambient conditions

2.5 Proper use

- ▶ Use the vacuum pump for vacuum generation only.
- ▶ Adhere to the installation, commissioning, operating, and maintenance instructions.
- ▶ Use only accessory parts recommended by Pfeiffer Vacuum.

1) at an installation location above 1000 meters above sea level, there is a risk of insufficient cooling. If necessary, take measures according to Directive DIN EN 61010.

2.6 Foreseeable improper use

Improper use of the product invalidates all warranty and liability claims. Any use that is counter to the purpose of the product, whether intentional or unintentional, is regarded as improper use; in particular:

- Pumping of corrosive media
- Pumping explosive media
- Pumping radioactive or volatile media
- Pumping of gases that contain contamination such as particles, dust, or condensate
- Pumping of fluids
- Pumping FKM-solubilizing media
- Pumping vapors from combustible liquids
- Pumping pressurized media (> atmospheric pressure)
- Pumping media that can condense or cause adhering deposits to form in the suction chamber
- Using the vacuum pump outside the specified range of application
- Using the vacuum pump below ground
- Using the vacuum pump to generate pressure
- Use of the vacuum pump in systems in which sporadic loads and vibrations or periodic forces act on the unit
- Using the vacuum pump in strong electrical, magnetic, or electromagnetic fields
- Connecting to vacuum pumps and units that are not designed for this purpose according to their operating instructions
- Connecting to units with exposed live parts
- Connecting to sockets without earthing contact
- Use of pipes to lift the vacuum pump
- Use of accessories or spare parts not listed in these instructions
- Using the vacuum pump as a climbing aid
- Using the connection lines between the diaphragm heads as carrying handles
- Using the pump in ambient conditions that do not meet the specified IP protection degree limits

2.7 Personnel qualification

The work described in this document may only be carried out by persons who have appropriate professional qualifications and the necessary experience or who have completed the necessary training as provided by Pfeiffer Vacuum.

Training people

1. Train the technical personnel on the product.
2. Only let personnel to be trained work with and on the product when under the supervision of trained personnel.
3. Only allow trained technical personnel to work with the product.
4. Before starting work, make sure that the commissioned personnel have read and understood these operating instructions and all applicable documents, in particular the safety, maintenance and repair information.

2.7.1 Ensuring personnel qualification

Specialist for mechanical work

Only a trained specialist may carry out mechanical work. Within the meaning of this document, specialists are people responsible for construction, mechanical installation, troubleshooting and maintenance of the product, and who have the following qualifications:

- Qualification in the mechanical field in accordance with nationally applicable regulations
- Knowledge of this documentation

Specialist for electrotechnical work

Only a trained electrician may carry out electrical engineering work. Within the meaning of this document, electricians are people responsible for electrical installation, commissioning, troubleshooting, and maintenance of the product, and who have the following qualifications:

- Qualification in the electrical engineering field in accordance with nationally applicable regulations
- Knowledge of this documentation

In addition, these individuals must be familiar with applicable safety regulations and laws, as well as the other standards, guidelines, and laws referred to in this documentation. The above individuals must

have an explicitly granted operational authorization to commission, program, configure, mark, and earth devices, systems, and circuits in accordance with safety technology standards.

Trained individuals

Only adequately trained individuals may carry out all works in other transport, storage, operation and disposal fields. Such training must ensure that individuals are capable of carrying out the required activities and work steps safely and properly.

2.7.2 Personnel qualification for maintenance and repair



Advanced training courses

Pfeiffer Vacuum offers advanced training courses to maintenance levels 2 and 3.

Adequately trained individuals are:

- **Maintenance level 1**
 - Customer (trained specialist)
- **Maintenance level 2**
 - Customer with technical education
 - Pfeiffer Vacuum service technician
- **Maintenance level 3**
 - Customer with Pfeiffer Vacuum service training
 - Pfeiffer Vacuum service technician

2.7.3 Advanced training with Pfeiffer Vacuum

For optimal and trouble-free use of this product, Pfeiffer Vacuum offers a comprehensive range of courses and technical trainings.

For more information, please contact [Pfeiffer Vacuum technical training](#).

3 Product description

3.1 Function

Diaphragm pumps are dry compressing displacement pumps. The movement of diaphragms generates a periodic change of the suction chamber volume. The gas flow causes the valves to open and close automatically. The pump unit is directly connected to the drive motor.

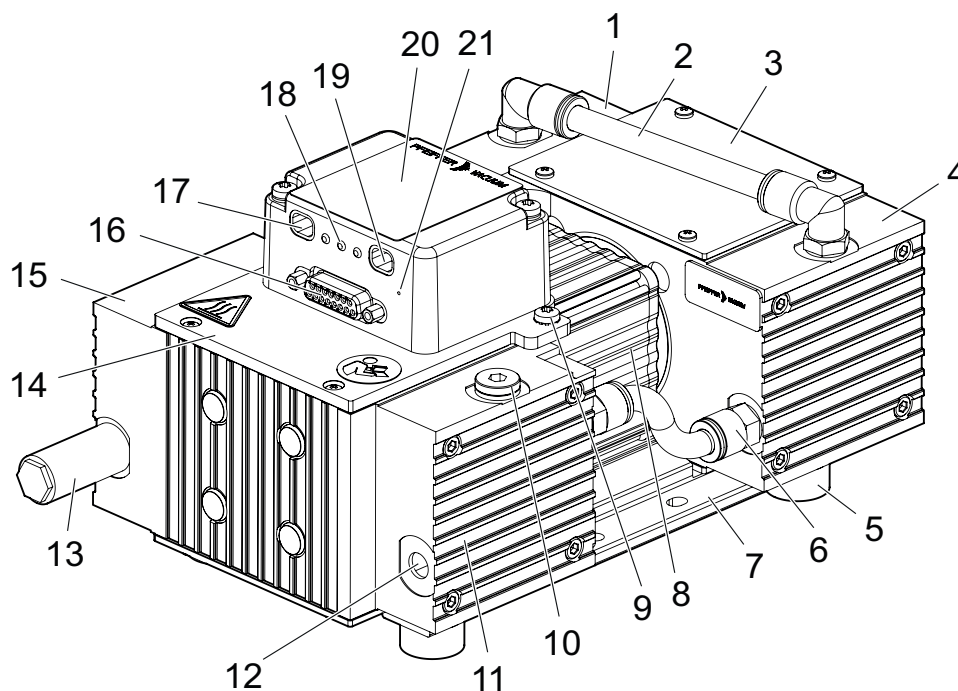

Fig. 2: Diaphragm pump design

1	Diaphragm head 3	12	Vacuum connection, 1/8" thread
2	Interhead connection with hose connection	13	Exhaust with silencer
3	Cover	14	Cover
4	Diaphragm head 2	15	Diaphragm head 4
5	Rubber foot	16	"remote" connection
6	Interhead connection with hose connection	17	Accessory connection C
7	Base plate	18	3 LEDs for operating mode display
8	Motor	19	Accessory connection D
9	Ground terminal	20	Electronic drive unit
10	Locking screw ²⁾	21	Microbutton
11	Diaphragm head 1		

3.1.1 Actuator

The diaphragm pump forms a compact unit with the electronic drive unit. The integrated electronic drive unit permits the control and monitoring of pumping functions via the "remote" interface using a Pfeiffer Vacuum control unit.

3.1.2 Pumping system

The diaphragm pump has 4 diaphragm heads and 4 pumping stages.

3.1.3 Cooling

The diaphragm pump is convection-cooled and does not have its own fan.

²⁾ Remove the locking screw only if you want to mount the optional gas ballast valve or the flushing gas nozzle from the accessories.



3.1.4 Gas ballast

An optional gas ballast system serves the controlled supply of ambient air or inert gas into the suction chamber. Gas ballast supports the reduction of condensate accumulating in the pumping system.

3.1.5 Pressure sensor

The retrofittable RPT 010 digital pressure sensor with piezo/Pirani sensor measures the intake pressure and extends the functionality of the vacuum pump.

3.2 Connections

Connection	Description
	remote D-sub socket with 15 pins for the connection and configuration of a remote control
	Accessory connection 2 connecting sockets with AccessLink for the operation of suitable Pfeiffer Vacuum accessory devices

Tbl. 5: Connection description of the electronic drive unit

3.3 Identifying product

- ▶ To ensure clear identification of the product when communicating with Pfeiffer Vacuum, always keep all of the information on the rating plate to hand.
- ▶ Learn about certifications through test seals on the product or at www.tuev-sued.de.

3.4 Scope of delivery

- Vacuum pump with integrated electronic drive unit
- Silencer
- Operating instructions
- Blind plug on the vacuum connection

4 Transportation and Storage

4.1 Transporting the vacuum pump

WARNING

Danger of serious injury due to falling objects

Due to falling objects there is a risk of injuries to limbs through to broken bones.

- ▶ Take particular care and pay special attention when transporting products manually.
- ▶ Do not stack the products.
- ▶ Wear protective equipment, e.g. safety shoes.



Packing

We recommend keeping the transport packaging and original protective cover.

Safe transport of the product

- ▶ Observe the weight specified on the packaging.
- ▶ Where possible, always transport or ship the product in the original packaging.
- ▶ Always place the product on an adequately sized, level surface.

Transporting the vacuum pump without its packaging

1. Unpack the vacuum pump.
2. To protect the inside of the pump, leave the blind plugs on the vacuum connection during transport.
3. Lift the vacuum pump on both front sides.
4. Lift the vacuum pump out of the transport packaging.
5. Make sure that no forces are acting on the piping system.
6. Always place the vacuum pump on an adequately sized, level surface.

4.2 Storing vacuum pump



Packing

We recommend storing the product in its original packaging.

Safe storing vacuum pump

- ▶ Seal the vacuum connection with the blind plug.
- ▶ Store the vacuum pump only in dry, dust-free rooms, within the specified ambient conditions.
- ▶ In rooms with humid or aggressive atmospheres: Hermetically seal the vacuum pump together with a drying agent in a plastic bag.

5 Installation

5.1 Installing the vacuum pump

Procedure

- ▶ Place the vacuum pump on a flat, horizontal surface.
- ▶ For stationary installation, screw the vacuum pump direct to the mounting surface.
 - Dismantle the base plate for this.
- ▶ When installing the pump in a closed housing, ensure adequate air circulation.
- ▶ Keep the specifications on the motor rating plate visible and freely accessible.

5.2 Connecting the vacuum side

NOTICE

Property damage from contaminated gases

Pumping gases that contain contamination damages the vacuum pump.

- ▶ Use suitable filters or separators from the Pfeiffer Vacuum range of accessories, to protect the vacuum pump.



Installation and operation of accessories

Pfeiffer Vacuum offers a series of special, compatible accessories for its diaphragm pumps.

- Information and ordering options for approved [accessories](#) can be found online.
- Described accessories are not included in the shipment.



Preventing throttling losses

Using the shortest possible vacuum connection lines with large nominal diameter prevents pressure losses.



Condensate separator

Pfeiffer Vacuum recommends the installation of a condensate separator in case vapors are formed from moisture during evacuation.

Procedure

1. Remove the blind plug from the vacuum connection.
2. Establish the shortest possible connection between vacuum pump and vacuum chamber.
3. Choose a minimum vacuum line diameter equal to the nominal diameter of the vacuum connection.
4. Depending on the pump type, use PVC or metallic hoses with flange connections from the [Pfeiffer Vacuum component shop](#).
5. Connect the vacuum pump to the vacuum system using the vacuum connection.

5.3 Connect exhaust side

⚠ WARNING

Danger to life from poisoning where toxic process gases leak with no exhaust line

During normal operation, the vacuum pump expels exhaust gases and vapors freely into the air. In processes involving toxic media, there is a risk of injury and danger to life due to poisoning.

- ▶ Observe the relevant regulations for handling toxic substances.
- ▶ Safely purge toxic process gases via an exhaust line.

⚠ CAUTION**Danger of injury from bursting as a result of high pressure in the exhaust line**

Faulty or inadequate exhaust pipes lead to dangerous situations, e.g. increased exhaust pressure. There is a danger of bursting. Injuries caused by flying fragments, the escaping of high pressure, and damage to the unit cannot be excluded.

- ▶ Route the exhaust line without shut-off units.
- ▶ Observe the permissible pressures and pressure differentials for the product.
- ▶ Check the function of the exhaust line on a regular basis.

⚠ CAUTION**Health hazard from increased noise emission**

Operation without silencer leads to higher noise emissions. Remaining in the close proximity of the vacuum pump for a sustained period of time may cause hearing damage.

- ▶ Install a suitable exhaust line.
- ▶ Wear hearing protection.

**Condensate separator**

Pfeiffer Vacuum recommends installing a condensate separator, with condensate drain at the lowest point of the exhaust line.

Procedure

1. Check the installed silencer for free passage.
2. Choose a minimum exhaust line diameter equal to the nominal diameter of the connection flange.
3. Depending on the pump type, use PVC or metallic hoses with flange connections from the [Pfeiffer Vacuum component shop](#).
4. Option: In case of higher gas throughputs, mount an exhaust line.
5. Route the piping downwards from the vacuum pump, to prevent condensate return.
6. Support or suspend the piping to the vacuum pump so that no piping system forces act on the vacuum pump.

5.4 Establishing the electric connection

⚠ WARNING**Risk of injury due to incorrect installation**

Dangerous situations may arise from unsafe or incorrect installation.

- ▶ Do not carry out your own conversions or modifications on the unit.
- ▶ Ensure the integration into an Emergency Off safety circuit.

5.4.1 Grounding vacuum pump

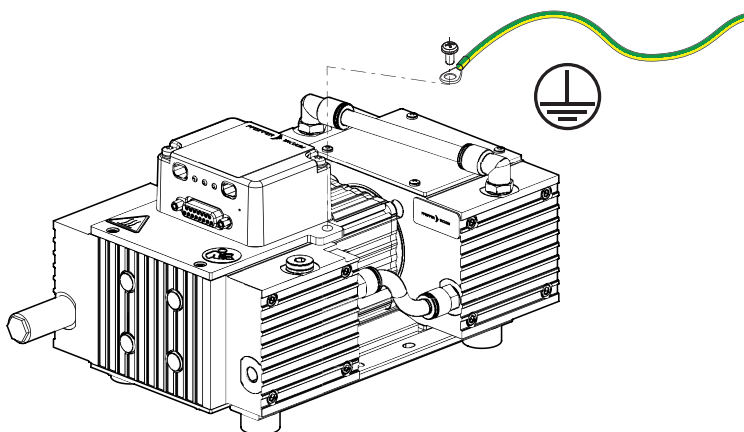

Fig. 3: Connecting grounding cable

Procedure

1. Use a suitable grounding cable to divert applicative interferences.
2. Route the connection in accordance with locally applicable provisions.
3. On the vacuum pump, use the designated ground terminal on the fixing plate (M4 female thread).

5.4.2 Establishing electric connection

⚠ DANGER

Danger to life from electric shock

Power supply packs that are not specified or are not approved will lead to severe injury to death.

- ▶ Make sure that the power supply pack meets the requirements for double isolation between mains input voltage and output voltage, in accordance with IEC 61010-1 IEC 60950-1 and IEC 62368-1.
- ▶ Make sure that the power supply pack meets the requirements in accordance with IEC 61010-1 IEC 60950-1 and IEC 62368-1.
- ▶ Where possible, use original power supply packs or only power supply packs that correspond with the applicable safety regulations.

Original power supply packs (e.g. TPS 110) and connection cables are available for the electronic drive unit supply voltage.

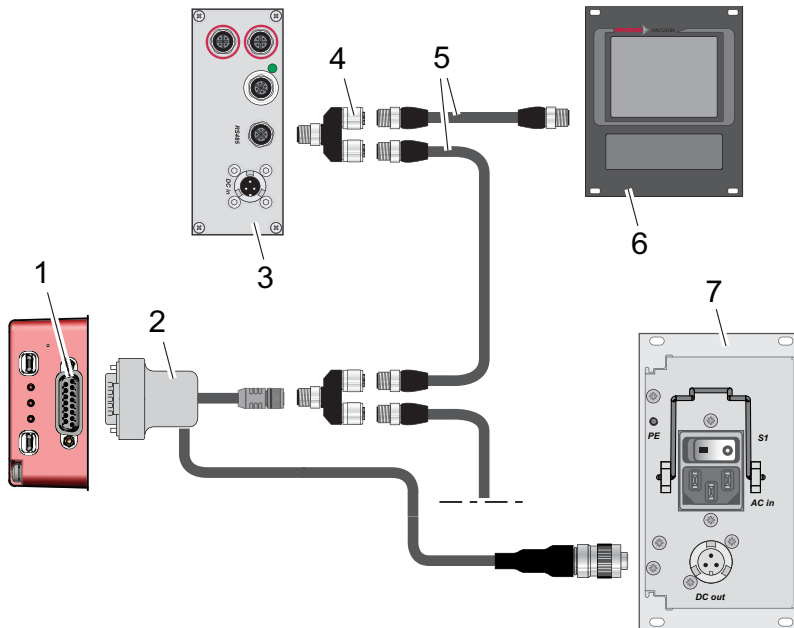

Fig. 4: Connection with turbopump, power supply pack and controller

- | | |
|--|-----------------------|
| 1 "Remote" connection on MVP electronic drive unit | 5 Extension cable M12 |
| 2 Connection cable for power supply pack with RS-485 interface
or
Connection cable for power supply pack and turbopump | 6 Control unit |
| 3 Turbopump electronic drive unit (TC) | 7 Power supply pack |
| 4 Y-distributor M12 for RS-485 interface | |

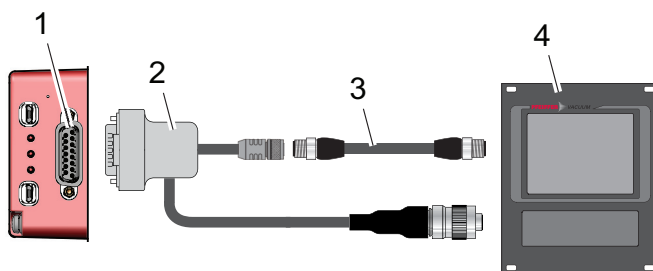

Fig. 5: Connection to control unit with integrated power supply pack

- | | |
|---|---------------------------------------|
| 1 "Remote" connection on MVP electronic drive unit | 3 Extension cable M12 |
| 2 Connection cable for control unit with RS-485 interface | 4 Control unit with power supply pack |

Connecting MVP electronic drive unit

- ▶ Ensure the correct supply voltage.
- ▶ Make sure that the power supply pack main switch is off prior to connection.
- ▶ Use a suitable connection cable from the Pfeiffer Vacuum accessories range.
- ▶ Plug the 15-pin connection cable plug into the "remote" connection on the MVP electronic drive unit and secure it.
- ▶ Insert the connection cable into the connection "DC out" on the power supply pack and close the bayonet lock.
- ▶ **If you are using a Pfeiffer Vacuum control unit:** Connect the "RS-485" connector to the control unit using a suitable extension cable.

6 Interfaces

6.1 "Remote" interface

NOTICE

Property damage on the electronics

Separating all plug-and-socket connections within the bus system with voltage supply switched on may lead to the destruction of electronic components.

- ▶ Always disconnect the voltage supply before removing the connecting plug.
- ▶ After switching off the power supply pack, wait until the residual load has dispersed completely before disconnecting the plug-and-socket connection.

NOTICE

Impairment of electrical connections caused by external disruptive influences

External interference caused by electromagnetic emissions causes malfunctions.

- ▶ A screened cable should be used due to the electromagnetic compatibility (EMC).
- ▶ Connect the screening to the connector housings on both sides.

The 15-pin sub-D connection with the "remote" designation offers the possibility to operate the electronic drive unit via remote control. The following specifications are the factory settings for the electronic drive unit.

Configuring "remote" interface

- ▶ Utilize the screened plug and cable.
- ▶ Configure the inputs and outputs via the Pfeiffer Vacuum parameter set.

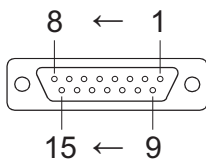

Fig. 6: Pins of the D-Sub socket, 15-pin

Pin	Function	Description, factory setting
1	+24 VDC input	Voltage supply for drive and interface
2	DI access request	V+: Control via DIs, --> GND/open: Control unlocked
3	DI1	V+: Rotation speed setting mode, --> GND/open: no rotation speed setting mode
4	DI2	Only valid for vacuum pumps with a solenoid valve; the following then applies: V+: Valve released, --> GND/open: Valve closed
5	DI pumping station	V+: Vacuum pump on, --> GND/open: Vacuum pump off
6	DI standby	V+: standby, --> GND/open: no standby
7	V+	24 V output
8	DO1	GND: Error, V+: no error
9	DO2	GND: Vacuum pump off, V+: Vacuum pump on
10	n.c.	
11	n.c.	
12	n.c.	
13	RS-485	D+

Pin	Function	Description, factory setting
14	RS-485	D-
15	Ground (GND)	Ground connection of the voltage supply; reference ground for all digital inputs and outputs

Tbl. 6: Pin assignment of the D-Sub socket, 15-pin

6.1.1 Voltage supply

Input/pin 1

The electrical connection is made using a connection cable from the Pfeiffer Vacuum accessory range or, by the customer, at pin 1 and pin 15.

+24 V DC* output/pin 7

A connection with +24 V DC to pin 7 (active high) activates inputs 2 to 6. Alternatively, they can be activated via an external PLC. "PLC High level" activates and "PLC Low level" deactivates the functions.

- PLC High level: +13 V to +33 V
- PLC Low level: -33 V to +7 V
- Ri: 7 kΩ
- $I_{\max} < 200$ mA (with RS-485, where present)

6.1.2 Inputs

The digital inputs switch various electronic drive unit functions. Inputs are assigned with functions ex-factory. You can configure them via the RS-485 interface and the Pfeiffer Vacuum parameter set.

Input DI remote priority/pin 2

V+: The "remote" connection has operating priority over all other control sources.

open: Remote priority "inactive"

Input DI1 rotation speed setting mode/pin 3

V+: Rotation speed setting mode "active"

open: Rotation speed setting mode "inactive"

Input DI pumping station/pin 5

V+:	Vacuum pump on Control of all components connected and malfunction acknowledgement.
open:	Vacuum pump off

Input DI stand-by/pin 6

V+:	Stand-by activated The stand-by speed can be selected in the range 30 to 100% of the nominal speed.
GND/open:	Stand-by off

6.1.3 Outputs

The digital outputs have a maximum load limit of 24 V/50 mA per output.

V+:	No error After applying the voltage supply, the digital output DO1 permanently outputs V+ meaning which means "no error".
GND	Error "Active low" signifies "Error" (common error message).

Tbl. 7: Output DO1/pin 8

V+:	Vacuum pump on "Active high" means "Vacuum pump on" and rotates at set rotation speed. Example: use the signal for the message vacuum pump "Ready for operation".
GND	Vacuum pump off

Tbl. 8: Output DO2/pin 9

6.1.4 RS-485

Connecting RS-485 via D-Sub

- ▶ Connect a Pfeiffer Vacuum control unit or an external PC via pin 13 and pin 14 at the D-Sub connection of the electronic drive unit.

6.2 Interface RS-485

⚠ DANGER

Danger to life from electric shock

When establishing the voltages that exceed the specified safety extra-low voltage (according to IEC 60449 and VDE 0100), the insulating measures will be destroyed. There is a danger to life from electric shock at the communication interfaces.

- ▶ Connect only suitable devices to the bus system.

The interface designated "RS-485" is intended for connecting a Pfeiffer Vacuum control unit or an external PC. The connections are galvanically safe and are isolated from the maximum supply voltage for the electronic drive unit.

Designation	Value
Serial interface	RS-485
Baud rate	9600 Baud
Data word length	8 bit
Parity	none (no parity)
Start bits	1
Stop bits	1

Tbl. 9: Features of the RS-485 interface

Connecting Pfeiffer Vacuum control units or a PC

- ▶ Use the connection cable from the scope of delivery of the control unit or from the [Pfeiffer Vacuum accessories](#).
- ▶ Connect a control unit to the RS-485 interface.
- ▶ Connect a PC via the USB/RS-485 converter.

Networking as RS-485 bus

The group address for the electronic drive unit is **902**.

1. Install the devices according to the specification for RS-485 interfaces.
2. Make sure that all devices connected to the bus have different RS-485 device addresses **[P:797]**.
3. Connect all devices with RS-485 D+ and RS-485 D- to the bus.

6.3 Cross-linking via RS-485 connection

⚠ DANGER

Danger to life from electric shock

When establishing the voltages that exceed the specified safety extra-low voltage (according to IEC 60449 and VDE 0100), the insulating measures will be destroyed. There is a danger to life from electric shock at the communication interfaces.

- ▶ Connect only suitable devices to the bus system.

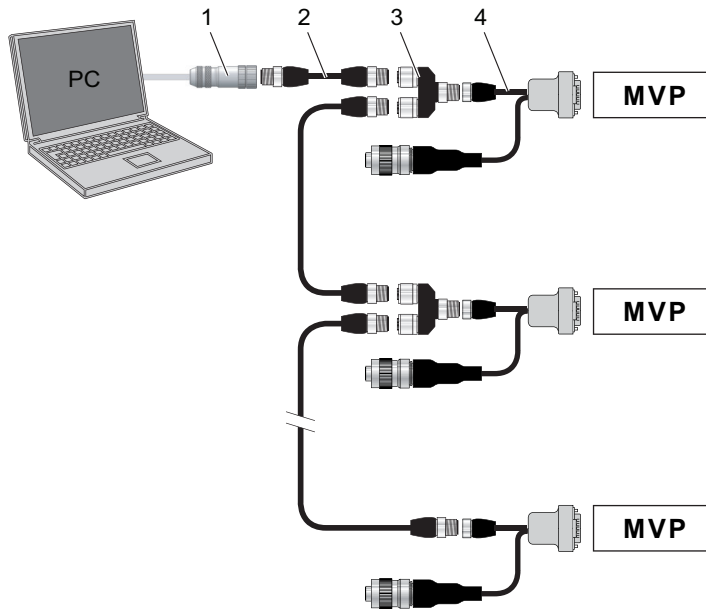

Fig. 7: Cross-linking via RS-485 interface

- 1 USB RS-485 converter
- 2 M12 to M12 extension cable
- 3 Y-connector for RS-485
- 4 Connection cable with RS-485

6.4 Pfeiffer Vacuum protocol for RS-485 interface

6.4.1 Telegram frame

The telegram frame of the Pfeiffer Vacuum protocol contains only ASCII code characters [32; 127], the exception being the end character of the telegram C_R . Basically, a host (e.g. a PC) sends a telegram, which a device (e.g. electronic drive unit or gauge) responds to.

a2	a1	a0	*	0	n2	n1	n0	l1	l0	dn	...	d0	c2	c1	c0	C_R
----	----	----	---	---	----	----	----	----	----	----	-----	----	----	----	----	-------

a2 – a0	Device address
	<ul style="list-style-type: none"> • Individual address of the unit ["001";"255"] • Group address "9xx" for all identical units (no response) • Global address "000" for all units on the bus (no response)
*	Action according to telegram description
n2 – n0	Pfeiffer Vacuum parameter numbers
l1 – l0	Data length dn to d0
dn – d0	Data in the respective data type (see chapter "Data types", page 28).
c2 – c0	Checksum (sum of ASCII values of cells a2 to d0) modulo 256
C_R	carriage return (ASCII 13)

6.4.2 Telegram description

Data query --> ?

a2	a1	a0	0	0	n2	n1	n0	0	2	=	?	c2	c1	c0	C_R
----	----	----	---	---	----	----	----	---	---	---	---	----	----	----	-------

Control command --> !

a2	a1	a0	1	0	n2	n1	n0	l1	l0	dn	...	d0	c2	c1	c0	C_R
----	----	----	---	---	----	----	----	----	----	----	-----	----	----	----	----	-------

Data response / Control command understood -->

a2	a1	a0	1	0	n2	n1	n0	l1	l0	dn	...	d0	c2	c1	c0	C_R
----	----	----	---	---	----	----	----	----	----	----	-----	----	----	----	----	-------

Error message ○ --> ☒

a2	a1	a0	1	0	n2	n1	n0	0	6	N	O	_	D	E	F	c2	c1	c0	c _R
										_	R	A	N	G	E				
										_	L	O	G	I	C				

NO_DEF Parameter number n2–n0 no longer exists
 _RANGE Data dn–d0 outside the permissible range
 _LOGIC Logical access error

6.4.3 Telegram example 1

Data query

Current rotation speed (parameter [P:309], device address: "123")

☒ --> ○ ?	1	2	3	0	0	3	0	9	0	2	=	?	1	1	2	c _R
ASCII	49	50	51	48	48	51	48	57	48	50	61	63	49	49	50	13

Data response: 633 Hz

Current rotation speed (parameter [P:309], device address: "123")

○ --> ☒	1	2	3	1	0	3	0	9	0	6	0	0	0	6	3	3	0	3	7	c _R
ASCII	49	50	51	49	48	51	48	57	48	54	48	48	48	54	51	51	48	51	55	13

6.4.4 Telegram example 2

Control command

Switch on the pumping station (parameter [P:010], device address: "042")

☒ --> ○ !	0	4	2	1	0	0	1	0	0	6	1	1	1	1	1	1	0	2	0	c _R
ASCII	48	52	50	49	48	48	49	48	48	54	49	49	49	49	49	49	48	50	48	13

Control command understood

Switch on the pumping station (parameter [P:010], device address: "042")

○ --> ☒	0	4	2	1	0	0	1	0	0	6	1	1	1	1	1	1	0	2	0	c _R
ASCII	48	52	50	49	48	48	49	48	48	54	49	49	49	49	49	49	48	50	48	13

6.4.5 Data types

No.	Data type	Description	Length l1 – l0	Example
0	boolean_old	Logical value (false/true)	06	000000 is equivalent to false 111111 is equivalent to true
1	u_integer	Positive whole number	06	000000 to 999999
2	u_real	Fixed point number (unsigned)	06	001571 corresponds with 15.71
4	string	Any character string with 6 characters. ASCII codes between 32 and 127	06	TC_110, TM_700
6	boolean_new	Logical value (false/true)	01	0 is equivalent to false 1 is equivalent to true
7	u_short_int	Positive whole number	03	000 to 999

No.	Data type	Description	Length l1 – l0	Example
10	u_expo_new	Positive exponential number. The last of both digits are the exponent with a deduction of 20.	06	100023 is equivalent to $1,0 \cdot 10^3$ 100000 is equivalent to $1,0 \cdot 10^{-20}$
11	string16	Any character string with 16 characters. ASCII codes between 32 and 127	16	BrezelBier&Wurst
12	string8	Any character string with 8 characters. ASCII codes between 32 and 127	08	Example

7 Parameter set

7.1 General

Important settings and function-related characteristics are factory-programmed into the electronic drive unit as parameters. Each parameter has a three-digit number and a description. The parameter can be accessed via Pfeiffer Vacuum control units or externally via RS-485 using Pfeiffer Vacuum protocol. The electronic drive unit is pre-programmed in the factory. This makes a more direct and safe operation of the vacuum pump possible without additional configuration.

The following parameters can be configured for the specific process:

- **[P:026]**: rotation speed setting mode on/off.
- **[P:707]**: specification of the rotation speed setting mode with 30 to 170 % of the nominal rotation speed.
- **[P:002]**: stand-by mode on/off.

#	Three digit number of the parameter
Indicator	Display of parameter description
Description	Brief description of the parameters
Functions	Function description of the parameters
Data type	Type of formatting of the parameter for the use with the Pfeiffer Vacuum protocol
Access type	R (read): Read access; W (write): Write access
Unit	Physical unit of the described variable
min. / max.	Permissible limit values for the entry of a value
default	Factory default pre-setting (partially pump-specific)
	The parameter can be saved persistently in the electronic drive unit

Tbl. 10: Explanation and meaning of the parameters

7.2 Control commands

#	Indicator	Designations	Functions	Data type	Access type	Unit	min.	max.	default	
002	Stand-by	Stand-by	0 = off 1 = on	0	RW		0	1	0	✓
009	ErrorAckn	Malfunction acknowledgement	-	0	W		1	1	-	✓
010	PumpgStatn	Pump	0 = off 1 = on	0	RW		0	1	0	✓
019	Cfg DO2	Output DO2 configuration	1 = No error 2 = Error 5 = Set rotation speed reached 6 = Pump on 9 = "0" 10 = "1" 11 = Remote priority active	7	RW		0	20	5	✓
024	Cfg DO1	Output DO1 configuration	Settings, see [P:019]	7	RW		0	20	1	✓
026	SpdSetMode	Rotation speed setting mode	0 = off 1 = on	7	RW		0	1	0	✓
030	ValveMode	Flushing gas configuration ³⁾	0 = auto 1 = closed 2 = open	7	RW		0	2	0	✓

#	Indicator	Designations	Functions	Data type	Access type	Unit	min.	max.	de-fault	
050	PurgeGas	Flushing gas ⁴⁾	0 = off 1 = on	0	RW		0	1	1	✓
060	CtrlVialnt	Operate via interface	1 = remote 2 = RS-485 4 = PV.can 255 = Interface selection	7	RW		1	255	1	✓
061	IntSelLckd	Interface selection locked	0 = off 1 = on	0	RW		0	1	0	✓
068	Cfg acc C	Configuration accessory connection C ⁵⁾	1 = automatic gas ballast valve 6 = valve permanently closed 7 = valve permanently open	7	RW		1	7	1	✓
069	Cfg acc D	Configuration accessory connection D ⁶⁾	1 = automatic gas ballast valve 6 = valve permanently closed 7 = valve permanently open	7	RW		1	7	1	✓
095	FactoryReset	Factory settings	0 = no 1 = yes, only possible while stationary	0	RW		0	1	0	-

Tbl. 11: Parameter set | Control commands

7.3 Status requests

#	Indicator	Designations	Functions	Data type	Access type	Unit	min.	max.	de-fault	
303	Error code	Error code		4	R					-
309	ActualSpd	Actual rotation speed (Hz)		1	R	Hz				-
310	DrvCurrent	Drive current	Drive current in A	2	R	A	0	9999.99		-
311	OpHrsPump	Pump operating hours		1	R	h				✓
312	Fw version	Software version interface circuit board		4	R					-
313	DrvVoltage	Supply voltage	Voltage in V	2	R	V				-
314	OpHrsElec	Drive electronics operating hours		1	R	h				✓
315	Nominal Spd	Nominal rotation speed (Hz)		1	R	Hz				-
316	DrvPower	Drive power	Output in W	1	R	W				-
326	TempElec	Electronics temperature		1	R	°C	0	9999		-
330	TempPump	Pump temperature		1	R	°C	0	999999		-

3) if available

4) if available









5) Detection through interface

6) Detection through interface

#	Indicator	Designations	Func-tions	Data type	Access type	Unit	min.	max.	de-fault	
349	ElecName	Device name designation		4	R					-
354	HW Version	Hardware version interface circuit board		4	R					-
355	Serial number	Example: 12345678		11	R					-
388	Order number	Example: PK T05 1xx		11	R					-
398	ActualSpd	Actual rotation speed (rpm)		1	R	rpm				--
399	NominalSpd	Nominal rotation speed (rpm)		1	R	rpm				-

Tbl. 12: Parameter set | Status requests

7.4 Reference value inputs

#	Indicator	Designations	Func-tions	Data type	Access type	Unit	min.	max.	de-fault	
707	SpdSVal	Set value in rotation speed setting mode	Set rotation speed as % of nominal rotation speed	2	RW	%	30	170	75	
717	StdbysVal	Rotation speed set value in stand-by operation		2	RW	%	30	100	66.7	
721	SlgVlvTime	Flushing gas specification active		1	RW	s	5	255	60	
739	PrsSn1Name	Name sensor 1		4	R					-
740	Pressure 1	Pressure value 1		10	R	hPa	$1 \cdot 10^{-5}$	1200.0		
742	PrsCorrPi 1	Correction factor 1		2	RW		0.1	8.0	-	
749	PrsSn2Name	Name sensor 2		4	R					-
750	Pressure 2	Pressure value 2		10	R	hPa	$1 \cdot 10^{-5}$	1200.0		
752	PrsCorrPi 2	Correction factor 2		2	RW		0.1	8.0	-	
797	RS485Adr	RS-485 Interface address		1	RW		1	255	2	

Tbl. 13: Parameter set | Reference value inputs

8 Operation

8.1 Commissioning vacuum pump

WARNING

Danger of poisoning due to toxic process media escaping from the exhaust pipe

During operation with no exhaust line, the vacuum pump allows exhaust gases and vapors to escape freely into the air. There is a risk of injury and fatality due to poisoning in processes with toxic process media.

- ▶ Observe the pertinent regulations for handling toxic process media.
- ▶ Safely purge toxic process media via an exhaust line.
- ▶ Use appropriate filter equipment to separate toxic process media.

NOTICE

Vacuum pump damage caused by overpressure

Mixing up the connections causes overpressure overload. The vacuum pump can be started only against max. 1 bar differential pressure between inlet and outlet; otherwise the motor jams and sustains damage.

- ▶ Make sure that the distributor is installed correctly on the diaphragm heads, before connecting the vacuum pump to the vacuum equipment.
- ▶ Before commissioning, make completely sure that the pressure side pressure is below the permissible limit.

Parameter	Name	Designation	Adjustment, setting
[P:707]	SpdSVal	Speed-control operation specification	75 %

Tbl. 14: Factory setting of the electronic drive unit for diaphragm pumps when delivered

Procedure

1. Compare the frequency specifications on the rating plate with the available supply voltage.
2. Check the exhaust connection for free passage (max. permissible pressure: 1100 hPa absolute).
3. Actuate the shut-off units so that the shut-off units open before or at the same time as the vacuum pump starts up.

8.2 Switching on the vacuum pump

When pumping down dry gases, no special precautions are required.

CAUTION

Danger of burns on hot surfaces

Depending on the operating and ambient conditions, the surface temperature of the vacuum pump can increase to above 70 °C.

- ▶ Provide suitable touch protection.



Warm-up time of the vacuum pump

The warm-up time depends on the ambient temperature and takes at least 30 minutes.

Prerequisite

- required cable connections established

Switching on vacuum pump

1. If required, switch the vacuum pump on in each pressure range in one of the 3 possible ways:
 - using a mains switch on the power supply pack with respective bridges on the 15-pin D-Sub socket
 - via a control unit, e.g. OmniControl or PC
 - using the PLC control unit on the 15-pin D-Sub socket
2. Allow the vacuum pump to warm up prior to process start, with the vacuum connection closed.

The vacuum pump achieves the specified throughput and final pressure values once the operating temperature has been reached.

8.3 Configuring connections with Pfeiffer Vacuum parameter set

The electronic drive unit is pre-configured with the factory default basic functions and is ready for operation. For individual requirements, most connections for the electronic drive unit can be configured with the parameter set.

8.3.1 Configuring the digital outputs

Option	Description
1 = No error	active, with trouble-free operation
2 = Error	active, if the error message is active
5 = Set rotation speed reached	active, once the set rotation speed is reached
6 = Pump on	active, if pump on, motor on and no error
9 = always 0	GND for the control of an external device
10 = always 1	V+ for the control of an external device
11 = Remote	active, if the remote priority is active

Tbl. 15: Configure parameters [P:019] and [P:024]

Procedure

- ▶ Perform the configuration according to the table.

8.3.2 Selecting the interfaces

Option [P:060]	Description
1 = remote	Operation via connection "remote"
2 = RS-485	Operation via connection "RS-485"
4 = PV.can	For service purposes only
Option [P:061]	
0 = off	Interface selection can be set via [P:060].
1 = on	Interface selection locked

Tbl. 16: Parameters [P:060] and [P:061]

Procedure

- ▶ Select the interface according to the table.

8.3.3 Configuring accessories

NOTICE

Property damage to third-party electronic devices

The accessory connections on the vacuum pump do not meet any USB standard. The connection assignment does not comply with any standard. Depending on their configuration, the 24 V DC supply voltage may damage or destroy third-party electronic devices, e.g. tablet computer.

- ▶ Do not connect any third-party electronic devices to the accessory connections.
- ▶ Only use the connecting sockets for pump-specific accessories.

Accessory connectors with AccessLink are each used to connect an accessory. The software of the electronic drive unit automatically detects accessories connected to interfaces.

Approved accessories

- Pressure sensor
- Solenoid valve for gas ballast

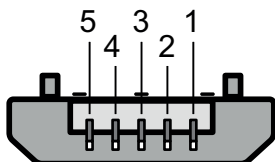

Fig. 8: Accessory connector assignment

- | | |
|---------------------------------|--|
| 1 + 5 V (blue) | 4 + 24 V (depending on software configuration) |
| 2 Sensor RxD / host TxD (white) | 5 GND (black) |
| 3 Sensor TxD / host RxD (green) | |

Configuring accessories

- ▶ Configure connected accessories with parameters **[P:068]** and **[P:069]**, if necessary.
 - The manual configuration overwrites the automatically detected value.

8.4 Operating modes

- Operating without control unit
- Operation via an external control unit
- Operation via RS-485 and Pfeiffer Vacuum control unit or PC

The connection of a Pfeiffer Vacuum control unit permits the controlling of the vacuum pump via the parameters fixed in the electronic drive unit.



Automatic start

After bypassing the contacts at pins 2, 7, 5 on the connecting plug or when using a connection cable with respective bridges and applying the supply voltage, the vacuum pump starts up immediately. Pfeiffer Vacuum recommends switching on the voltage supply immediately before operation.

Operating vacuum pump without controller

1. Connect the respective connecting cable with bridges to the "remote" connection of the electronic drive unit.
2. Provide the current supply for the power supply pack.
3. Switch on the current supply on the power supply pack.

After applying the operating voltage, the vacuum pump carries out a self-test to check the supply voltage. After a successfully completed self-test, the vacuum pump starts.

Operating vacuum pump with external controller

1. Connect a remote control via the "remote" 15-pin D-Sub socket.
2. Control the vacuum pump by means of the "PLC level".

Operating vacuum pump with control unit

1. Observe the operating instructions of the control unit.
2. Connect the respective control unit at the "remote" connection.
3. Switch on the current supply on the power supply pack or on the control unit.
4. Make the desired settings via the RS-485 using the control unit.

8.4.1 Normal operation

The vacuum pump starts in boost mode for max. 5 minutes with the maximum speed. The current is monitored at the same time. If the current is below a threshold value, the speed is controlled down to nominal rotation speed. In case the power input increases again, automatic increase of the speed does not take place. An increase in speed is reached again after vacuum pump stop / start.

Setting the related parameters

1. Set the parameter **[P:002]** to "0".
2. Set the parameter **[P:026]** to "0".
3. Check the set rotation speed (parameter **[P:309]** or **[P:398]**).

8.4.2 Stand-by operation

Pfeiffer Vacuum recommends stand-by operation for the vacuum pump during breaks in processes or production.

- The factory setting is 66.7 % of the nominal speed.
- Stand-by operation has priority over rotation speed setting mode.
- With active stand-by mode, the electronic drive unit reduces the speed of the vacuum pump in the range of **30 to 100%** of the nominal speed.

Activate stand-by rotation speed

1. Set the parameter **[P:717]** to the required value in %.
2. Set the parameter **[P:026]** to "0".
3. Set the parameter **[P:002]** to "1".
4. Check the set rotation speed (parameter **[P:309]** or **[P:398]**).

8.4.3 Speed actuator operation



Permissible rotation speed range of the vacuum pump

Parameterization in rotation speed setting mode is subject to the permissible rotation speed range of the respective vacuum pump. The electronic drive unit regulates automatically to the next valid value.

The set rotation speed is selected via the parameter **[P:707]** in the range **30 to 170 %** of the set rotation speed. As of a speed higher than the set rotation speed (> 100%), increased pump wear is possible.

The rotation speed setting mode has priority over the stand-by mode.

Set the rotation speed setting mode

1. Set the parameter **[P:707]** to the required value in %.
2. Set the parameter **[P:026]** to "1".
3. Query the set rotation speed via parameter **[P:309]** or **[P:398]**.

8.5 Determining effective pressure with correction factors



Gas and vapor mixtures

Process gases are mostly mixtures of gas and vapor. Precise measuring of gas and vapor mixtures is only possible using partial pressure measurement instruments, for example a quadrupole mass spectrometer.

The measurement signal of the pressure sensor depends on the type of gas in the Pirani range. The pre-set correction factor = 1 applies for nitrogen (N₂), oxygen (O₂), dry air, and carbon monoxide (CO).

Gas type	Correction factor (C)
Air, oxygen (O ₂), carbon monoxide (CO), nitrogen (N ₂)	1.0
Hydrogen (H ₂)	0.5
Carbon dioxide (CO ₂)	0.9
Water vapor	0.5
Helium (He)	0.8
Neon (Ne)	1.4
Argon (Ar)	1.7
Krypton (Kr)	2.4

The correction factors provided are mean values.

Gas type	Correction factor (C)
Xenon (Xe)	3.0
Dichlorodifluoromethane (CCl ₂ F ₂ , R12)	0.7

The correction factors provided are mean values.

Tbl. 17: Correction factor for pressure range < 1 hPa

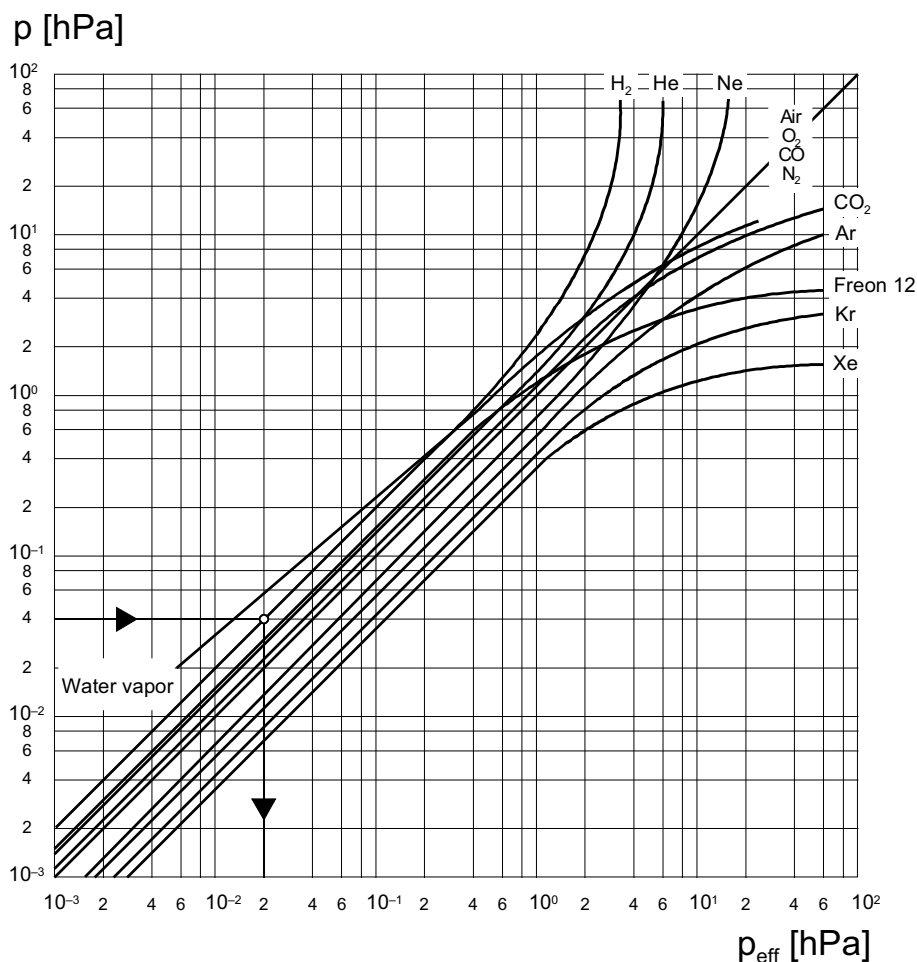

Fig. 9: Displayed pressure

Within the pressure range < 1 hPa, the display is linear.

Set correction factor at electronic drive unit

- ▶ Use [P:742] to enter correction factor and correct displayed measured value.

Alternatively: Calculating pressure for gases other than air

1. Set the correction factor in the electronic drive unit to 1
2. Calculate the effective pressure using the following formula:













$$P_{\text{eff}} = C \times p$$

- P_{eff} = Effective pressure
- C = Correction factor of the gas to be measured
- p = Displayed pressure (gauge calibrated for air)

8.6 Operation monitoring

8.6.1 Operating mode display via LED

LEDs on the electronic drive unit show the basic operating states of the vacuum pump. A differentiated error and warning display is only possible for operation with the Pfeiffer Vacuum control unit or a PC.

LED	Symbol	LED status	Display	Meaning
Green 		Off	—	without current
		On, flashing		"Pumping station OFF", rotation speed ≤ 60 rpm
		On, blinking		"Pumping station OFF", rotation speed > 60 rpm
		On, inverse flashing		"Pumping station ON", set rotation speed not reached
		On, constant		"Pumping station ON", set rotation speed reached Standby on
		On, inverse flashes twice		Selected speed temporarily overwritten by an autospeed mode
Yellow 	△	Off	—	no warning
		On, short-time blinking		Note ⁷⁾
		On, constant		Warning
		On, flickering 1 sec		Confirmation, command acceptance
Red 	⚡	Off	—	No error
		On, constant		Error

Tbl. 18: Behavior and meaning of the LEDS of the electronic drive unit

8.6.2 Temperature monitoring

If threshold values are exceeded, output signals from temperature sensors allow the vacuum pump to be switched to a safe state. Depending on the type, temperature thresholds for warning and malfunction messages are stored immutably in the electronic drive unit. For information purposes, various status requests are set up in the parameter set.

- With a pump temperature $T > 75\text{ °C}$, the electronic drive unit reduces the motor to the nominal rotation speed to avoid overheating of the vacuum pump.
 - "Warning" is displayed.
 - After cooling down ($< 72\text{ °C}$), the vacuum pump starts to run at set rotation speed.
- If the error threshold for excess temperature $T > 85\text{ °C}$ is exceeded, the vacuum pump switches off immediately.
 - A "Malfunction message" is displayed.

Acknowledging error

1. Remove the cause of the malfunction.
2. Switch the vacuum pump off and back on.

Acknowledging error alternatively via control unit

- ▶ Set the parameter [P:010] to the value "0/1".
- ▶ Reset the error message with parameter [P:009] or via the control unit.
- ▶ Switch the running vacuum pump off and back on via the control unit.

8.7 Switching off the vacuum pump

Procedure

1. Allow the vacuum pump to run on for 5 to 10 minutes with the vacuum connection open to allow any condensate that may be present to be removed from the vacuum pump.
2. If required, switch the vacuum pump off in each pressure range.
3. Disconnect the voltage supply on the power supply pack.

7) Regularly check the performance data of the vacuum pump.

9 Maintenance

9.1 Maintenance instructions

WARNING

Health hazard through poisoning from toxic contaminated components or devices

Toxic process media result in contamination of devices or parts of them. During maintenance work, there is a risk to health from contact with these poisonous substances. Illegal disposal of toxic substances causes environmental damage.

- ▶ Take suitable safety precautions and prevent health hazards or environmental pollution by toxic process media.
- ▶ Decontaminate affected parts before carrying out maintenance work.
- ▶ Wear protective equipment.

CAUTION

Danger of injury from moving parts

After a power failure or a standstill as a result of overheating, the motor restarts automatically. There is a risk of injury to fingers and hands if they enter the operating range of rotating parts.

- ▶ Safely disconnect motor from the mains.
- ▶ Secure the motor against reactivation.
- ▶ Dismantle the vacuum pump for inspection, away from the system if necessary.

NOTICE

Damage caused by unsuitable cleaning agents

Unsuitable cleaning agents damage pump parts.

- ▶ Use only approved cleaning agents to clean pump parts.
- ▶ Use only a clean dry cloth to clean the diaphragms and valves.
- ▶ Do not use any alcohol or other cleaning agents to clean the diaphragms and valves.

NOTICE

Danger of property damage from improper maintenance

Unprofessional work on the vacuum pump will lead to damage for which Pfeiffer Vacuum accepts no liability.

- ▶ We recommend taking advantage of our service training offering.
- ▶ When ordering spare parts, specify the information on the nameplate.

The following section relates to the tasks for cleaning and maintaining the vacuum pump. Valves and diaphragms are wear parts.

Component	Operating hours
Diaphragms	17 500
Valves	17 500

Tbl. 19: Typical service life with normal use

Prerequisites

- Vacuum pump switched off
- Vacuum pump vented from atmospheric pressure
- Vacuum pump cooled

Required materials

- Cloth (clean, lint-free)
- Water or mild soap solution

Servicing the vacuum pump

1. Disconnect the vacuum pump from the voltage supply.
2. Secure the motor against reactivation.
3. Remove any external contamination on the vacuum pump with cloth slightly moistened with water or a mild soap solution.
4. Allow all cleaned parts to dry well.
5. For maintenance work, only dismantle the vacuum pump to the extend needed.
6. Clean the suction chamber, diaphragms, and valves with a dry cloth.
7. Examine the diaphragms and valves for cracks at the latest when the pressure values achieved decrease.

9.2 Checklist for inspection and maintenance



Maintenance frequency and service lives

Maintenance frequency and service lives are process-dependent. Chemical and thermic loads or contamination reduce the recommended reference values.

- Determine the specific service lives during the first operating interval.
- Consult with Pfeiffer Vacuum Service if you wish to reduce the maintenance frequency.



Yellow LED flashing: Checking performance data

The flashing yellow LED indicates that maintenance may be required. Wear and service life are primarily dependent on the application. If the pumping capacity is no longer adequate, we recommend carrying out maintenance.

- Regularly observe the performance data of the vacuum pump.
- Press the microbutton to reset the message.



Maintenance by Pfeiffer Vacuum Service

We recommend that Pfeiffer Vacuum Service carry out maintenance work. If the specified intervals are exceeded, or if maintenance work is carried out improperly, no warranty or liability claims are accepted on the part of Pfeiffer Vacuum. This also applies wherever parts other than original spare parts are used.

Action	Inspection	Maintenance	Required material
Interval	as required; at least once every six months	as required; at least every 2 years	
Check silencer for contamination ⁸⁾	■		
Test vacuum pump optically and acoustically	■		
Read out and analyze pump data ⁹⁾		■	
Clean the vacuum pump		■	
Change the diaphragms and valves		■	Overhaul kit
Change silencer ¹⁰⁾		■	Silencer
Performing a function test		■	
Performing incoming inspection		■	
Clean vacuum pump completely		■	

8) if present

9) DC pumps only

10) if present

Action	Inspection	Maintenance	Required material
Interval	as required; at least once every six months	as required; at least every 2 years	
Change gas ballast filter ¹¹⁾		■	Filter
Replace wear parts		■	Diaphragms, valves, sealing rings, silencers

Tbl. 20: Maintenance intervals

9.3 Change the diaphragms and valves

NOTICE

Property damage from incorrect installation

Change in dead volume due to incorrect installation of the original spacer disks impairs the final vacuum or leads to bearing damage.

- ▶ During disassembly, keep the existing spacer disks separate per installation location.
- ▶ Reinstall the same number of original spacer disks per diaphragm head.

9.3.1 Mounting/removing interconnection hose



IQS plug-and-socket connections

IQS plug-and-socket connections have 2 pressure points: Holding claw and seal. The hose is properly connected when both pressure points are passed.

Prerequisites

- Diaphragm pump switched off
- Voltage supply disconnected
- Diaphragm pump vented to atmospheric pressure
- Diaphragm pump cooled

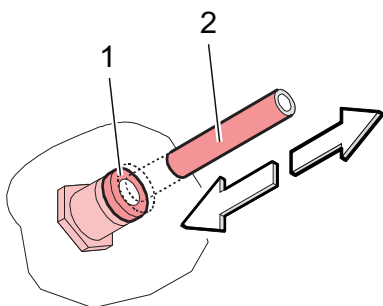

Fig. 10: Mounting/removing interconnection hose

- 1 Release ring 2 Hose

Removing hose

1. Press the release ring down firmly on both sides in order to open the holding claws uniformly and avoid scratching the hose.
2. Pull the hose straight out of the IQS plug-and-socket connection.

Mounting hose

1. Insert the hose straight into the IQS plug-and-socket connection to prevent scratching the hose.
2. Press the hose into the IQS plug-and-socket connection until you have passed both pressure points.

11) if present

9.3.2 Dismantling diaphragm head and valves

Prerequisite

- Interconnection hose removed

Required tools

- Allen key, **WAF 4**

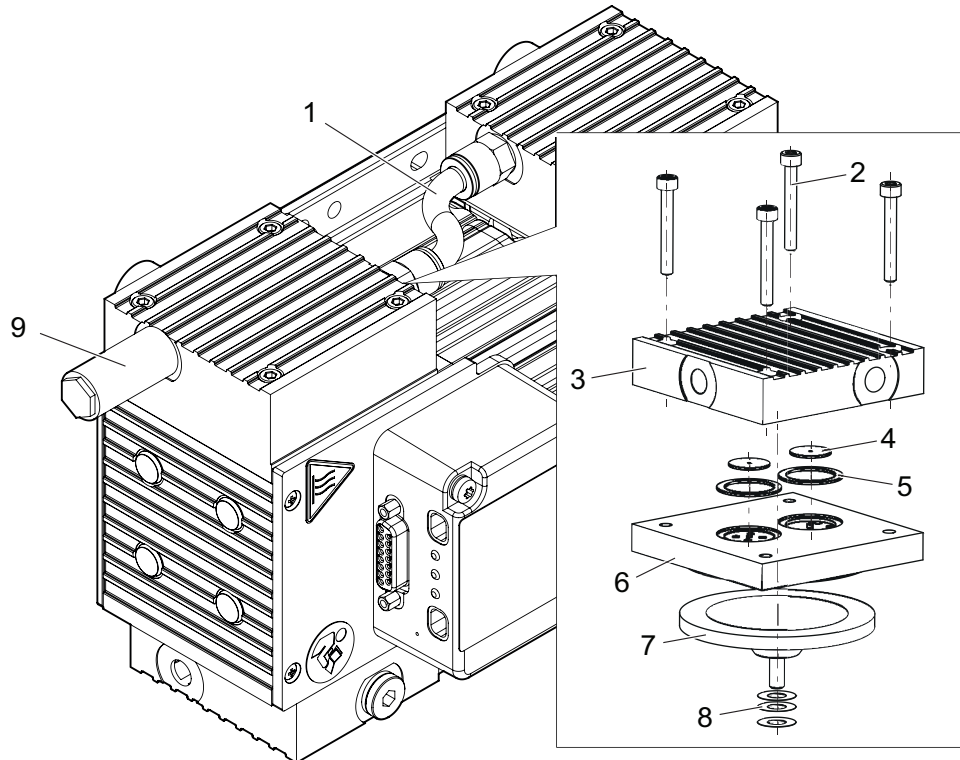

Fig. 11: Diaphragm head and valves

- | | |
|------------------------|----------------------|
| 1 Interconnection hose | 6 Intermediate plate |
| 2 Cylinder screws | 7 Diaphragm |
| 3 Diaphragm head cover | 8 Spacer disks |
| 4 Valve plate | 9 Silencer |
| 5 Sealing ring | |

Procedure

1. Place the diaphragm pump on the opposite diaphragm head.
2. Unscrew cylinder screws from the diaphragm head.
3. Remove the diaphragm head.
 - Observe the sealing ring on the intake side.
4. Remove the intermediate plate.
5. Release the valves and the sealing ring from the intermediate plate.
6. Lift the diaphragm slightly at the side.
7. Unscrew and remove the diaphragm from the connection rod by hand.
 - The diaphragm has a right-hand thread.
 - Pay attention to the spacer disks.

9.3.3 Cleaning and replacing the diaphragms and valves

Prerequisite

- Diaphragm and valves removed

Required spare parts

- Overhaul kit

Required consumables

- Clean, dry cloth
- Isopropanol

Procedure

1. Clean diaphragms and valves with a clean, dry cloth.
 - Do not use isopropanol or other cleaning agents to clean diaphragms and valves.
2. Clean valve seats, intermediate plate and head cover with isopropanol.
3. Check valve seats, intermediate plate and head cover for wear.
4. Replace all wear parts according to the inspection sets.

9.3.4 Mounting diaphragm head and valves**Spacer disks**

Spacer disks are available in 3 sizes:

- 13.0 × 6.4 × 0.5 mm
- 13.0 × 6.4 × 0.1 mm
- 16.0 × 6.4 × 0.05 mm

The number and size of the spacer disks vary between the diaphragm heads.

Install the same number and size of original spacer disks per diaphragm head.

Required tools

- Allen key, **WAF 4**

Procedure

1. Rotate the diaphragm pump so that the diaphragm head to be mounted is facing upwards.
2. Screw the diaphragm into the connection rod by hand.
 - The diaphragm has a right-hand thread.
 - Pay attention to the spacer disks.
3. Place the valves and the sealing ring in the intermediate plate.
4. Position the intermediate plate.
5. Put on the diaphragm head cover.
 - Observe the sealing ring on the intake side.
6. Screw the screws into the diaphragm head cover.
7. Mount the interconnection hose.

10 Decommissioning

Before shutting down the vacuum pump, observe the following instructions to adequately protect the interior of the vacuum pump (suction chamber) from corrosion:

Procedure for temporary vacuum pump shutdowns

1. Allow the vacuum pump to run on for 5 to 10 minutes with the vacuum connection open to allow any condensate that may be present to be removed from the vacuum pump.
2. If media has entered the vacuum pump that may attack the pump materials or lead to deposits, clean the inside of the pump heads.

Procedure for longer vacuum pump shutdowns

1. Disconnect the vacuum pump from the vacuum system.
2. Remove the vacuum pump from the vacuum system if necessary.
3. Seal the vacuum connection with the original sealing plugs.
4. Store the vacuum pump in dry, dust-free rooms, within the specified ambient conditions.
5. Pack the vacuum pump together with a drying agent in a plastic bag, and seal the vacuum pump airtight if it is to be stored in rooms with damp or aggressive atmospheres.

11 Recycling and disposal

⚠ WARNING

Health hazard through poisoning from toxic contaminated components or devices

Toxic process media result in contamination of devices or parts of them. During maintenance work, there is a risk to health from contact with these poisonous substances. Illegal disposal of toxic substances causes environmental damage.

- ▶ Take suitable safety precautions and prevent health hazards or environmental pollution by toxic process media.
- ▶ Decontaminate affected parts before carrying out maintenance work.
- ▶ Wear protective equipment.



Environmental protection

You **must** dispose of the product and its components in accordance with all applicable regulations for protecting people, the environment and nature.

- Help to reduce the wastage of natural resources.
- Prevent contamination.

11.1 General disposal information

Pfeiffer Vacuum products contain materials that you must recycle.

- ▶ Dispose of our products according to the following:
 - Iron
 - Aluminium
 - Copper
 - Synthetic
 - Electronic components
 - Oil and fat, solvent-free
- ▶ Observe the special precautionary measures when disposing of:
 - Fluoroelastomers (FKM)
 - Potentially contaminated components that come into contact with media

11.2 Dispose of diaphragm pumps

Pfeiffer Vacuum diaphragm pumps contain materials that you must recycle.

1. Disconnect the electronic drive unit.
2. Dismantle the motor.
3. Decontaminate the components that come into contact with process gases.
4. Separate the components into recyclable materials.
5. Recycle the non-contaminated components.
6. Dispose of the product or components in a safe manner according to locally applicable regulations.

12 Malfunctions

12.1 General

⚠ CAUTION

Danger of injury from moving parts

After a power failure or a standstill as a result of overheating, the motor restarts automatically. There is a risk of injury to fingers and hands if they enter the operating range of rotating parts.

- ▶ Safely disconnect motor from the mains.
- ▶ Secure the motor against reactivation.
- ▶ Dismantle the vacuum pump for inspection, away from the system if necessary.

⚠ CAUTION

Danger of burns on hot surfaces

In the event of a fault, the surface temperature of the vacuum pump can increase to above 70 °C.

- ▶ Allow the vacuum pump to cool down before carrying out any work.
- ▶ Wear personal protective equipment if necessary.

NOTICE

Danger of property damage from improper maintenance

Unprofessional work on the vacuum pump will lead to damage for which Pfeiffer Vacuum accepts no liability.

- ▶ We recommend taking advantage of our service training offering.
- ▶ When ordering spare parts, specify the information on the nameplate.

Vacuum pump and electronic drive unit malfunctions always result in a warning or error message. In both cases, you will receive an error code that you can read out via the interface of the electronic drive unit. If an error occurs, the vacuum pump switches off. Should malfunctions occur, you can find information about potential causes and how to fix them here.

Required tools

- Thin stylus for pressing the microbutton

Resetting error

1. Determine the potential cause of the error.
2. Eliminate the error.
3. Reset the error on the control unit or on the vacuum pump microbutton.

Problem	Possible causes	Remedy
Vacuum pump will not start up	<ul style="list-style-type: none"> • No supply voltage or voltage does not correspond to the motor data 	<ul style="list-style-type: none"> • Check the supply voltage.
	<ul style="list-style-type: none"> • Pump temperature too low 	<ul style="list-style-type: none"> • Heat the vacuum pump to a temperature of > 5°C.
	<ul style="list-style-type: none"> • Thermal protection of the motor has triggered 	<ul style="list-style-type: none"> • Determine and eliminate the cause. • Allow the vacuum pump to cool down as required.
	<ul style="list-style-type: none"> • Diaphragms or valves dirty 	<ul style="list-style-type: none"> • Clean the vacuum pump.
	<ul style="list-style-type: none"> • Overpressure in the exhaust line 	<ul style="list-style-type: none"> • If required, check and clean the exhaust line.

Problem	Possible causes	Remedy
Vacuum pump switches off after a while after being started	<ul style="list-style-type: none"> Thermal protection of the motor has triggered 	<ul style="list-style-type: none"> Determine and eliminate the cause. Allow the vacuum pump to cool down as required.
	<ul style="list-style-type: none"> Exhaust pressure too high 	<ul style="list-style-type: none"> Check the exhaust line outlet opening and exhaust side accessories.
Vacuum pump does not reach the specified final pressure	<ul style="list-style-type: none"> Condensate in the vacuum pump 	<ul style="list-style-type: none"> Operate the vacuum pump at atmospheric pressure for a longer period.
	<ul style="list-style-type: none"> Soiled valves or diaphragms 	<ul style="list-style-type: none"> If necessary, clean or replace the valves and diaphragms.
	<ul style="list-style-type: none"> Leak in system 	<ul style="list-style-type: none"> Locate and eliminate the leak.
Pumping speed of vacuum pump too low	<ul style="list-style-type: none"> The intake line is not suitably dimensioned 	<ul style="list-style-type: none"> Make sure that connections are short and cross sections adequately dimensioned.
	<ul style="list-style-type: none"> Exhaust pressure too high 	<ul style="list-style-type: none"> Checking exhaust line outlet opening and exhaust side accessories.
Unusual noises during operation	<ul style="list-style-type: none"> Defective valves or diaphragms 	<ul style="list-style-type: none"> If necessary, clean or replace the valves and diaphragms.
	<ul style="list-style-type: none"> Soiled suction chamber 	<ul style="list-style-type: none"> Clean suction chamber.
	<ul style="list-style-type: none"> The silencer is loose or missing 	<ul style="list-style-type: none"> If necessary, check or replace the silencer.
	<ul style="list-style-type: none"> Valves dirty or defective 	<ul style="list-style-type: none"> If necessary, clean or replace the valves and diaphragms.
	<ul style="list-style-type: none"> Connection rod or motor bearing defective 	<ul style="list-style-type: none"> Contact Pfeiffer Vacuum Service.

Tbl. 21: Troubleshooting on diaphragm pumps

12.2 Error codes

Errors (** Error E—— **) always cause the vacuum pump to be switched off.

Warnings (* Warning F —— *) do not cause the vacuum pump to be switched off.

Handling malfunction messages

1. Read out error codes via Pfeiffer Vacuum control units or a PC.
2. Remove the cause of the malfunction.
3. Reset the malfunction message with parameter **[P:009]**.
 - Use preconfigured interfaces or screen tiles on Pfeiffer Vacuum control units.

Error code	Problem	Possible causes	Remedy
Err021	Vacuum pump unknown	Software error	<ul style="list-style-type: none"> Contact Pfeiffer Vacuum Service
Err042	Inconsistent software	Checksum errors	<ul style="list-style-type: none"> Contact Pfeiffer Vacuum Service
Err044	Electronics excess temperature ($\geq 80^{\circ}\text{C}$)	Insufficient cooling	<ul style="list-style-type: none"> Improve the cooling Check the operating conditions
Err091	Unknown hardware	-	<ul style="list-style-type: none"> Contact Pfeiffer Vacuum Service
Err094	Electronics temperature impermissible	Temperature $<25^{\circ}\text{C}$ or $>125^{\circ}\text{C}$	<ul style="list-style-type: none"> Check the operating conditions
Err098	Internal communication error between interface board and drive	–	<ul style="list-style-type: none"> Contact Pfeiffer Vacuum Service
Err117	Vacuum pump excess temperature ($> 85^{\circ}\text{C}$)	Insufficient cooling	<ul style="list-style-type: none"> Improve the cooling Check the operating conditions
Err173	Vacuum pump overcurrent	-	<ul style="list-style-type: none"> Contact Pfeiffer Vacuum Service
Err174	Vacuum pump blocked	–	<ul style="list-style-type: none"> Contact Pfeiffer Vacuum Service

Tbl. 22: Error messages for vacuum pump

Malfunctions

Error code	Problem	Possible causes	Remedy
Wrn042	Maintenance	-	<ul style="list-style-type: none"> • Service the vacuum pump. • Reset the error on the vacuum pump microbutton.
Wrn044	Electronics high temperature ($\geq 70^{\circ}\text{C}$)	<ul style="list-style-type: none"> • Insufficient cooling 	<ul style="list-style-type: none"> • Improve the cooling • Check the operating conditions
Wrn117	Vacuum pump high temperature ($\geq 75^{\circ}\text{C}$)	<ul style="list-style-type: none"> • Insufficient cooling 	<ul style="list-style-type: none"> • Improve the cooling • Check the operating conditions

Tbl. 23: Warning messages for vacuum pump

13 Service solutions by Pfeiffer Vacuum

We offer first-class service

High vacuum component service life, in combination with low downtime, are clear expectations that you place on us. We meet your needs with efficient products and outstanding service.

We are always focused on perfecting our core competence – servicing of vacuum components. Once you have purchased a product from Pfeiffer Vacuum, our service is far from over. This is often exactly where service begins. Obviously, in proven Pfeiffer Vacuum quality.

Our professional sales and service employees are available to provide you with reliable assistance, worldwide. Pfeiffer Vacuum offers an entire range of services, from [original replacement parts](#) to [service contracts](#).

Make use of Pfeiffer Vacuum service

Whether preventive, on-site service carried out by our field service, fast replacement with mint condition replacement products, or repair carried out in a [Service Center](#) near you – you have various options for maintaining your equipment availability. You can find more detailed information and addresses on our homepage, in the section.

You can obtain advice on the optimal solution for you, from your [Pfeiffer Vacuum representative](#).

For fast and smooth service process handling, we recommend the following:



1. Download the up-to-date form templates.
 - [Explanations of service requests](#)
 - [Service requests](#)
 - [Contamination declaration](#)



- a) Remove and store all accessories (all external parts, such as valves, protective screens, etc.).
 - b) If necessary, drain operating fluid/lubricant.
 - c) If necessary, drain coolant.
2. Complete the service request and contamination declaration.



3. Send the forms by email, fax, or post to your local [Service Center](#).



4. You will receive an acknowledgment from Pfeiffer Vacuum.

PFEIFFER VACUUM

Submission of contaminated products

No microbiological, explosive, or radiologically contaminated products will be accepted. Where products are contaminated, or the contamination declaration is missing, Pfeiffer Vacuum will contact you before starting service work. Depending on the product and degree of pollution, **additional decontamination costs** may be incurred.

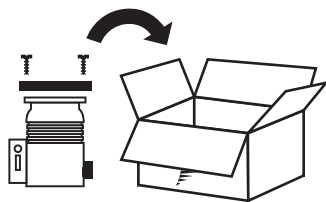

5. Prepare the product for transport in accordance with the provisions in the contamination declaration.
 - a) Neutralize the product with nitrogen or dry air.
 - b) Seal all openings with blind flanges, so that they are airtight.
 - c) Shrink-wrap the product in suitable protective foil.
 - d) Package the product in suitable, stable transport containers only.
 - e) Maintain applicable transport conditions.

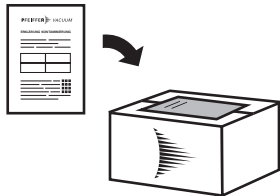

6. Attach the contamination declaration to the **outside** of the packaging.

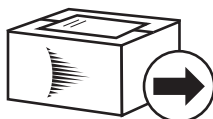

7. Now send your product to your local Service Center.

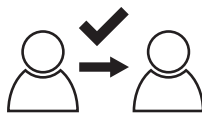

8. You will receive an acknowledgment/quotation, from Pfeiffer Vacuum.

PFEIFFER VACUUM

Our sales and delivery conditions and repair and maintenance conditions for vacuum devices and components apply to all service orders.

14 Spare part packages

Ordering spare part packages

- ▶ Have the vacuum pump part number to hand, along with other details from the rating plate if necessary.
- ▶ Install original spare parts only.
- ▶ When ordering the inspection set, observe the respective part number of the diaphragm pump.

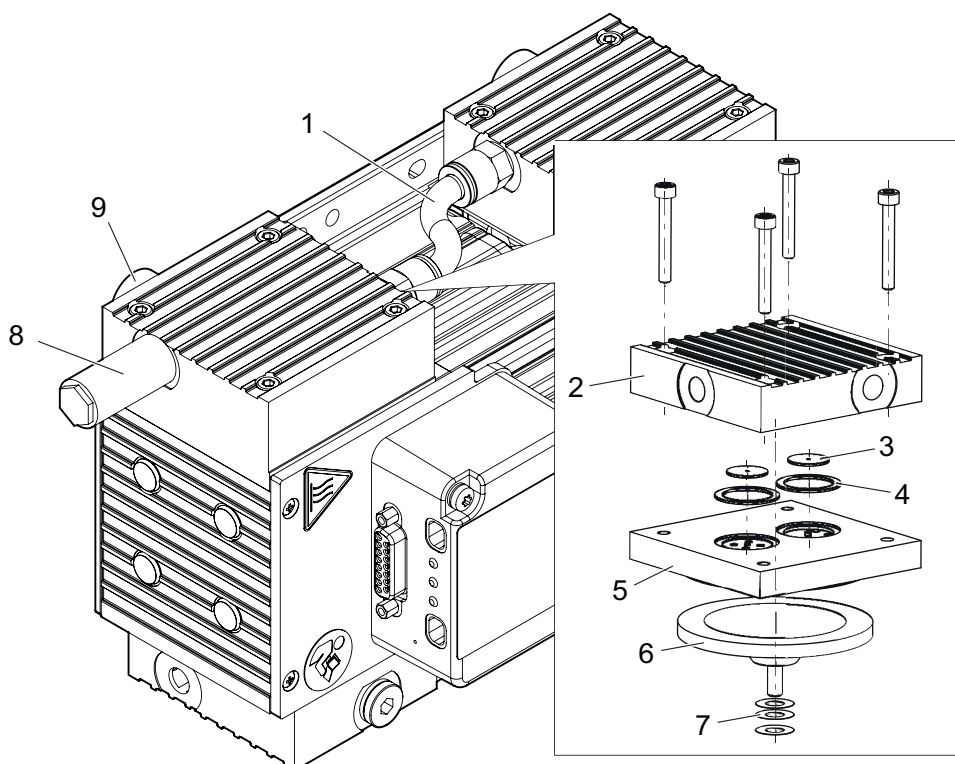

Fig. 12: Spare parts

- | | |
|-----------------------------|----------------|
| 1 Interhead connection (2×) | 6 Diaphragm |
| 2 Head cover | 7 Spacer disks |
| 3 Valve plate | 8 Silencer |
| 4 Sealing ring | 9 Rubber feet |
| 5 Intermediate plate | |

Spare parts	Order number	comprising the following parts
Overhaul kit for MVP 015-4 DC structure diaphragm Typ 2	PU E22 031 -T	3, 4, 6 (complete)
Silencer for MVP Neo R 1/8"	PK 050 368	8
Spare part package head cover for MVP 015-4 DC Neo	PU E22 040 -T	2
Spare parts package intermediate plate for MVP 015-4 DC Neo	PU E22 033 -T	5
Spare parts package rubber feet for MVP 015-4 DC Neo	PU E22 041 -T	9
Interhead connection for MVP 015 1/8" thread	PK 050 327	Interhead connection, angled
Interhead connection for MVP 015-4 DC 1/8" thread	PK 050 336	Interhead connection, straight

Tbl. 24: Spare parts

15 Accessories

15.1 Accessory information

Control unit

Universal control unit for all products with Pfeiffer Vacuum RS-485 protocol.

Power supply packs

Power supply packs for fastening to the wall and standard rails or for rack assembly serve the voltage supply.

Cable and adapter

Mains, interface, connection, and extension cables provide a secure and suitable connection. Different lengths on request

Hose connections

Hose connections with adapters for connecting to a turbopump

Screw-in flange

Screw-in flange, including seal for the intake side of the vacuum pump

15.2 Ordering accessories



OmniControl variants

You can find additional OmniControl variants on the [Pfeiffer Vacuum website](#).

Part number	Selection field
P 0920 739	Hose connection DN 6 x 400 mm with straight connector 1/8" thread and 1/4" thread including seal
P 0920 817	Hose connection DN 6 x 1000 mm with straight connector 1/8" thread and 1/4" thread including seal
P 0991 939	Hose DN 6; (ø 8/6 mm) polyethylene
P 4131 026	Push-in fitting 1/8" thread including seal for hose connection (8/6 mm)
P 4131 029	Push-in fitting G 1/8" including seal for hose connection (8/6 mm)
P 4131 030	Push-in T-fitting 1/8" thread including seal for hose connection (8/6 mm)
P 4723 010	Y-connector M12 for RS-485
PE 100 013 -T	Connection cable MVP-TC-TPS, 3 m
PE D20 000 0	OmniControl 001 Mobile, control units
PE D40 000 0	OmniControl 001, rack unit without integrated power supply pack
PE D50 000 0	OmniControl 200, rack unit with integrated power supply pack
PK 050 108 -T	Screwing flange DN 16 ISO-KF / 1/8" thread incl. seal
PK 050 304 -U	Flushing gas nozzle with filter for MVP 015-4 / MVP 020-3 / MVP 030-3
PK 050 363 -U	Automated gas ballast valve, 24 V DC, G 1/8"
PM 061 207 -T	USB RS-485 converter
PM 061 283 -T	Interface cable, M12 m straight / M12 m straight, 3 m
PM 061 341 -T	TPS 180, power supply pack for wall/standard rail installation
PM 061 345 -T	TPS 181, power supply pack 19" plug-in unit 3HU
PM 061 350 -T	Connecting cable from 24V/48V power supply pack to electronic drive unit. With RS-485 interface
PM 061 543 -T	Connection cable for HiPace with TC 110/120

Tbl. 25: Accessories MVP 015-4 DC

16 Technical data and dimensions

16.1 General

Basis for the technical data of Pfeiffer Vacuum diaphragm pumps:

- Specifications according to PNEUROP committee PN5
- ISO 21360:2012: "Vacuum technology - Standard methods for measuring vacuum-pump performance - General description"

The following harmonized standards are fulfilled:

- IEC 61010-1
- UL 61010-1
- CSA 61010-1

	mbar	bar	Pa	hPa	kPa	Torr mm Hg
mbar	1	$1 \cdot 10^{-3}$	100	1	0.1	0.75
bar	1000	1	$1 \cdot 10^5$	1000	100	750
Pa	0.01	$1 \cdot 10^{-5}$	1	0.01	$1 \cdot 10^{-3}$	$7.5 \cdot 10^{-3}$
hPa	1	$1 \cdot 10^{-3}$	100	1	0.1	0.75
kPa	10	0.01	1000	10	1	7.5
Torr mm Hg	1.33	$1.33 \cdot 10^{-3}$	133.32	1.33	0.133	1

1 Pa = 1 N/m²

Tbl. 26: Conversion table: Pressure units

	mbar l/s	Pa m ³ /s	sccm	Torr l/s	atm cm ³ /s
mbar l/s	1	0.1	59.2	0.75	0.987
Pa m ³ /s	10	1	592	7.5	9.87
sccm	$1.69 \cdot 10^{-2}$	$1.69 \cdot 10^{-3}$	1	$1.27 \cdot 10^{-2}$	$1.67 \cdot 10^{-2}$
Torr l/s	1.33	0.133	78.9	1	1.32
atm cm ³ /s	1.01	0.101	59.8	0.76	1

Tbl. 27: Conversion table: Units for gas throughput

16.2 Technical data

Type designation	MVP 015-4 DC Neo	MVP 015-4 DC Neo
Part number	PK T05 163	PK T05 164
Number of pumping stages	Four stage	Four stage
Connection flange (in)	G 1/8"	G 1/8"
Connection flange (out)	1/8" thread with silencer	1/8" thread with silencer
Pumping speed	0.8 m ³ /h	0.8 m ³ /h
Gas ballast	Available as an accessory	Available as an accessory
Final pressure	$5 \cdot 10^{-1}$ hPa	$5 \cdot 10^{-1}$ hPa
Intake pressure max.	1100 hPa	1100 hPa
Exhaust pressure, max.	1100 hPa	1100 hPa
Integral leak rate	$5 \cdot 10^{-4}$ Pa m ³ /s	$5 \cdot 10^{-4}$ Pa m ³ /s
I/O interfaces	RS485	RS485
Input voltage(s)	24 V DC (±10 %)	24 V DC (±10 %)
Rated current consumption	3.3 A	3.3 A
Current, max.	6.8 A	6.8 A
Short circuit current of voltage source, max.	45 A	45 A

Type designation	MVP 015-4 DC Neo	MVP 015-4 DC Neo
Nominal rotation speed	1500 rpm	1500 rpm
Rotation speed	750 – 1 800 rpm	750 – 1 800 rpm
Cooling method	Natural convection	Natural convection
Operating altitude, max.	2000 m	2000 m
Protection degree	IP20	IP20
Ambient temperature	5 – 40 °C	5 – 40 °C
Temperature: Storage	5 – 40 °C	5 – 40 °C
Temperature: Shipping	-10 – 60 °C	-10 – 60 °C
Sound pressure level	49 dB(A)	49 dB(A)
Switch	No	No
Mains cable included	No	No
Weight	4.4 kg	4.4 kg

Tbl. 28: Technical data MVP 015-4 DC

16.3 Substances in contact with the media

Pump parts	Substances in contact with the media
Diaphragm	EPDM
Valves	EPDM
Head cover	Aluminum
Hose connection	PVC
Push-in fitting	CuZn, nickel-plated
Straight compression coupling on the suction hose	CuZn, nickel-plated
Suction hose	PE
Exhaust, silencer	PA

Tbl. 29: Materials that make contact with the process media

16.4 Dimensions

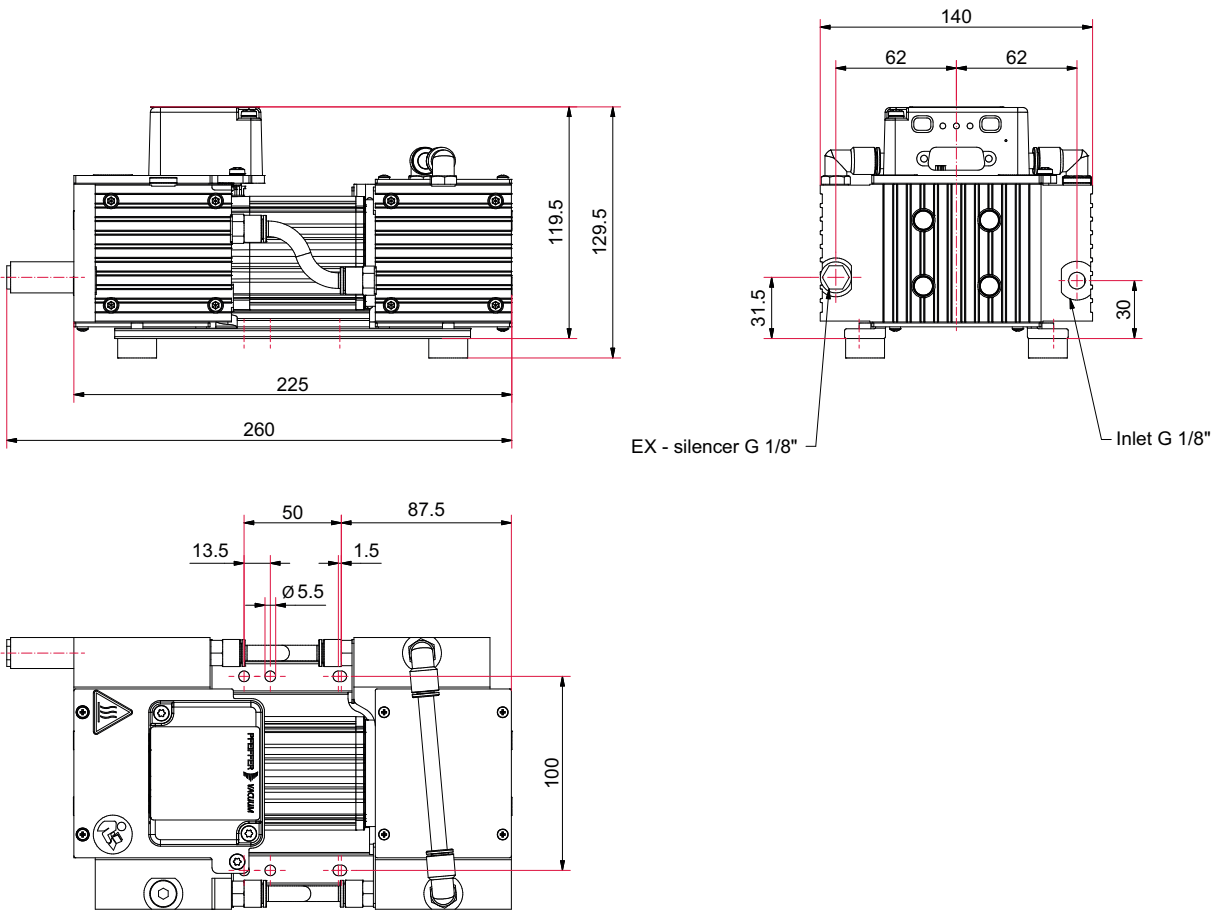
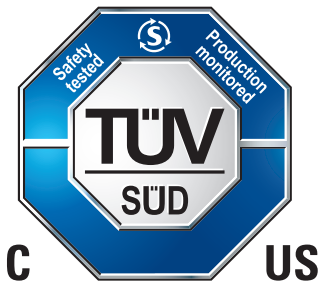

Fig. 13: Dimensions MVP 015-4 DC
Dimensions in mm



The product MVP 015-4 DC

- conforms to the UL standards

UL 61010-1:2012/R:2015-07

Safety requirements for electrical equipment for measurement, control and laboratory use
Part 1: General requirements

- is certified to the CAN/CSA standards

CAN/CSA-C22.2 No. 61010-1:2012/U1:2015-07

Safety requirements for electrical equipment for measurement, control and laboratory use
Part 1: General requirements

EC Declaration of Conformity

Declaration for product(s) of the type:

Diaphragm pump

MVP 015-4 DC Neo

We hereby declare that the listed product satisfies all relevant provisions of the following **European Directives**.

Machinery 2006/42/EC (Annex II, no. 1 A)

Electromagnetic compatibility 2014/30/EU

Restriction of the use of certain hazardous substances 2011/65/EU

Restriction of the use of certain hazardous substances, delegated directive 2015/863/EU

Harmonized standards and applied national standards and specifications:

EN 61010-1:2010 + A1:2019 + A1:2019/AC:2019

EN IEC 61000-6-2:2019

EN 1012-2:1996 + A1:2009

EN IEC 61000-6-3:2021

EN ISO 12100:2010

EN IEC 63000:2018

EN IEC 61326-1:2021 class A

The authorized representative for the compilation of technical documents is
Dr. Adrian Wirth, Pfeiffer Vacuum GmbH, Berliner Straße 43, 35614 Asslar, Germany.

Signature:



Pfeiffer Vacuum GmbH
Berliner Straße 43
35614 Asslar
Germany

(Daniel Sälzer)
Managing Director

Asslar, 2024-03-04



UK Declaration of Conformity

This declaration of conformity has been issued under the sole responsibility of the manufacturer.

Declaration for product(s) of the type:

Diaphragm pump

MVP 015-4 DC Neo

We hereby declare that the listed product satisfies all relevant provisions of the following **British Directives**.

Supply of Machinery (Safety) Regulations 2008

Electromagnetic Compatibility Regulations 2016

The Restriction of the Use of Certain Hazardous Substances in Electrical and Electronic Equipment Regulations 2012

Applied standards and specifications:

EN 61010-1:2010 + A1:2019 + A1:2019/AC:2019

EN IEC 61000-6-2:2019

EN 1012-2:1996 + A1:2009

EN IEC 61000-6-3:2021

EN ISO 12100:2010

EN IEC 63000:2018

EN IEC 61326-1:2021 class A

The manufacturer's authorized representative in the United Kingdom and the authorized agent for compiling the technical documentation is Pfeiffer Vacuum Ltd, 16 Plover Close, Interchange Park, MK169PS Newport Pagnell.

Signature:



(Daniel Sälzer)
Managing Director

Pfeiffer Vacuum GmbH
Berliner Straße 43
35614 Asslar
Germany

Asslar, 2024-03-04

**UK
CA**



VACUUM SOLUTIONS FROM A SINGLE SOURCE

Pfeiffer Vacuum stands for innovative and custom vacuum solutions worldwide, technological perfection, competent advice and reliable service.

COMPLETE RANGE OF PRODUCTS

From a single component to complex systems:

We are the only supplier of vacuum technology that provides a complete product portfolio.

COMPETENCE IN THEORY AND PRACTICE

Benefit from our know-how and our portfolio of training opportunities!

We support you with your plant layout and provide first-class on-site service worldwide.

ed. A - Date 2403 - P/N:PU0107BEN



Are you looking for a
perfect vacuum solution?
Please contact us

Pfeiffer Vacuum GmbH
Headquarters • Germany
T +49 6441 802-0
info@pfeiffer-vacuum.de

www.pfeiffer-vacuum.com

PFEIFFER  **VACUUM**